

Plate Dining Table

Developed by Vitra in Switzerland
Design: Jasper Morrison



Assembly instructions
Montageanleitung
Notice de montage
Instrucciones de montaje
Montagehandleiding
Istruzioni per il montaggio

vitra.

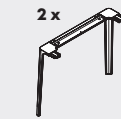
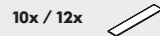
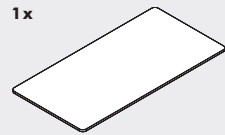
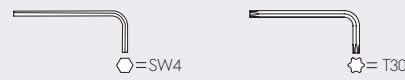

1

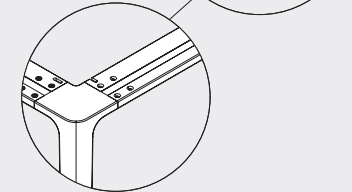
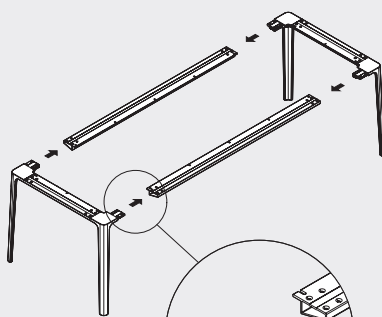

2

16 x

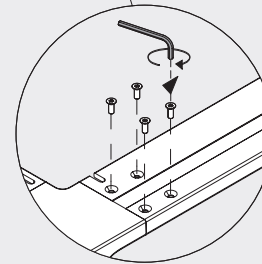
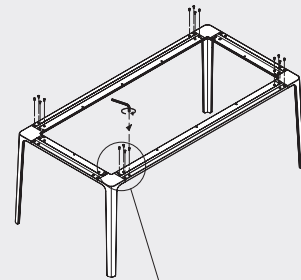

3a

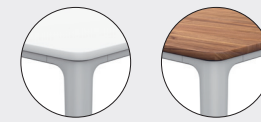

1 x

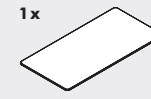

16 x

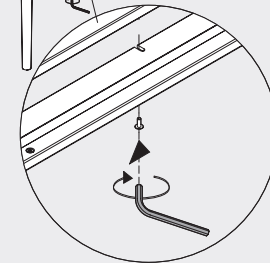
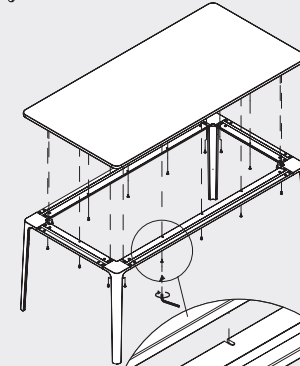

3b



1600mm x 800mm
1800mm x 900mm
2000mm x 900mm
2200mm x 1000mm



2400mm x 1000mm

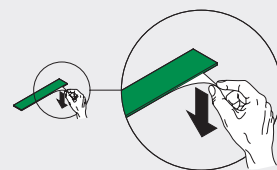
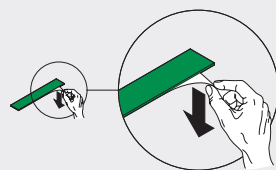

10 x

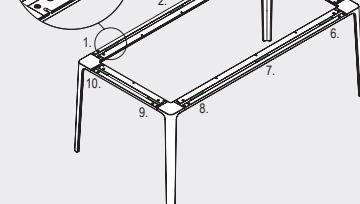
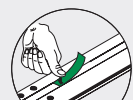

12 x

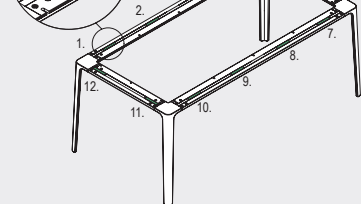
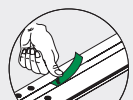

1 x

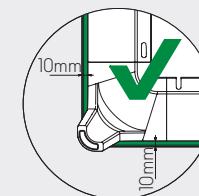
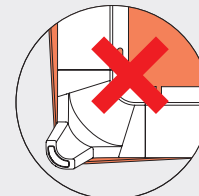
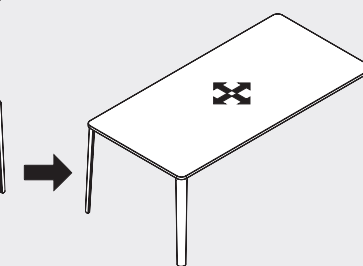
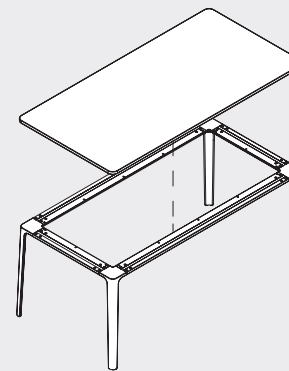
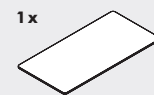

EN Care instructions: Use a soft damp cloth and a mild neutral detergent to treat stains on the surface. Please see the accompanying wood brochure for wood products. In the case of marble, follow the enclosed care instructions for marble. For further care instructions please consult your dealer, for stubborn stains please consult a specialist. We recommend always using environmentally friendly cleaning agents.

DE Pflegehinweise: Verwenden Sie zur Behandlung von Flecken auf der Oberfläche ein feuchtes weiches Tuch und ein mildes, neutrales Reinigungsmittel. Bei Holz beachten Sie die beiliegende Holzbrochure. Bei Marmor beachten Sie den beiliegenden Pflegehinweis für Marmor. Für weitere Pflegehinweise wenden Sie sich an Ihren Fachhandelspartner, bei hartnäckigen Flecken an einen Fachbetrieb. Wir empfehlen grundsätzlich den Einsatz umweltfreundlicher Reinigungsmittel.

FR Conseils d'entretien : Utilisez un chiffon doux humide et un produit d'entretien doux et neutre pour nettoyer d'éventuelles taches sur la surface. Pour tout ce qui concerne le bois, veuillez vous reporter à la brochure Bois ci-jointe. S'il s'agit de marbre, veuillez vous référer aux instructions d'entretien pour le marbre ci-jointes. Pour obtenir de plus amples informations au sujet de l'entretien, veuillez contacter votre revendeur. En cas de taches tenaces, demandez conseil à un spécialiste. D'une manière générale, nous recommandons d'utiliser des nettoyeurs écologiques.

ES Pautas de conservación: Para limpiar la superficie utilice un paño suave humedecido y un producto de limpieza neutro que no sea agresivo. Para los elementos de madera, consulte el folleto adjunto. Para el mármol tenga en cuenta la instrucción de cuidado para mármol adjunta. Si desea más información sobre los procedimientos de conservación, póngase en contacto con su distribuidor; en caso de manchas persistentes, consulte a un especialista. Como norma general, recomendamos utilizar productos de limpieza que no dañen el medio ambiente.

NL Onderhoudsinstructies: Gebruik voor de behandeling van vlekken op het oppervlak een vochtige, zachte doek en een mild, neutraal reinigingsmiddel. Neem voor het onderhoud van hout de instructies in de bijgevoegde brochure in acht. Voor marmer: zie de bijgevoegde onderhoudsinstructies voor marmer. Raadpleeg voor verdere onderhoudsinstructies uw specialzaak, en bij hardnekkige vlekken een gespecialiseerd bedrijf. Wij raden in principe het gebruik van milieuvriendelijke reinigingsproducten aan.

IT Consigli per la manutenzione: Per eliminare le macchie dalla superficie utilizzare un panno morbido e umido e un detersivo delicato e neutro. Per il legno si prega di osservare la brochure allegata dedicata al legno. Per il marmo osservare l'avvertenza per la manutenzione allegata per questo materiale. Per ulteriori consigli di manutenzione si prega di rivolgersi al proprio rivenditore e, in caso di macchie ostinate, ad un'azienda specializzata. Si raccomanda vivamente l'utilizzo di detersivi ecocompatibili.

