

mater



**Considering the planet,
its resources and its people.**

@materdesign

www.materdesign.com

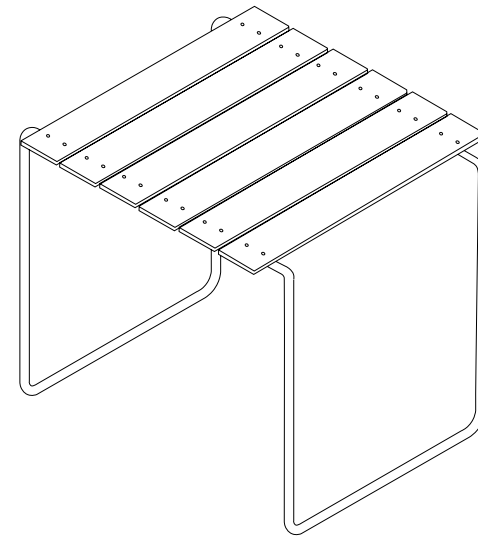

Ocean OC2 Table, 2 pers.

Designed by Jørgen & Nanna Ditzel

Thank you for purchasing the Ocean OC2 Table

Ocean OC2 Table, 2 pers.

Discarded plastic beer kegs & upcycled hard plastic



Designed by
Jørgen & Nanna Ditzel

Dimensions
W 70 cm D 70 cm H 74 cm /
W 28" D 28" H 29"

Weight
9.1 kg / 19 lbs

Materials
Slats made from discarded beer kegs mixed with upcycled hard plastic. One table contains 1224g / 43.2oz beer keg plastic waste

Steel tube, partly upcycled steel,
Gun metal finish

Gliders
Hard plastic gliders installed as standard

Maintenance guide

The products in the Ocean OC2 Collection have an outdoor primer which provides a barrier to corrosive elements making it suitable for outdoor use and designed to last. All products in the Ocean OC2 Collection are handcrafted and minor blemishes and imperfections may be visible. These are not considered defects and do not interfere with the quality and function of the product. Always remove stains quickly before they can do any permanent damage to the furniture. When you move your furniture, make sure you lift it rather than pulling or pushing it to avoid damaging the floor, legs and mountings.

On chairs, avoid improper use such as sitting on the back or armrests, tilting the seats on their back legs, putting your feet on the furniture or standing on it. On tables tighten up the screws after one or two months use. Be careful not to damage or scratch the surface with sharp objects. Minor spots of rust under the furniture and bases are considered as a natural result of general use and can be treated using the care instructions. Direct placement on a seafront can lead to corrosion. Wipe off bird droppings quickly as they may lead to staining or permanent corrosion

Wipe off the furniture if it becomes wet after rain or snowfall as this will damage the surface over time. Sharp tips and points can also appear on the surface, which can be removed with a metal file. Take care not to scratch the chairs against each other when stacking them. Do not move or drag the chairs around when stacked as the weight will damage the legs.

Powder Coated Steel

Wipe with a clean cloth wrung in water or in a solution of water and a neutral detergent. Remove soap residue immediately using a clean dry cloth. Avoid using scouring cream or scouring pads, as they may scratch the surface. Minor scratches or damage to the powder coated surfaces can lead to corrosion.

Storage

The life expectancy of your furniture will vary depending on the weather and type of use. We recommend that you store it in a dry, ventilated place during winter and keep it protected from scratches and bumps.

Assembly instructions

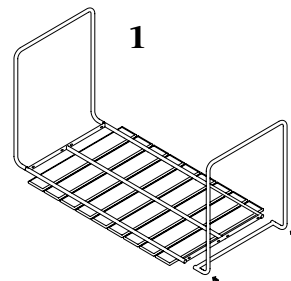

2

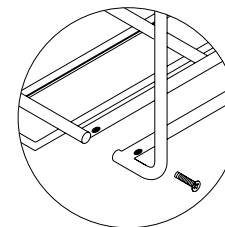

Place the table top downwards on a carpet or another surface that does not scratch the lamellas. Put the steel base and table top together with the A bolt, washer and nut.

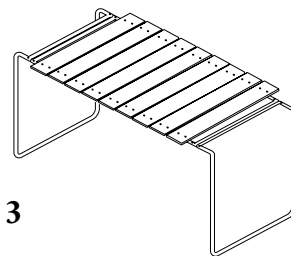

4

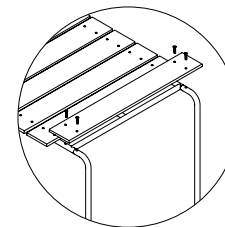

When the steel base and table top are put together, screw the last two lamellas on with the B screws

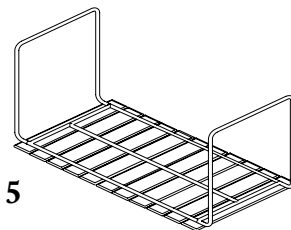

6

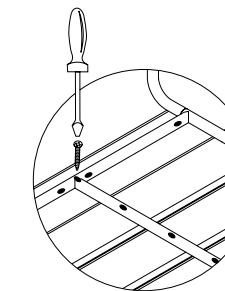

Turn around the table again, and screw the last two C screws to the backside of the two lamellas.

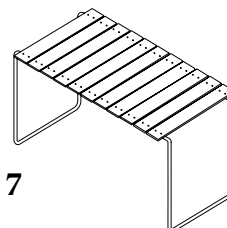

Well done!
Now your new Ocean table is ready for use. Remember to follow the cleaning and care instructions to make sure that it stays in the best shape for as long as possible



**Considering the planet,
its resources and its people.**

@materdesign

www.materdesign.com

mater

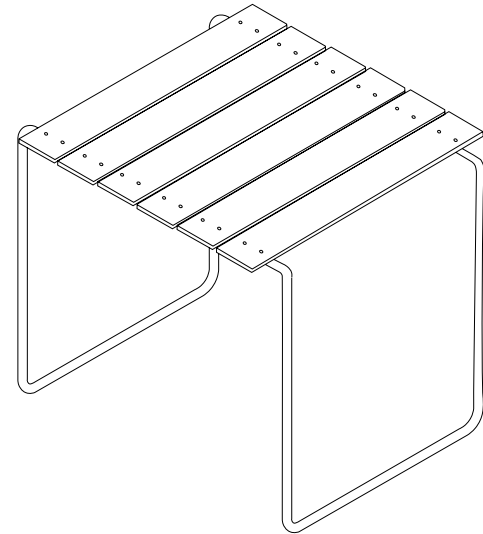

Ocean Table, 2 pers.

Designed by Jørgen & Nanna Ditzel

Thank you for purchasing the Ocean Table

Ocean Table, 2 pers.

Discarded fishing nets & upcycled hard plastic



Designed by
Jørgen & Nanna Ditzel

Dimensions
W 70 cm D 70 cm H 74 cm /
W 28" D 28" H 29"

Weight
9.1 kg / 19 lbs

Materials
Slats made from discarded fishing nets mixed with upcycled hard plastic. One table contains 1440g / 50.7oz ocean waste plastic.

Steel tube, partly upcycled steel,
Gun metal finish

Gliders
Hard plastic gliders installed as standard

Maintenance guide

The products in the Ocean Collection have an outdoor primer which provides a barrier to corrosive elements making it suitable for outdoor use and designed to last. All products in the Ocean Collection are handcrafted and minor blemishes and imperfections may be visible. These are not considered defects and do not interfere with the quality and function of the product. Always remove stains quickly before they can do any permanent damage to the furniture. When you move your furniture, make sure you lift it rather than pulling or pushing it to avoid damaging the floor, legs and mountings.

On chairs, avoid improper use such as sitting on the back or armrests, tilting the seats on their back legs, putting your feet on the furniture or standing on it. On tables tighten up the screws after one or two months use. Be careful not to damage or scratch the surface with sharp objects. Minor spots of rust under the furniture and bases are considered as a natural result of general use and can be treated using the care instructions. Direct placement on a seafront can lead to corrosion. Wipe off bird droppings quickly as they may lead to staining or permanent corrosion

Wipe off the furniture if it becomes wet after rain or snowfall as this will damage the surface over time. Sharp tips and points can also appear on the surface, which can be removed with a metal file. Take care not to scratch the chairs against each other when stacking them. Do not move or drag the chairs around when stacked as the weight will damage the legs.

Powder Coated Steel

Wipe with a clean cloth wrung in water or in a solution of water and a neutral detergent. Remove soap residue immediately using a clean dry cloth. Avoid using scouring cream or scouring pads, as they may scratch the surface. Minor scratches or damage to the powder coated surfaces can lead to corrosion.

Storage

The life expectancy of your furniture will vary depending on the weather and type of use. We recommend that you store it in a dry, ventilated place during winter and keep it protected from scratches and bumps.

Assembly instructions

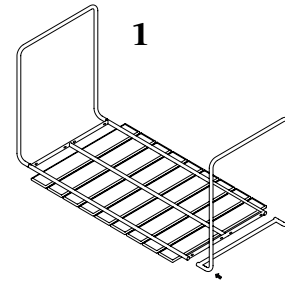

2

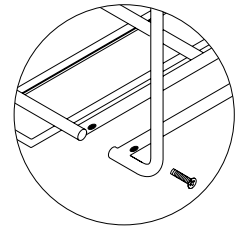

Place the table top downwards on a carpet or another surface that does not scratch the lamellas. Put the steel base and table top together with the A bolt, washer and nut.

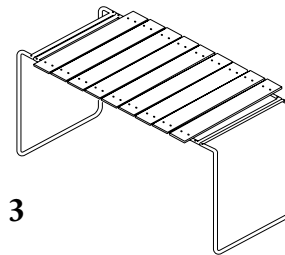

4

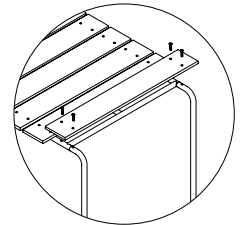

When the steel base and table top are put together, screw the last two lamellas on with the B screws

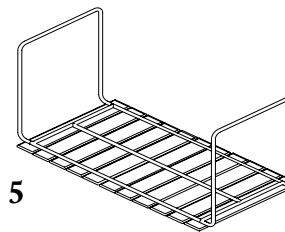

6

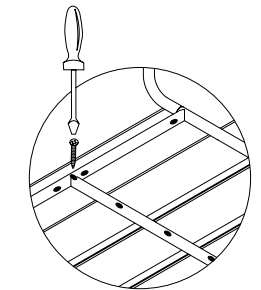

Turn around the table again, and screw the last two C screws to the backside of the two lamellas.

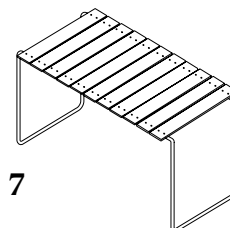

Well done!

Now your new Ocean table is ready for use. Remember to follow the cleaning and care instructions to make sure that it stays in the best shape for as long as possible