

ASSEMBLY GUIDE F-Cabinet

In this box you will find:

1×F-cabinet, 2×wall cleats, 16×Spacers, 6×Screws, 6 wall anchors

Necessary Tools: Screwdriver, Level



6× SCREW + WALL ANCHOR
* ensure appropriate for wall

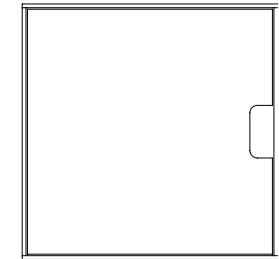

1×F-CABINET

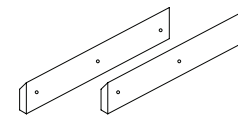

2×WALL CLEATS



16×SPACERS



LEVEL

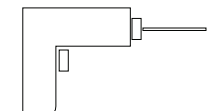

SCREWDRIVER

1. Remove F-Cabinet and its two wall cleats from packaging, if larger cabinet remove interior shelves.
2. Place wall cleats on the wall in desired position, ensure with a leveler they are mounted in a straight horizontal angle. Take care to use the proper wall anchors, and drill the two cleats to the wall.

1.

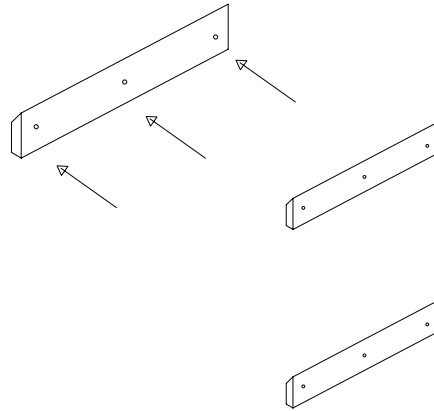

4. (Large cabinet) Using the interior holes placed on the sides of the F-Cabinet, place four spacers with the washer facing within the interior side. Place shelf atop.

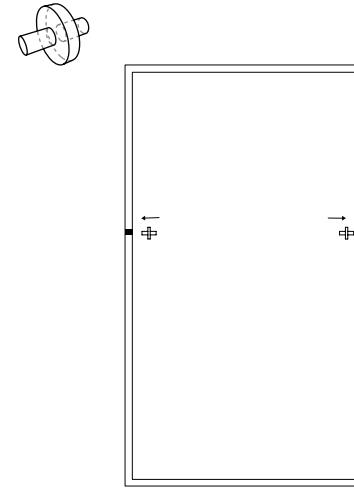

- 3.a. Place the backside of F-Cabinet with opposite facing wall cleats on the newly mounted wall cleats.

NOTE: Customer can choose if the cabinet opens left or right, as attached cleats are double sided on cabinet.

- 3.b. Lift the cabinet up and down on to the cleats, so that they lock into place.

2.a.

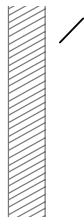

2.b.

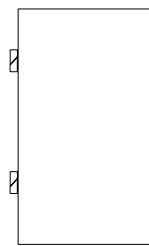

SIDE VIEW MOUNTED

5. If placing multiple F-Cabinets in an arrangement, use spacers to stack the cabinets. Place the four spacers on top of the first mounted cabinet before properly wall mounting the next cabinet on top.

