

**VERGE**

ARCHITECTURAL  
CERAMICS 



# VERGE

5"X5" | 12,5X12,5 cm



VERGE Graphite Matte



TECHNICAL



Available colors / Colores disponibles

Packing / Encajado

Ice White  
Matte

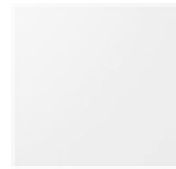

Ice White  
Gloss



Natural  
Matte









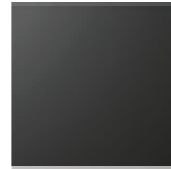

Ash Grey  
Matte



Graphite  
Matte



			 KG  LB		 M2  FT2			 M2  FT2	
Tamaño (cm)	Size (in)	Piezas / Caja Pieces / Box	Kg / Caja	Lb/ box	m2 / Caja	sq ft / Box	Cajas / Palet Boxes / Pallet	m2 / Palet	sq ft / Pallet
12,5x12,5	5"x5"	22	6,993	15.417	0,340	3.660	102	34,680	373.320

TECHNICAL FEATURES FOR DRY-PRESSED CERAMIC TILES WITH WATER ABSORPTION B Ia ( $\leq 0,5\%$ ) & BIII ( $E_b > 10\%$ )  
 CARACTERÍSTICAS TÉCNICAS PARA LAS BALDOSAS CERÁMICAS PRENSADAS EN SECO CON ABSORCIÓN DE AGUA B Ia ( $\leq 0,5\%$ ) & BIII ( $E_b > 10\%$ )

FEATURES / CARACTERÍSTICAS	SPECIFICATION / ESPECIFICACIÓN	NORMA
----------------------------	--------------------------------	-------











Dimensional Features      Verge      (W 124,3 mm +/- 0,5% x 124,3 mm +/- 0,5% x h. 26 mm) GL

UNE-EN ISO 10545-2: 1998

TECHNICAL FEATURES FOR DRY-PRESSED CERAMIC TILES WITH WATER ABSORPTION B Ia ( $\leq 0,5\%$ ) & BIII ( $E_b > 10\%$ )  
 CARACTERÍSTICAS TÉCNICAS PARA LAS BALDOSAS CERÁMICAS PRENSADAS EN SECO CON ABSORCIÓN DE AGUA B Ia ( $\leq 0,5\%$ ) & BIII ( $E_b > 10\%$ )

FEATURES / CARACTERÍSTICAS	SPECIFICATION / ESPECIFICACIÓN	NORMA
----------------------------	--------------------------------	-------

	Water absorption	White body Porcelain Concrete	$> 10\%$ $\leq 0,5\%$ $> 10\%$	UNE-EN ISO 10545-3:1997
	Modulus of rupture and breaking strength	White body Porcelain	Minimum 15 N/mm <sup>2</sup> Individual Minimum 12 N/mm <sup>2</sup> Minimum 35 N/mm <sup>2</sup> Individual Minimum 32 N/mm <sup>2</sup>	UNE-EN ISO 10545-4: 2012
	Crazing resistance	White body Porcelain	Pass Pass	UNE-EN ISO 10545-11:1997
	Household products resistance	White body Porcelain	GA UA	UNE-EN ISO 10545-13:1998
	Chemical resistance	White body Porcelain	GLA ULA	UNE-EN ISO 10545-13:1998
	Stain resistance	White body Porcelain	5 >3	UNE-EN ISO 10545-14:1998
	Frost resistance	Porcelain Concrete	Porcelain Pass	UNE-EN ISO 10545-12:1997
	Non-slip value		R10 / CLASS 3 DCOF >0,60	DIN 51130:2014 ANSI A137.1:2012
	Colour tone difference Naturally cured		Concrete	

**VERGE**

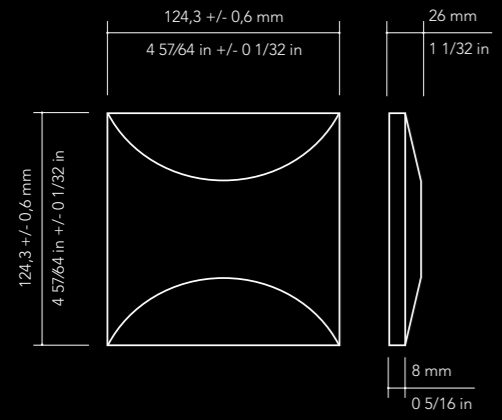

**BEFORE INSTALLING THE PRODUCT**

The surface where the product is being installed must be clean and level.

It is recommended that the layout of the product is prepared before the final installation.

Make sure you choose an adhesive apt for the area where the product is being installed.

**TO ENHANCE YOUR PRODUCT**

Use 1 mm - 0 3/64 in (0,5 mm - 0 1/64 in for CUE) spacers between the tiles to maintain an even installation over the whole surface. If the area where installing the material is not exposed

to humidity, grouting is optional, we recommend to use spacers of 0.5 mm without grout between the pieces. In item Nilo Porcelain It is recommended 2 mm (0 5/64 in) spacers between pieces.

The colour of the grout should be as close as possible to the colour of your product.

Once the area has been grouted, and before the grout dries, remove any excess material with a damp sponge.

To enhance the light and shadow effect, adequate vertical lighting over the product should be installed (ideally, above the highest point of the installation)

**MAINTENANCE**

Maintenance free. Easy and practical to care for, due to the high standard of technical characteristics in each ceramic product.

Avoid abrasive or acidic cleaning products.

For the Concrete items, it is recommended to clean with clear water.

**ANTES DE LA COLOCACIÓN**

Preparar la superficie sobre la que se va a colocar tu producto debe estar limpia y aplomada.

Se recomienda plantear la colocación, previo a su instalación.

Elegir el material de agarre en función de las características de la superficie.

**PARA ENSALZAR EL ASPECTO DE TU PRODUCTO**

Se recomiendan separadores de 1 mm (0,5 mm para el modelo CUE) para colocar las piezas y conseguir de esta forma un aspecto óptimo. Si la zona de colocación del material no va a estar expuesta a la humedad, se puede evitar el material de rejuntado, dejando solamente 0,5 mm de separación entre piezas.

En el modelo Nilo Porcelain se recomienda utilizar 2 mm de junta.

También es aconsejable que el color de rejuntado sea similar al color del producto elegido.

Una vez rejuntado el producto, y antes de que se endurezca, retirar el material sobrante de rejuntado con una esponja mojada en agua.

Para potenciar el pronunciado efecto de luz y sombra sobre cada pieza, es de vital importancia colocar luz cenital, situada verticalmente sobre el producto.

**MANTENIMIENTO**

Práctico y sencillo de limpiar, dadas las excelentes características técnicas del producto, tan sólo es necesario un cuidado rutinario, evitando la utilización de productos abrasivos o ácidos.

En el caso de los productos Concrete se recomienda limpiar exclusivamente con agua limpia.



---

## **WEBSITE LINKS**

[www.architecturalceramics.com/catalogs](http://www.architecturalceramics.com/catalogs)

PLEASE NOTE THIS LINK IS CASE SENSITIVE

## **CONTACT INFORMATION:**

[www.architecturalceramics.com](http://www.architecturalceramics.com)

1.800.287.1742

**For general sales inquiries:** [sales@architecturalceramics.com](mailto:sales@architecturalceramics.com)

**For commercial & hospitality sample requests:** [samples@architecturalceramics.com](mailto:samples@architecturalceramics.com)

**Headquarters:** 800 E Gude Dr Suite F Rockville, MD 20850