

- INSTRUCTION MANUAL -

APOLLO WALL SCONCE

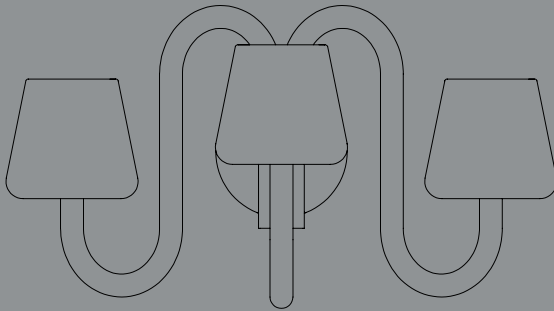

DESIGN BY STUDIO 0405

HAY

TECHNICAL DATA

This product is fitted with three G9 bulb fittings.
HAY recommends using this product with LED bulbs.

FITTING TYPE | 3 x G9 LED
POWER RANGE (W) | MAX 5W
SUGGESTED COLOUR TEMPERATURE | Warm white

HAY will not accept any responsibility for any accidents, injuries or damages that occur due to the use of incorrect bulbs.

ATTENTION

Ensure that the power supply to the circuit has clearly been turned OFF before installing the product. In some countries, electrical installation must be carried out by authorised electricians/contractors; please check with your local authority for guidance.

The product must not be modified in any way. HAY accepts no responsibility for any products that have been modified or tampered with. If the external flexible cable or cord of this luminaire is damaged, it should be exclusively replaced by a qualified electrician in order to avoid an electrical hazard. This lamp is designed for indoor use only.

CARE AND MAINTENANCE

The product can be cleaned with a soft damp cloth and mild detergent, or a dry microfibre cloth. Do not use alcohol or any other solvents to clean the product and avoid using abrasive or rough sponges. Ensure that the power supply has been turned OFF before cleaning the product.



- PARTS -

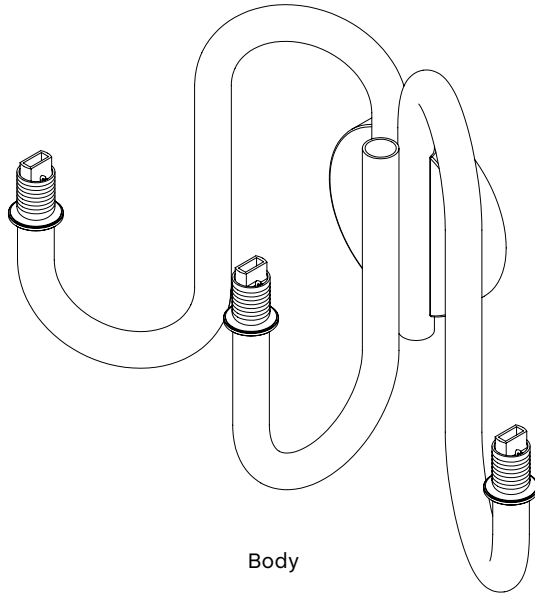

Body

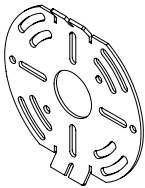

Universal mounting plate

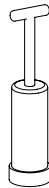

Shade ring tool



Glass shades



Shade ring



Set screw



M5 screws



Twist-on wire connectors
(US customers only)

1.

If you have an existing junction box in the wall, you can skip the next step. Use a pencil to mark fixing holes on either side of the cable exit hole in the wall. You can use the universal mounting plate as a guide, to mark the position of the holes on the wall. Drill the holes and insert the wall plugs. Ensure you use the correct type of wall plug for the material you are drilling into. For US customers - go to step 5.

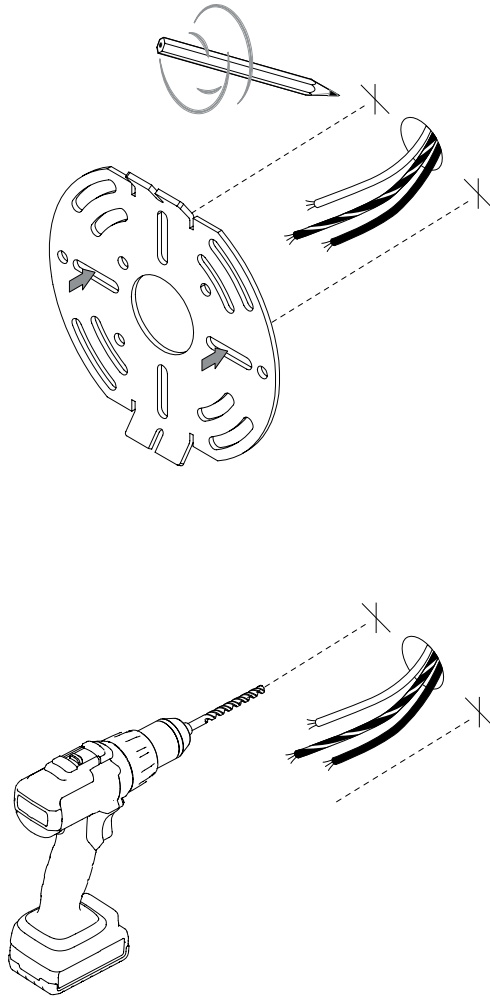

2.

Fix the universal mounting plate onto the wall using the provided screws.
Make sure it is positioned fully horizontally

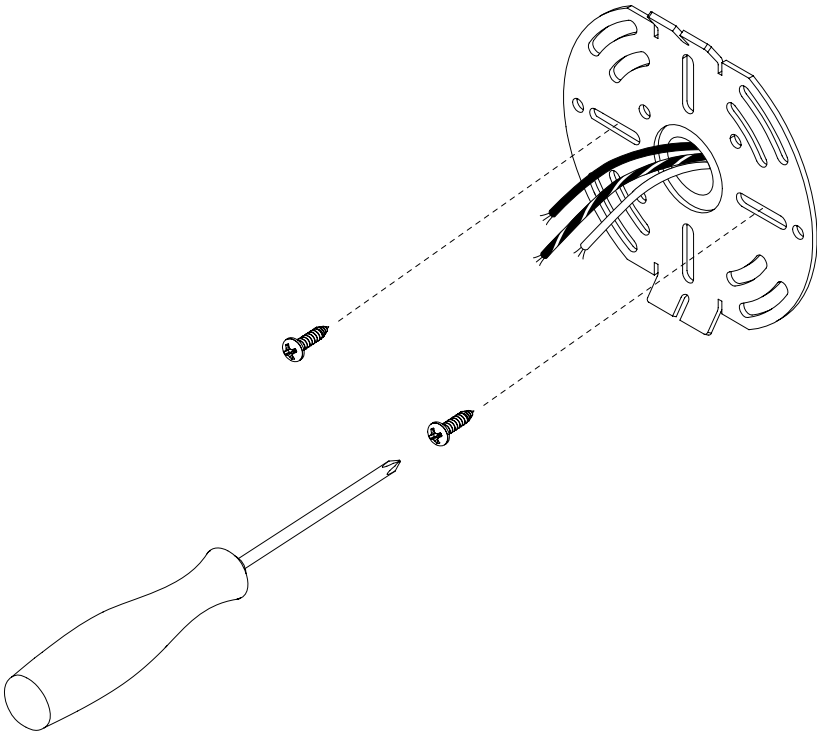

3.

Unscrew the set screw from underneath the lamp body.

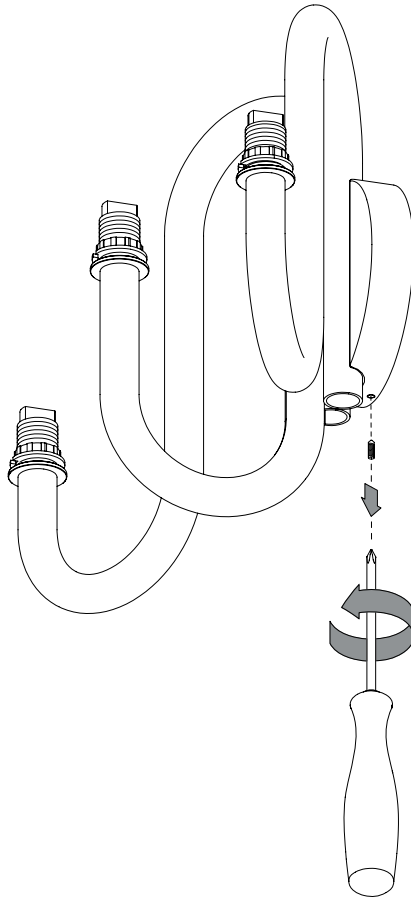

4.

Wire the wires from the wall to the terminal block on the back of the lamp. Ensure there is enough cable exposed to connect both positive and neutral connections into the terminal block. Use the integrated terminal block to connect the live and neutral wires. Both Live (L) and Neutral (N) are clearly marked on the terminal block. The Ground (⊕) connection is only to be used for connecting the source ground connection.

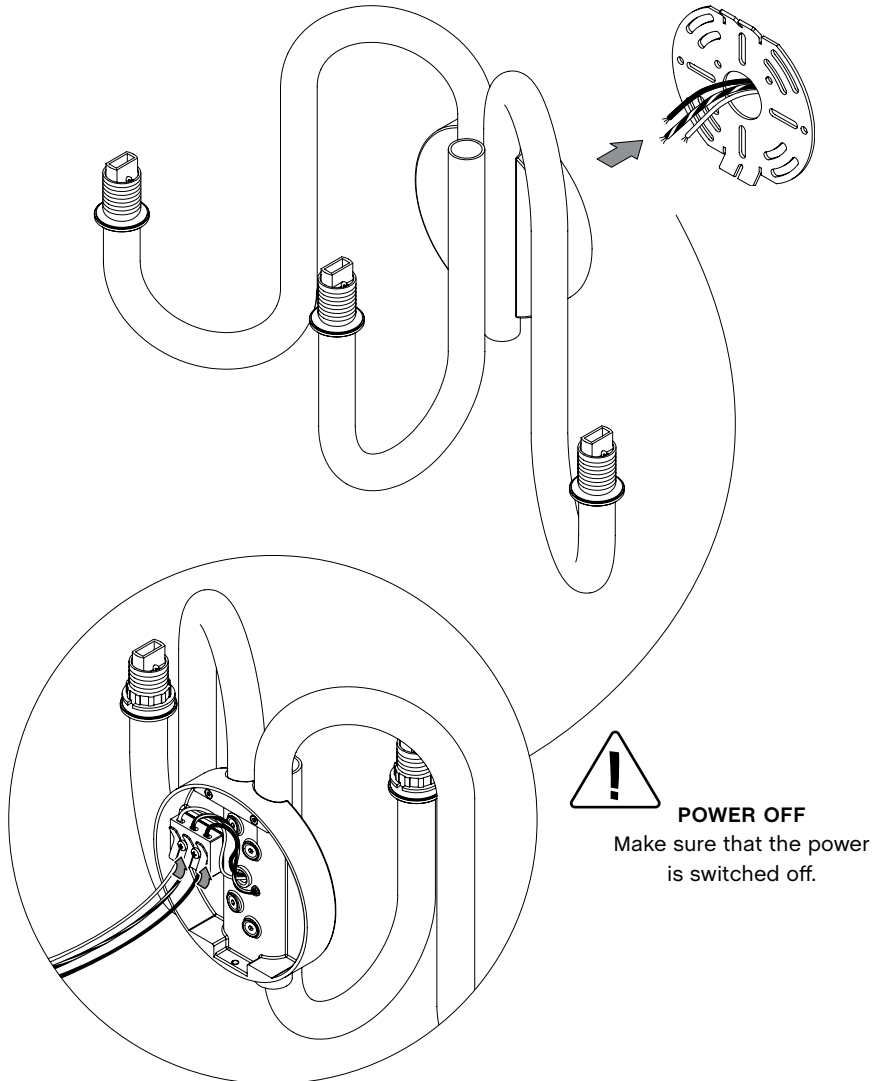

5.

For US customers only: Remove the twist-on wire connectors to disconnect the cable from the wires. Make the electrical connections between the main power line and the lamphouse with the twist-on wire connectors and gently tuck the wires into the junction box. Connect black to black / white to white. The Ground connection is only to be used for connecting the source ground connection. Attach the Mounting Plate onto the junction box, and select the proper screws for the type of junction box.
Continue from step 2 and skip step 4.

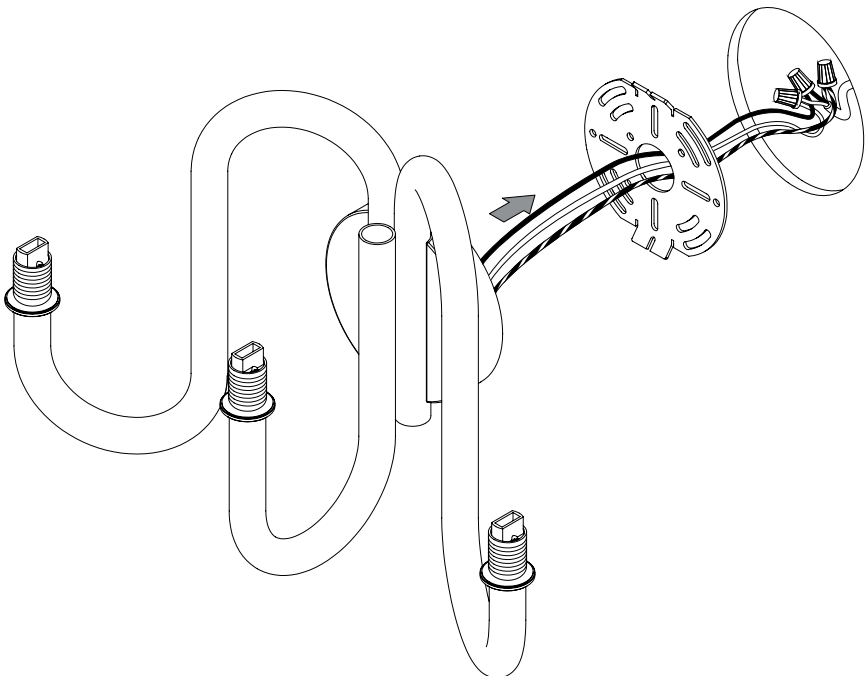
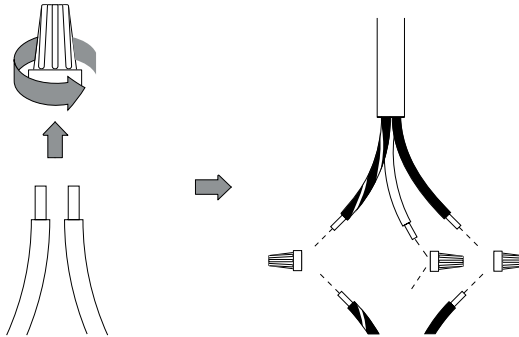

6.

Place the lamp over the universal mounting plate, ensuring it is properly positioned on the upper tab of the mounting bracket.

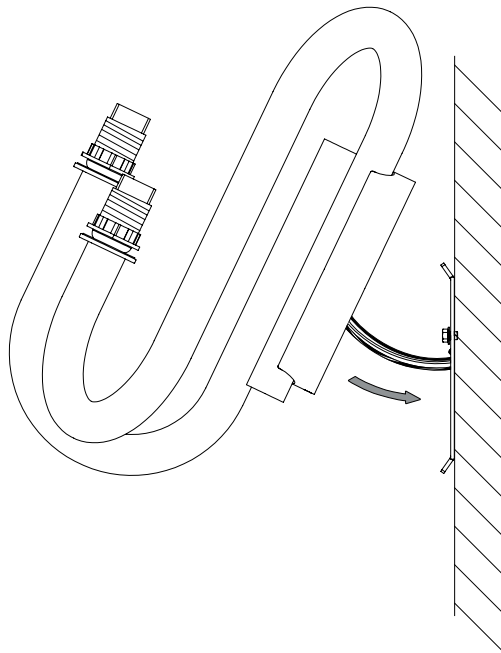

7.

Insert and tighten the set screw at the bottom of the lamp body to secure the lamp in place.

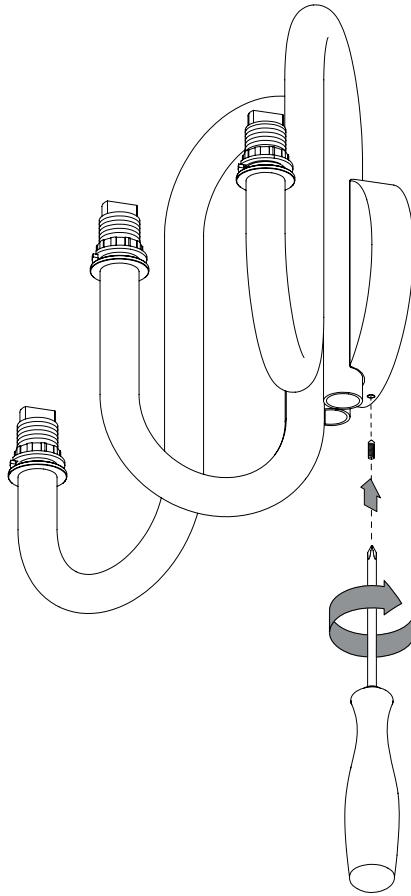

8.

Unscrew the shade rings by using the provided shade ring tool.

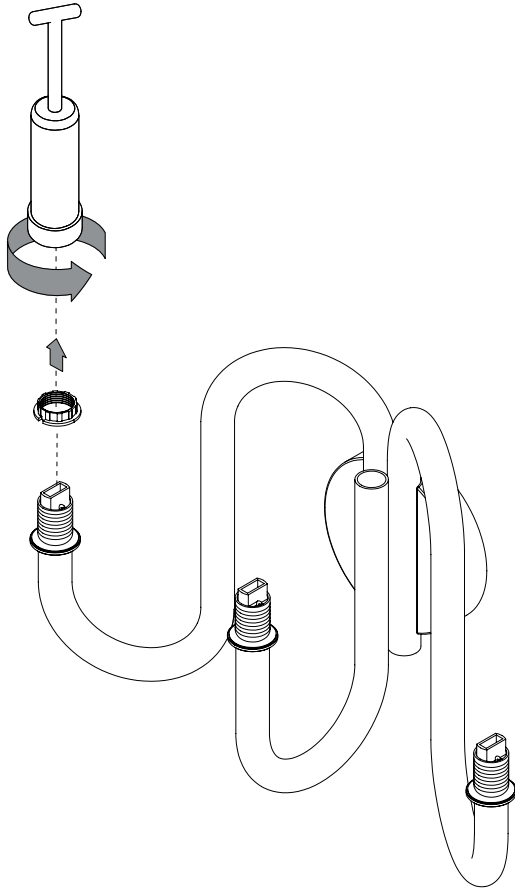

9.

Place the glass shades onto the arms.

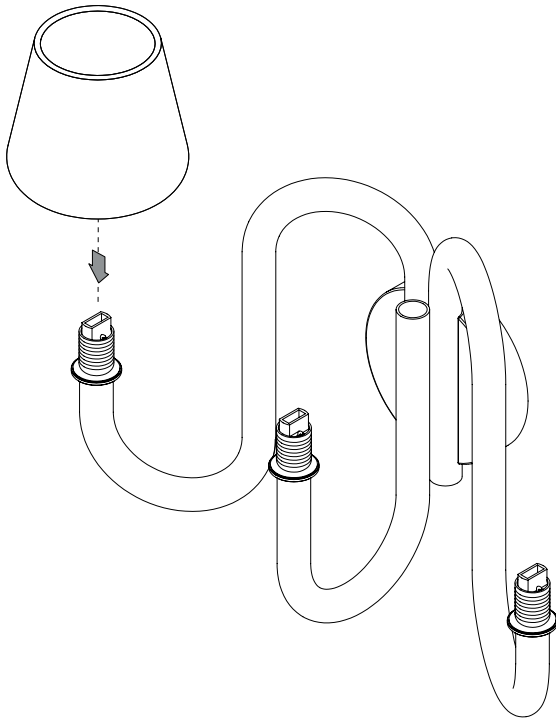

10.

Lock the shades in place with the shade rings.
Use the provided shade ring tool for easier assembly.

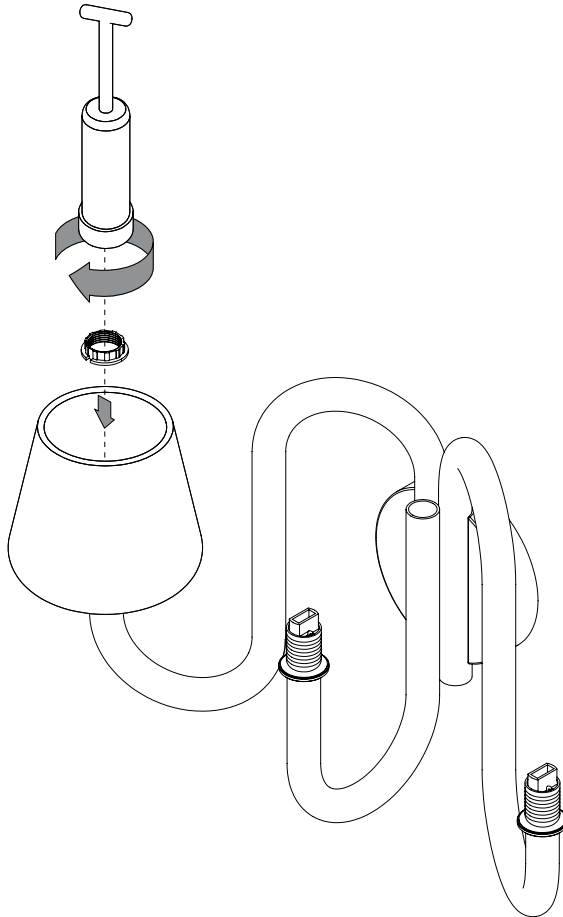

11.

Place three G9 bulbs into the bulb fittings.

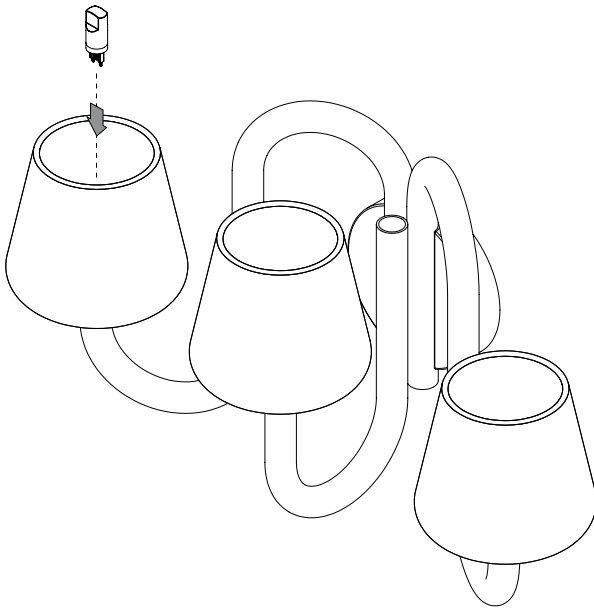

12.

The lamp is ready to use.

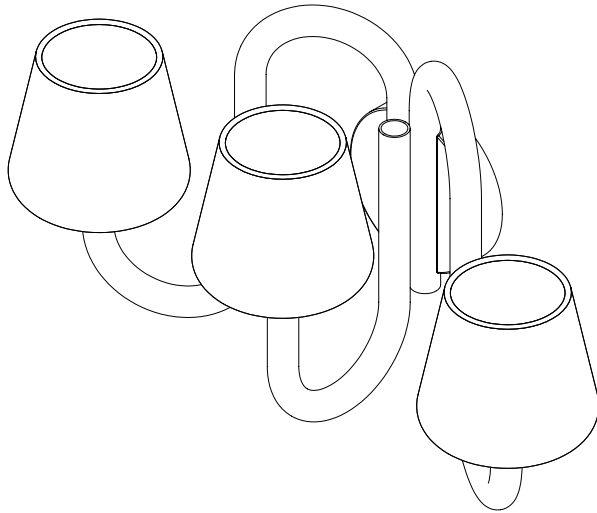

- CARE & MAINTENANCE -

Our Care & Maintenance offers guidance for optimal maintenance of your HAY product. It includes advice and instructions on cleaning and caring for specific materials to prolong the life of your lighting.



Please find our Care & Maintenance guide by scanning the QR code



You can find more relevant information on Apollo Wall Sconce by scanning the QR code

You can also find the same information here
hay.dk/downloads

Havnen 3 8700 Horsens Denmark
+45 3164 6000 / hay@hay.com

www.hay.com

22/03/2023

HAY