

GWENEN FLOOR LIGHT

Product Specification

Tom Raffield

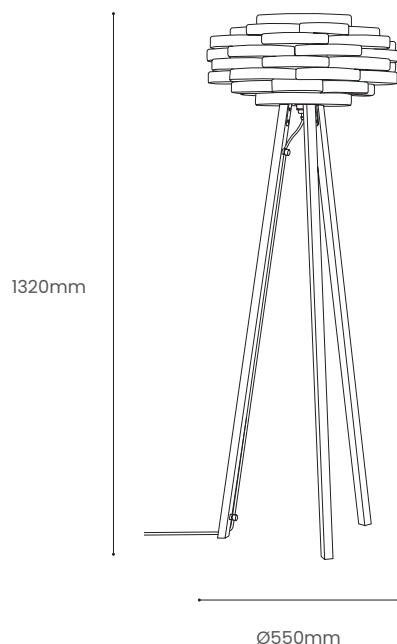





Gwenen Floor Light



A mesmerising fusion of craftsmanship and nature-inspired design, the Gwenen Lighting Range draws inspiration from the intricate layering found in the organic world, translated into a functional and exquisite wooden lighting centrepiece.

Meticulously crafted by hand, layered loops of sustainably sourced oak or walnut, weave together to produce this designer wooden floor light. Well suited for living spaces, cosy corners and bedrooms, the Gwenen Floor Light effortlessly becomes the focal point of any room. Even when switched off, its organic labyrinth of wooden curves creates an extraordinary spectacle to admire.

Enchant your home with organic opulence.

Product Type : Floor Light	SKU	Wood types	Dimensions L x W x H (mm)		Weight (kg)	
			Unboxed	Boxed	Unboxed	Boxed
Gwenen Floor Light	TR-GWEN-WDFLR-O	Oak	Shade 240 x Ø550	Shade -	Shade - 0.7 Stand - 1.95	Shade - Stand -
	TR-GWEN-WDFLR-W	Walnut	With Tripod: 1320mm height	Stand -		
Materials	Walnut 	Oak 	Other materials Brass Brackets  Birch ply frame 			
Finish	Wooden floor stand - Finished with a blend of natural wax oils to give a protective, hardwearing and beautiful finish. Shade - Non-toxic, hard wearing water based varnish - satin					
Wiring kit options	Brass bulb holder with black inline dimmer switch and plug 	Wiring kit	Flex	Recommended light bulb Max 25W LED		
		Plastic inline foot switch  E27 (240v)	Flex colour: grey fabric  Cable length: 240cm from switch to bulb holder. 115cm from switch to plug.			
Care information	Dusting your light regularly and with a light feather duster should keep your light looking clean, otherwise wipe with a damp cloth and remove any moisture with a dry cloth. Gentle furniture polishes can also be used.					
Additional information	<ul style="list-style-type: none"> Suitable for use on 240v circuits. This product can be plugged straight into a 240v outlet. Assembly instructions and fixings included. 					