

URCHIN SMALL – STEM FLOOR LIGHT

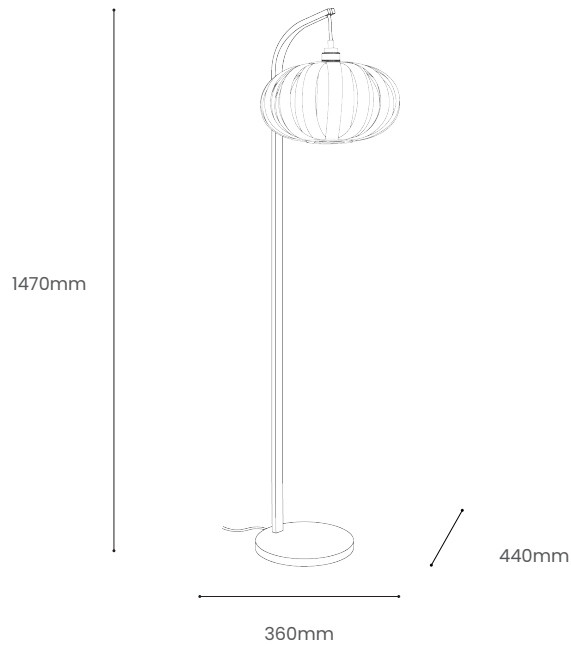





Tom Raffield

Product Specification

Urchin Small – Stem Floor Light



Handcrafted in sustainably sourced solid oak, the Stem's steam bent curve arches from its roots to showcase our coastal inspired Urchin Small lampshade, which creates unique slithers of light and shadow through its layered form. Use the wooden Urchin Small – Stem Floor Light to create ambience in your living space, dining room or accentuate your reading nook. Radiating light where you need it most; this statement wooden floor light is the ultimate balance between form and function.

Product Type : Floor Light	SKU	Wood types	Dimensions L x W x H (mm)		Weight (kg)	
			Unboxed	Boxed	Unboxed	Boxed
Urchin Small Stem Floor Light	TR-STM-FLR-URCN-O-SML	Oak	360 x 440 x 1470	Shade 470 x 465 x 325	2.75	Shade - 2.05 Stand - 7.8
				Stand 315 x 315 x 1550		
Materials	Oak 	Other materials				
		Brass Brackets 	Birch ply frame 			
Finish	Wooden floor stand - Finished with a blend of natural wax oils to give a protective, hardwearing and beautiful finish. Shade - Non-toxic, hard wearing water based varnish - satin					
Wiring kit options	Brass bulb holder with black inline dimmer switch and plug 	Wiring kit	Flex		Recommended light bulb	
		Plastic inline foot switch  E27 (240v)	Flex colour: grey fabric 			
			Cable length: 240cm from switch to bulb holder. 115cm from switch to plug.			Max 25W LED
Care information	Dusting your light regularly and with a light feather duster should keep your light looking clean, otherwise wipe with a damp cloth and remove any moisture with a dry cloth. Gentle furniture polishes can also be used.					
Additional information	<ul style="list-style-type: none"> Suitable for use on 240v circuits. This product can be plugged straight into a 240v outlet. Assembly instructions and fixings included. 					