

Hook rail  
Kroklist  
Hakenleiste  
ウォールフック

≡relief

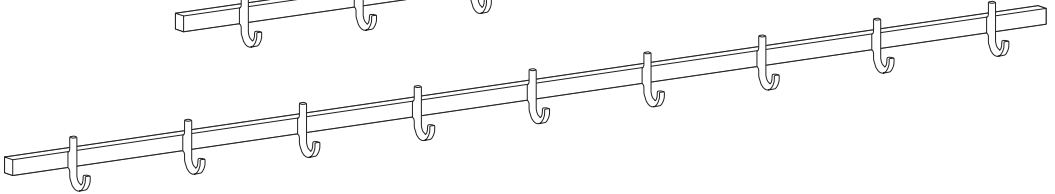
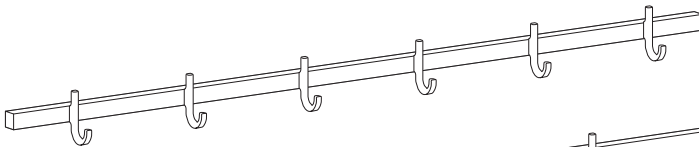
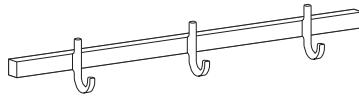

Scan QR code to watch or download assembly instructions.  
[stringfurniture.com](http://stringfurniture.com)

Option:

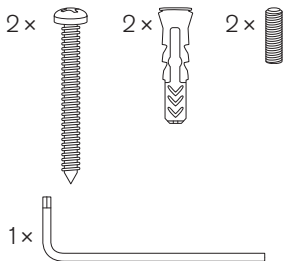

Option:

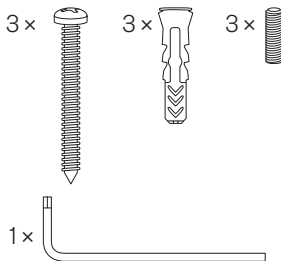

Option:

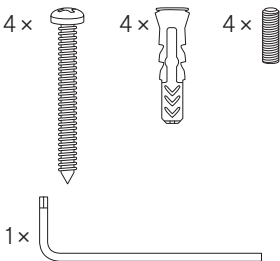

### Svenska

Detta är en produkt tillverkad av det svenska designföretaget String Furniture AB.

För kroklist rekommenderas max 2 kg last per krok.

### VARNING

Om kroklisten faller ner från väggen kan kläm-, sak- eller personsador uppstå. Undvik att kroklisten faller ner från väggen genom att säkerställa att kroklisten sitter ordentligt förankrad i väggen med hjälp av skruvar och/eller pluggar som lämpar sig för materialet i väggen. Följ dessutom monteringsanvisningen noga vid montering av kroklisten.

För råd om lämpliga skruvsystem kontakta din lokala fackhandlare.

### English

This is a product manufactured by the Swedish design company String Furniture AB.

For hook rail, we recommend max. 2 kg / 4 lbs. load per hook.

### CAUTION

If the hook rail falls down, crushing, damage to property or personal injury can occur. Avoid the hook rail from falling down by keeping the hook rail permanently fixed to the wall using screws and/or plugs designed for your wall material and follow the assembly instructions carefully when mounting the hook rail.

Get advice on suitable screw system from your local specialized dealer.

### Deutsch

Dieses Produkt ist von der schwedischen Designfirma String Furniture AB hergestellt.

Für die Hakenleiste wird eine Höchstlast von 2 kg pro Haken empfohlen.

### ACHTUNG

Wenn die Hakenleiste von der Wand fällt, kann es zu Quetschungen, Sachschäden oder Verletzungen kommen. Um zu verhindern, dass die Hakenleiste von der Wand fällt, stellen Sie sicher, dass die Hakenleiste ordnungsgemäß mit Schrauben und/oder Dübeln, die für die Wand geeignet sind, an der Wand verankert ist. Befolgen Sie außerdem bei der Montage der Hakenleiste sorgfältig die Montageanleitung.

Lassen Sie sich von Ihrem Fachhändler vor Ort über geeignete Schrauben und Dübel beraten.

### 日本語

これはスウェーデンのデザイン会社String Furniture ABが製造した製品です。

ウォールフックの耐荷重は、フック1つに対して2kgを推奨しています。

### 注意

ウォールフックが落下すると、収納物の落下や破損、大ケガや死亡事故に繋がる可能性があります。壁の材質に合ったネジやプラグを使用して、壁から外れないように永続的に固定してください。ウォールフックを取り付けるときは、説明書の手順に従ってください。詳しくは販売店、工務店やホームセンターにご確認ください。

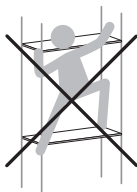

Do not use an electric screwdriver to assemble.  
電動ドライバーは使用しないでください。

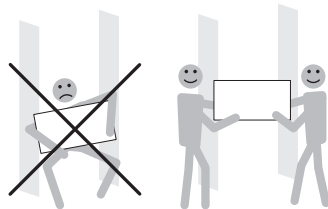

1 Option:

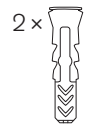
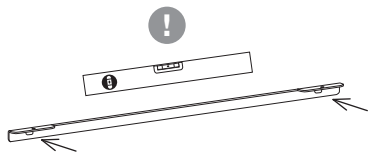

Option:

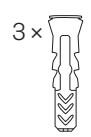
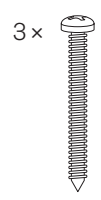
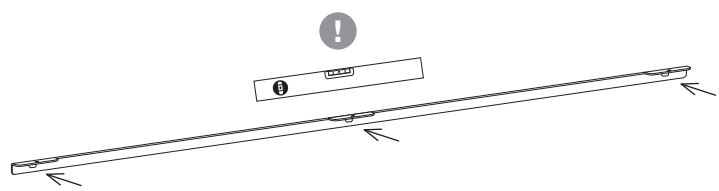

Option:

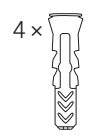
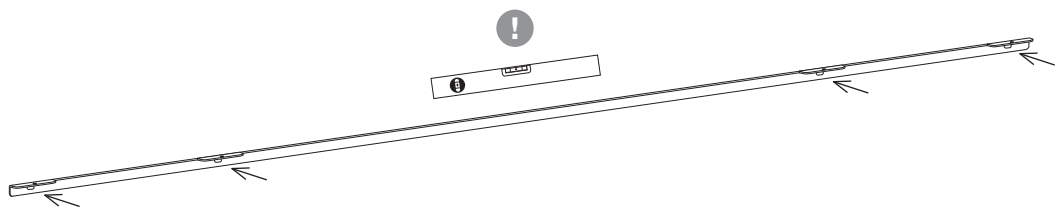

2

Option:



2x 

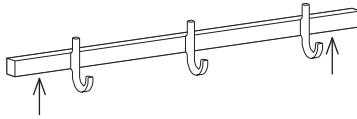

Option:



3x 

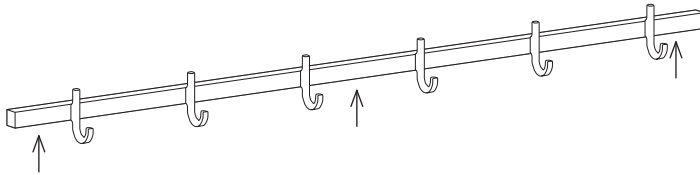

Option:



4x 

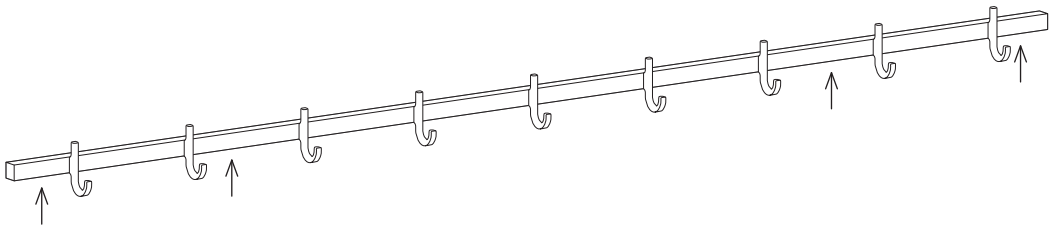

3

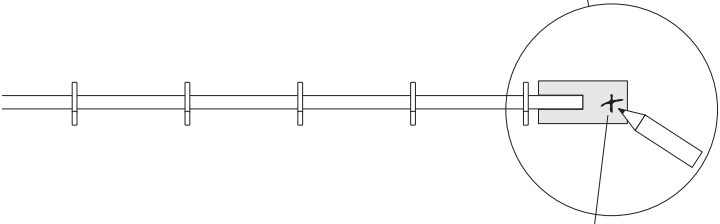
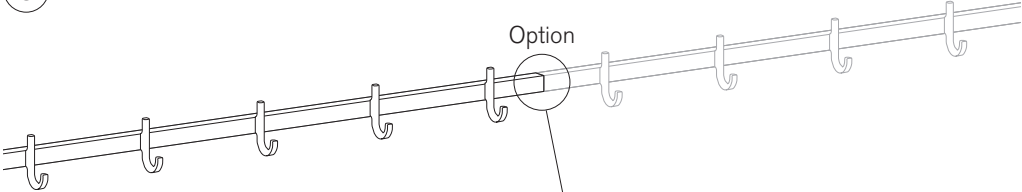

4

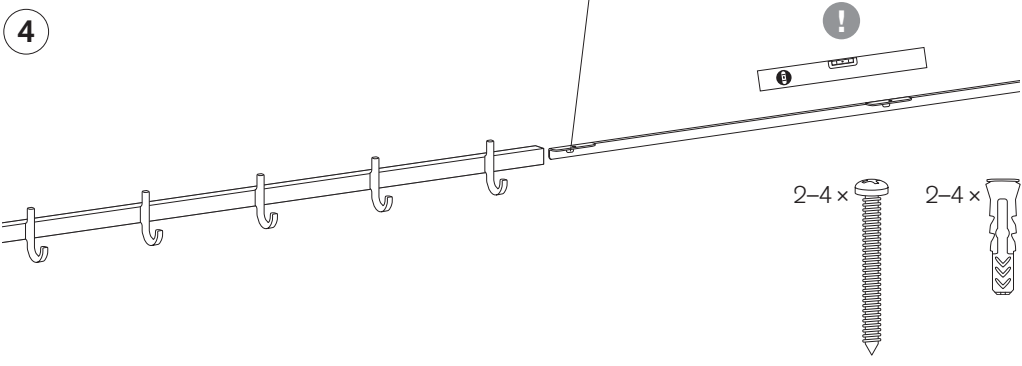

5

