

Class 150 Bronze Gate Valves

Union Bonnet • Non-Rising Stem • Solid Wedge

150 PSI/10.3 bar saturated steam to 366° F/185° C
300 PSI/20.7 bar non-shock cold working pressure

CONFORMS TO MSS SP-80

MATERIAL LIST

PART	SPECIFICATION
1. Handwheel Nut	300 Series Stainless Steel
2. Identification Plate	Aluminum
3. Handwheel	Malleable Iron ASTM A 47
4. Stem	Silicon Bronze ASTM B 371 Alloy C69400/C69430 or ASTM B 99 Alloy C65100
5. Packing Nut	Bronze ASTM B 62 or ASTM B584 Alloy C84400 or Brass ASTM B 16
6. Packing Gland	Bronze ASTM B 62 or ASTM B584 Brass ASTM B16 C36000
7. Packing	Aramid Fibers with Graphite
8. Stuffing Box	Bronze ASTM B 62
9. Bonnet	Bronze ASTM B 62
10. Union Nut	Bronze ASTM B 62
11. Body	Bronze ASTM B 62
12. Wedge	Bronze ASTM B 62
13. Wedge Holder	Bronze ASTM B 62 (Not shown)



T-136
Threaded



S-136
Solder

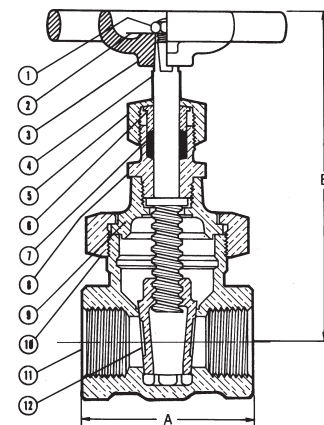

T-136
NPT x NPT

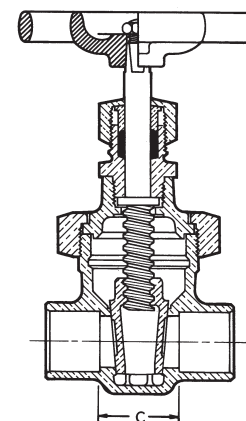

S-136
C x C

DIMENSIONS—WEIGHTS—QUANTITIES

Size	Dimensions						T-136		S-136		Master Ctn. Qty.	
	A		B		C		Lbs.	Kg.	Lbs.	Kg.		
In.	mm.	In.	mm.	In.	mm.	In.	mm.					
¼	8	1.96	50	3.63	92	x	x	1.09	0.50	x	x	50
⅜	10	1.96	50	3.63	92	0.79	20	1.07	0.48	1.02	0.46	50
½	15	2.31	59	3.63	92	0.76	19	1.12	0.51	1.02	0.46	40
¾	20	2.51	64	3.91	99	0.98	25	1.63	0.74	1.47	0.67	30
1	25	2.92	74	4.69	119	1.13	29	2.26	1.03	2.15	0.98	20
1¼	32	3.20	81	5.22	133	1.18	30	3.52	1.60	3.35	1.52	10
1½	40	3.33	86	6.25	159	1.29	34	4.44	2.01	4.22	1.92	10
2	50	3.44	87	7.06	179	1.31	33	7.35	3.34	6.72	3.05	6
±2½	65	4.35	110	8.41	224	1.81	46	11.80	5.36	11.40	5.17	4
±3	80	5.31	135	10.00	254	1.97	50	17.41	7.90	15.80	7.17	2

± Split Wedge with wedge holder.

x Not available this size.

FREEZING WEATHER PRECAUTION: Subsequent to testing a piping system, valves should be left in an open position to allow complete drainage.

◆ For detailed Operating Pressure, refer to Pressure Temperature Chart on page 114.



WARNING: This product can expose you to chemicals including lead, which is known to the State of California to cause cancer and birth defects or other reproductive harm. For more information go to www.P65Warnings.ca.gov.

Visit our website for the most current information.