

**Plan Column Table**

By Edward Barber & Jay Osgerby, 2023

<b>Model</b>	6627 - Column Ø72 cm
<b>About</b>	The Plan Column Table is a versatile and simple table designed for smaller spaces or specific needs, making it ideal as a dining table, for cafes, or as an intimate meeting table.
<b>Product group</b>	Tables
<b>Measurements</b>	28.35" Diam. x 25.59" H   28.74" H   37.4" H   41.34" H
<b>Weight</b>	45 kg

**Materials** Column table. Frame in powder coated steel and aluminum. Table top in stone with a full rounded edge profile and solid wood or laminate with a straight edge. Delivered with felt glides. Available in different heights.

**Guarantee** Fredericia Furniture A/S offers a 7 year guarantee against manufacturing defects in standard products (materials and construction). Wear and damage to covers, surface treatment, inappropriate use and the like are not covered by the warranty.

**Download** [Click here to download images, architect files at our partner portal.](#)



**DRAWING**

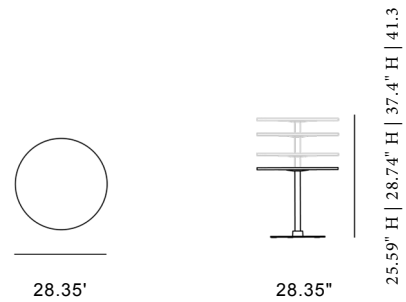

**FRAME**



BLACK PAINTED



BORDEAUX



MODERNIST GREEN

**TABLE TOPS**



BLACK LAMINATE

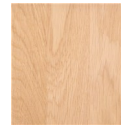

OAK LIGHT OIL, FSC MIX 70%



SMOKED OAK, OILED, FSC MIX 70%

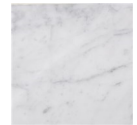

WHITE CARRARA