



6 QT AIR FRYER WITH TOUCHSCREEN

Instruction Manual



Thank You for your purchase

Register & sign up for special
announcements and trendy recipes!

Tell us what you think!
Rate, review or ask us a question.

@bellahousewares.com
#getinspired



BellaLife



BellaLifestyle

Table of Contents

Important Safeguards	2-3
Additional Important Safeguards	4-5
Notes on the Plug	5
Notes on the Cord.....	6
Plasticizer Warning	6
Electric Power.....	6
Getting to Know Your 6QT Air Fryer	7
Touchscreen Control	8-9
Before Using for the First Time	9-10
Operating Instructions	10
Manual Operation.....	11
6 Function Menu Presets (Air Fry Roast Broil Bake Reheat French Fries).....	12
Air Fry / Roast Cooking Chart	12-15
User Maintenance Instructions.....	16
Care & Cleaning Instructions	16
Storing Instructions.....	16
Troubleshooting.....	17-18
Recipes.....	19-27
Warranty	28-29

IMPORTANT SAFEGUARDS

When using electrical appliances, basic safety precautions should always be followed including the following:

- 1. READ ALL INSTRUCTIONS.**
2. Do not touch hot surfaces. Use handles or knobs. Use oven mitts or potholders.
3. To protect against electric shock do not immerse cord, plugs, or appliance in water or other liquid.
4. This appliance is not intended for use by persons (including children) with reduced physical, sensory or mental capabilities, or lack of experience and knowledge, unless they have been given supervision or instruction concerning use of the appliance by a person responsible for their safety.
5. Children should be supervised to ensure that they do not play with the appliance.
6. Unplug from outlet when not in use and before cleaning. Allow to cool before putting on or taking off parts, and before cleaning the appliance.
7. Do not operate any appliance with a damaged cord or plug or after the appliance malfunctions, or has been damaged in any manner. Bring it to a qualified technician for examination, repair or electrical or mechanical adjustment.
8. The use of accessory attachments not recommended by the appliance manufacturer may cause injuries.
9. Do not use outdoors.
10. Do not let cord hang over edge of table or counter, or touch hot surfaces.

11. Do not place on or near a hot gas or electric burner, or in a heated oven.
12. Extreme caution must be used when moving an appliance containing hot oil or other hot liquids.
13. Always attach plug to appliance first, then plug cord into the wall outlet. To disconnect, turn any control to “off”, then remove plug from wall outlet.
14. Do not use appliance for other than intended use.
15. Make sure the crisping tray is in place before adding food to be air fried.
16. Make sure the frying basket is locked securely into the front of the Air Fryer, while the Air Fryer is in operation.

WARNING: The Air Fryer will not operate unless frying basket is fully closed.

CAUTION: After hot air frying, extreme caution must be used when handling the hot frying basket, crisping tray, and cooked foods.

FOR HOUSEHOLD USE ONLY

SAVE THESE INSTRUCTIONS

ADDITIONAL IMPORTANT SAFEGUARDS

CAUTION HOT SURFACES: This appliance generates heat and escaping steam during use. Proper precautions must be taken to prevent the risk of burns, fires, or other injury to persons or damage to property.

CAUTION: This appliance is hot during operation and retains heat for some time after turning OFF. Always use oven mitts when handling hot materials and allow metal parts to cool before cleaning. Do not place anything on top of the appliance while it is operating or while it is hot.

1. All users of this appliance must read and understand this instruction manual before operating or cleaning this appliance.
2. The cord to this appliance should be plugged into a 120V AC electrical outlet only.
3. If this appliance begins to malfunction during use, pull the frying basket drawer out of the body. Then remove plug from wall outlet. Do not use or attempt to repair the malfunctioning appliance.
4. Do not leave this appliance unattended during use.
5. Do not immerse power cord in any liquid. If the power cord to this appliance is damaged, it must be replaced by contacting Consumer Service.
6. Keep the cord out of reach from children and infants to avoid the risk of electric shock and choking.
7. Place the Air Fryer on a flat, heat-resistant work area.

8. Do not obstruct the air outlet or air inlets on the back and sides of the Air Fryer, with any objects. Avoid escaping steam from the air outlet during air frying.
9. Keep appliance at least 4 inches away from walls or other objects during operation.
10. Always use the frying basket handle to open frying basket drawer.
11. **WARNING:** After air frying, make sure to place the frying basket drawer on a flat, heat-resistant surface.
WARNING: Over-filling the frying basket may damage the Air Fryer and could result in serious personal injury.
12. Never move a hot Air Fryer or an Air Fryer containing hot food. Allow to cool before moving.
13. Do not clean with metal scouring pads. Pieces can break off the pad and touch electrical parts, creating a risk of electric shock.

NOTES ON THE PLUG

This appliance has a polarized plug (one blade is wider than the other).

To reduce the risk of electric shock, this plug will fit in a polarized outlet only one way. If the plug does not fit fully into the outlet, reverse the plug. If it still does not fit, contact a qualified electrician. Do not modify the plug in any way

NOTES ON THE CORD

- A. A short power-supply cord (or detachable power-supply cord) is to be provided to reduce the risk resulting from becoming entangled in or tripping over a longer cord.
- B. Longer detachable power-supply cords or extension cords are available and may be used if care is exercised in their use.
- C. If a long detachable power-supply cord or extension cord is used :
 - 1. The marked electrical rating of the cord or extension cord should be at least as great as the electrical rating of the appliance;
 - 2. If the appliance is of the grounded type, the extension cord should be a grounding-type 3-wire cord.
 - 3. The longer cord should be arranged so that it does not drape over the countertop or table top where it can be pulled on by children or tripped over unintentionally.

PLASTICIZER WARNING

CAUTION: To prevent Plasticizers from migrating to the finish of the counter top or table top or other furniture, place **NON-PLASTIC** coasters or place mats between the appliance and the finish of the counter top or table top. Failure to do so may cause the finish to darken; permanent blemishes may occur or stains can appear.

ELECTRIC POWER

If the electrical circuit is overloaded with other appliances, your appliance may not operate properly. It should be operated on a separate electrical circuit from other appliances.

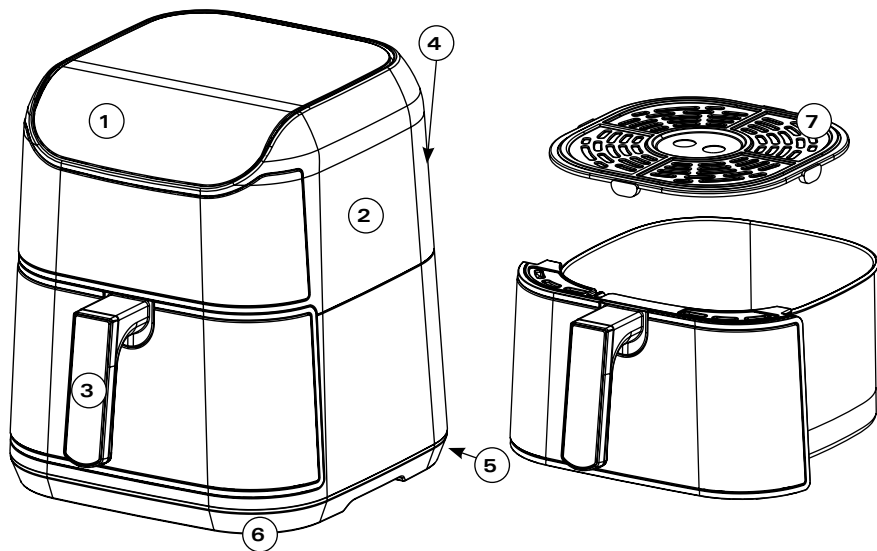



Getting to Know Your 6QT Air Fryer

Product may vary slightly from illustration

1. Touchscreen Control
2. Air Fryer Body
3. Frying Basket with Cool Touch Handle
4. Air Outlets (not shown)
5. Power Cord with Polarized Plug (Not Shown)
6. Non Skid Feet
7. Non Stick Cooking Tray

Touchscreen Control



1. Plug cord in the wall outlet, the white START/PAUSE  button will start flashing.
2. Press the START/PAUSE button. The control panel will illuminate.
3. Press the MENU  button and select the desired preset option.
4. Once the selected preset option illuminates, press the START/PAUSE  button to start cooking.

Timer Control Buttons

- Selecting the timer control , add or decrease cooking time using the + and - symbols. This enables you to add or decrease cooking time, one minute at a time. Keeping the button held down will rapidly change the time.

Temperature Control Buttons

- Selecting the temperature control , add or decrease temperature using the + and - symbols.
- This enables you to add or decrease cooking temperature 10°F at a time. Keeping the button held down will rapidly change the temperature. Temperature control range: 170°F – 400°F.

MENU Preset Choices

- 6 presets to choose from: Air Fry, Roast, Broil, Bake, Reheat and French Fries.

Adjustable Control (Temperature and Timer)

- The + and - symbols enable you to add or decrease cooking temperature and time.

FUNCTIONS	TIME (MIN)		TEMP(°F)	
	DEFAULT	RANGE	DEFAULT	RANGE
Air Fry	20 mins	1-60 mins	400 °F	170-400 °F
Roast	35 mins	1-60 mins	400 °F	350-400 °F
Broil	10 mins	1-30 mins	400 °F	/
Bake	25 mins	1-60 mins	350 °F	170-400 °F
Reheat	6 mins	1-60 mins	250 °F	170-400 °F
French Fries	18 mins	1-60 mins	360 °F	170-400 °F

IMPORTANT! Depending on the thickness and/or density of foods, it may be necessary to use a meat thermometer to check cooking progress after preset TIME has expired. If more time is needed, cook at short time intervals until food tests done.

Before Using for the First Time

1. Remove all packing material and labels from the inside and outside of the Air Fryer. Check that there is no packaging underneath and around the frying basket.
2. Your Air Fryer is shipped with the frying basket locked inside the Air Fryer body. Firmly grasp the frying basket handle to open frying basket and place on a flat, clean work area.
3. Wash frying basket and crisping tray in hot, soapy water.
4. **DO NOT IMMERSE THE AIR FRYER BODY IN WATER.**

Wipe the Air Fryer body with a damp cloth. Dry all parts thoroughly.

- To ensure the crisping tray fits snugly into the frying basket drawer, there are 4 rubber tips attached to the sides of the tray. Before using, check to make sure all 4 rubber tips are in place. If they become separated from the tray, simply slide onto the tabs as shown. (See fig 2.)

NOTE: During first use, the Air Fryer may emit a slight odor. This is normal and will not affect the flavor or air frying.

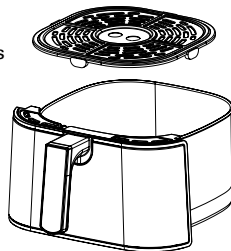

Figure 2



Operating Instructions

WARNING! This Air Fryer should not be used to boil water.

WARNING! This Air Fryer should never be used to deep fry foods.

- Place the Air Fryer on a flat, heat-resistant work area, close to an electrical outlet.
- Firmly grasp the frying basket handle to open frying basket; then remove from the machine and place on a flat, clean surface.
- Place the crisping tray into the base of the frying basket.
- Insert the assembled frying basket drawer into the front of the Air Fryer. Always make sure frying basket drawer is fully closed.
- Plug cord in the wall outlet. An audible beep will sound and a white START/PAUSE  button will appear on a black background. Press the START/PAUSE button. The control panel will illuminate.
- Press the MENU button and select the desired preset option.
- Once the selected preset option illuminates, press the START/PAUSE  button to start cooking.

IMPORTANT: If no buttons are pressed, the Digital Air Fryer will remain in standby mode for 5 minutes.

Manual Operation

1. To adjust the default air frying TIME, select timer control button , press the + or - on the control panel to advance or decrease TIME in 1 minute increments, from 1 to 60 minutes.

NOTE: Timer can also be adjusted when time reflects on the digital display.

2. To adjust the default air frying Temperature, select temperature control button , press the + or - on the control panel to adjust the default (400°F) TEMP from 170°F to 400°F in 10°F increments.

NOTE: Temperature can also be adjusted when temperature reflects on the digital display using.

3. When the desired TIME and TEMP appear on the digital display, press the START/PAUSE  button to turn the Air Fryer ON. The preset TIME will begin to count down. TEMP and remaining TIME will appear on the digital display.

IMPORTANT: If no buttons are pressed, the Digital Air Fryer will remain in standby mode for 5 minutes.

4. To turn the Air Fryer OFF at any time, or to reset the TIME, simply press and hold the white START/PAUSE  button.

NOTE: To halt air frying immediately, pull the frying basket drawer out of the body at any time. When the drawer is replaced, air frying will resume.

5. When the remaining TIME reaches 00:00, the display will show “END” and 5 beeps will sound as the Air Fryer automatically stop heating, the fan will keep working for 1 min till the unit turns OFF.

6 FUNCTION MENU PRESETS (Air Fry | Roast | Broil | Bake | Reheat | French Fries)

1. To use food MENU options, simply press the desired function icon
2. When the desired function menu option icon is flash, press the START/PAUSE  button to turn the Air Fryer ON.

NOTE: The quantity, density, weight of food will alter the total cooking time necessary.

Remember, frying smaller batches will result in shorter cooking times and higher food quality.

IMPORTANT: Always check food halfway through cooking time to determine final cook TIME and TEMP.

3. To adjust the air frying TIME during operation, press TIME button then + or - on the right side of the control panel to advance or decrease time in 1 minute increments to 60 minutes.

Press the TEMP button then + or - on the right side of the control panel to adjust TEMP in 10°F increments.

Air Fry / Roast Cooking Chart

Times are estimated and based on average sizes and weights.

ALWAYS USE A MEAT THERMOMETER TO ENSURE THAT MEAT, POULTRY AND FISH ARE COOKED THOROUGHLY BEFORE SERVING.

NOTE: Frying smaller batches will result in shorter cooking times and higher food quality. Adjust air frying TEMP and TIME as necessary to suit your taste.

NOTE: Unless food is pre-packaged and pre-oiled, for browned and crispy results, all foods should be lightly oiled before air frying.

Air Fry / Roast Cooking Chart

FOOD	TEMP	AIR FRY	ROAST	AIR FRY/ROAST TIME
VEGETABLES				
Asparagus	400 °F	X	X	5 - 7 minutes
Broccoli Florets (roasted)	400 °F		X	6 - 10 minutes
Brussels Sprouts	380 °F	X	X	12 - 15 minutes
Cauliflower Florets (roasted)	400 °F		X	6 - 10 minutes
Corn on the Cob	390 °F	X	X	6 - 8 minutes
Eggplant, 1-1/2-inch cubes (roasted)	400 °F	X	X	15 minutes
Fennel, fresh, chopped	380 °F	X	X	10 - 13 minutes
French Fries, (fresh, soaked, 1/4 to 1/3-in. thick)	400 °F	X		16 - 20 minutes
Mushrooms, sliced	400 °F	X	X	5 minutes
Peppers, bell, 1-inch chunks	380 °F	X	X	10 minutes
Peppers, jalapeno, poblano (roasted)	380 °F		X	10 minutes
Potatoes, 1-inch cubes	400 °F	X		12 - 14 minutes
Potatoes, whole	400 °F	X	X	40 minutes
Root Vegetables, 1/2-in. chunks (roasted)	400 °F		X	15 - 20 minutes
Sweet Potatoes, whole	380 °F	X	X	30 - 35 minutes
Zucchini, 1/4-inch discs	400 °F	X	X	12 - 17 minutes

Air Fry / Roast Cooking Chart

FOOD	TEMP	AIR FRY	ROAST	AIR FRY/ROAST TIME
BEEF				
Hamburgers, 1/4 lb. (up to 4)	360 °F		X	12 – 16 minutes
Hot Dogs /Sausages	360 °F		X	10 – 15 minutes
Meatloaf, 1 lb.	360 °F		X	35 – 40 minutes
Steak	360 °F		X	8 – 12 minutes
Beef Tenderloin, 1 lb., rare	360 °F		X	16 minutes
Beef Tenderloin, 1 lb., medium	360 °F		X	18 minutes
CHICKEN				
Chicken Breast, boneless, skinless	360 °F	X	X	10 – 15 minutes
Chicken Pieces	360 °F	X	X	20 - 30 minutes
Chicken Tenders/Fingers, battered	360 °F	X	X	13 - 15 minutes
Chicken Wings	360 °F	X	X	20 minutes
PORK AND LAMB				
Bacon, thick cut	400 °F		X	8 – 10 minutes
Ham, precooked, boneless, 3 lb.	300 °F		X	1 hour
Lamb Loin Chops, 1-inch thick	400 °F		X	8 – 12 minutes
Pork Chops, 1-inch thick	380 °F		X	10 – 14 minutes

Air Fry / Roast Cooking Chart

FOOD	TEMP	AIR FRY	ROAST	AIR FRY/ROAST TIME
FISH AND SEAFOOD				
Catfish Fingers (thawed, battered)	400 °F	X		10 - 15 minutes
Shrimp (thawed, battered)	320 °F	X		12 minutes
Shrimp (thawed, sauced)	320 °F	X		5 - 8 minutes
Frozen Foods				
Cheese Sticks (frozen)	350 °F	X		6 – 9 minutes
Chicken Nuggets (frozen)	360 °F	X		10 - 15 minutes
Fish Sticks (frozen)	400 °F	X		12 – 18 minutes
French Fries, thick (frozen) 4 cups	400 °F	X		17 – 21 minutes
French Fries, thin (frozen) 4 cups	400 °F	X		15 – 17 minutes
Meatballs, 1-inch	380 °F	X		7 - 9 minutes
Onion Rings (frozen)	360 °F	X		12 – 16 minutes
Pizza, frozen, 7-in. x 8-in.	360 °F	X		12 - 15 minutes
DESSERTS				
Apple Turnovers	400 °F	X		10 minutes
Cake	350 °F	X		25 minutes

User Maintenance Instructions

This appliance requires little maintenance. It contains no user-serviceable parts.

Any servicing requiring disassembly other than cleaning must be performed by a qualified appliance repair technician.

Care & Cleaning Instructions

WARNING! Allow the Air Fryer to cool fully before cleaning.

1. Unplug the Air Fryer. Remove frying basket. Make sure the frying basket and crisping tray have cooled completely before cleaning. Use the center hole of the crisping tray to lift crisping tray up and out of the frying basket.
2. Wash the frying basket and crisping tray in hot soapy water. Do not use metal kitchen utensils or abrasive cleansers or cleaning products as this may damage the nonstick coating.
3. The frying basket and crisping tray are dishwasher-safe. For best results, place in the top rack of your dishwasher to clean.
4. Wipe the Air Fryer body with a soft, non-abrasive damp cloth to clean.

Storing Instructions

1. Make sure the Air Fryer is unplugged and all parts are clean and dry before storing.
2. Never store the Air Fryer while it is hot or wet.
3. Lock the frying basket into the drawer, and store inside the Air Fryer body.
4. Store Air Fryer in its box or in a clean, dry place.



Troubleshooting

PROBLEM	POSSIBLE CAUSE	SOLUTION
The AIR FRYER does not work	<ul style="list-style-type: none"> The Air Fryer is not plugged in. The Air Fryer has turned itself OFF 	<ul style="list-style-type: none"> Plug cord into the wall outlet. To begin, press the white START/PAUSE  button. Make sure the frying basket/drawer is assembled correctly and fully inserted into the Air Fryer body.
Food not cooked	<ul style="list-style-type: none"> The Frying Basket is overloaded. 	<ul style="list-style-type: none"> Fry smaller batches of food. Shake foods 2x or 3x during the cooking process. Increase TEMP. Increase air fry TIME.
Food is not fried evenly	<ul style="list-style-type: none"> The Frying Basket is overloaded. 	<ul style="list-style-type: none"> Fry smaller batches of food. • Apply a light, even coat of spray oil to food before frying Shake foods 2x or 3x during the cooking process. Fry smaller batches of food.
Frying basket/drawer won't slide into the Air Fryer body properly	<ul style="list-style-type: none"> The Frying Basket is overloaded. 	<ul style="list-style-type: none"> Fry smaller batches of food. Air Fryer will not turn ON until the frying basket/drawer is assembled correctly and fully inserted into the Fryer body

PROBLEM	POSSIBLE CAUSE	SOLUTION
White smoke coming from the Air Fryer	<ul style="list-style-type: none"> • The Frying Basket is overloaded 	<ul style="list-style-type: none"> • Soak, rinse and fully dry potatoes before frying. • Use fresh, firm potatoes.
Fresh fries are not fried evenly Fries are not crispy	<ul style="list-style-type: none"> • Raw fries have too much water. 	<ul style="list-style-type: none"> • Use a clean kitchen towel to wrap and dry potato sticks thoroughly before adding oil. • Cut potato sticks smaller. • Shake and spray potatoes frequently

Recipes

Seasoned Kale Chips

- 6 cups raw kale, dry, cleaned, stemmed, cut into 1 to 2-inch ribbons, spray with olive oil
 - 1 teaspoon garlic powder
 - 3/4 teaspoon chili powder
 - 1/2 teaspoon onion powder
 - 1/2 teaspoon smoked paprika
 - 1/4 teaspoon fine grain sea salt or pink Himalayan sea salt
 - 1/8 teaspoon cayenne pepper (optional)
1. Combine seasoning ingredients in a small bowl. Stir to combine.
 2. Add 3 cups raw kale to the air frying basket. Spray with olive oil. Add half of the seasoning mixture to the oiled kale. Toss to coat.
 3. Press  until AIR FRY appears and set at 370 °F for 3 minutes. Press the START/PAUSE  to begin operation. Shake at 2 minutes.
 4. Empty first batch into a large serving bowl. Oil, season and air fry the second batch and add to the bowl to serve.

Recipes

Spicy Adobo Drumsticks 2 Ways: Roasted / Air Fried

Makes: 4-5 chicken drumsticks

Serves 4 to 6

Brine

- 6 cups water
- 1/4 cup sugar
- 1/2 cup Kosher salt

Rub

- 4 tablespoons Adobo
- 1 tablespoon paprika
- 1 tablespoon Chile de Arbol, ground (to taste)



Breading

- 4 eggs
- 1 1/2 tablespoon Adobo seasoning
- 2 cup panko breadcrumbs
- spray with olive oil
- 3-4 green onions, chopped



1. Brine chicken for 3 hours to overnight
2. Remove chicken from brine and dry thoroughly.
3. Combine rub ingredients on a plate, mix well, roll, then pat chicken legs with rub.
4. Cover and refrigerate for 3 to 4 hours.

Recipes

Roasted drumsticks

1. Add rubbed drumsticks to the air frying basket. Spray with olive oil. (optional)
2. Press  button until AIR FRY appears on the display.
Press the START/PAUSE  button to begin operation.
3. Check the cooking progress when time expires.
If more time is needed, cook at 3 minute intervals until drumsticks test done.

Air Fried drumsticks

1. Beat eggs in a medium mixing bowl. Add legs to the bowl.
2. Combine panko, green onions, and Adobo on a plate, mix well.
3. Remove legs from the egg mixture. Press breadcrumbs onto the legs.
Arrange breaded legs on a plate. Spray lightly with olive oil, cover and refrigerate for 1 hour.
4. Add breaded drumsticks to the air frying basket. Spray with olive oil. (optional)
5. Press  button until AIR FRY appears on the display.
Press the START/PAUSE  button to begin operation.
6. Check the cooking progress when time expires.
If more time is needed, cook at 3 minute intervals until drumsticks test done.

Recipes



Fried Shrimp with Homemade Cocktail Sauce

Serves 4 to 8

- 2 lb. raw shrimp, shelled and deveined
- 4 eggs, lightly beaten
- 2 cup panko breadcrumbs
- 1 1/2 tablespoon Old Bay® seasoned salt
- spray with olive oil

Cocktail Sauce

- 1/2 cup ketchup
- 1/2 cup chili sauce
- 4 tablespoons horseradish, plus more to taste
- 1 teaspoon lemon juice
- 1 teaspoon Worcestershire sauce
- 1/2 teaspoon hot sauce, plus more to taste

1. Pat shrimp dry before air frying.
2. Beat eggs in a medium mixing bowl. Add shrimp to the bowl.
3. Add panko breadcrumbs and Old Bay® seasoned salt to a gallon size zipper bag. Add drained shrimp to the bag.
4. Toss to coat and press breadcrumbs into the shrimp. Arrange breaded shrimp on a plate. Spray lightly with olive oil, cover and refrigerate for 1 hour.
5. Add breaded shrimp to frying basket. Spray with olive oil. (optional)
6. Press  button until AIR FRY appears on the display. Press the START/PAUSE  to begin operation.
7. While shrimp are cooking, prepare cocktail sauce. Add all ingredients into a small bowl and mix well.
8. Check the cooking progress when time expires. If more time is needed, cook at 2 minute intervals until shrimp are crispy and golden.
9. Serve with plenty of fresh cocktail sauce.



Recipes

Fresh Salmon with Sweet Chili Sauce

Serves 2 to 3

- 2 lb fresh salmon, filet, trimmed into 3 pieces
- 1/2 cup panko breadcrumbs
- 1/2 cup sesame seeds
- 2 teaspoon salt
- spray with olive oil



Sweet Chili Sauce

- 7 tablespoons Asian sweet chili sauce
 - 2 teaspoon Ponzu sauce
 - 2 teaspoons fresh lime juice (or lemon juice)
 - 2 teaspoon sesame seeds
 - 4 tablespoons chopped cilantro
 - 1/4 teaspoon hot sauce, (optional) plus more to taste
1. Add panko breadcrumbs, sesame seeds and salt to a gallon size zipper bag. Add salmon pieces to the bag.
 2. Carefully press breadcrumbs into the salmon. Remove to a plate. Spray lightly with olive oil, cover and refrigerate for 1 hour.
 3. Add coated salmon to frying basket. Allow air circulation on all sides of each salmon piece for best browning.
 4. Spray with olive oil. (optional)
 5. Press  button until AIR FRY appears on the display. Press the START/PAUSE  to begin operation.
 6. Check the cooking progress when time expires. If more time is needed, cook at 2 minute intervals until fish is flaky.

Recipes

Roasted Sugar Snap Peas with Sesame Seed

Serves 2 to 3

- 1 lb. fresh sugar snap peas (2 cups)
 - 2 teaspoon olive oil
 - 2 teaspoon cornstarch
 - 2 tablespoon sesame seeds
 - 1 Teaspoon sesame oil
1. Combine all ingredients in a medium bowl. Toss snap peas well to coat.
 2. Add to the air frying basket.
 3. Press  until AIR FRY appears and set at 370 °F for 6 minutes. Press the START/PAUSE  to begin operation. Shake at 3 minutes.

Recipes



Apple Stuffed Pork Chops

Serves 4-6

- 4 pork chops,
1/2 – 3/4-inch thick
- 1/2 cup flour
- 2 tablespoon cajun seasoning
- 4 eggs
- 2 cup seasoned
panko breadcrumbs
- spray with olive oil
- toothpicks or
metal skewers to seal

Stuffing

- 4 small apples, peeled, cored
and chopped into small pieces
- 3/4 teaspoon allspice
- 3/4 teaspoon salt (to taste)



1. Slit each pork chop through the center, from the fatty side to the bone to create a pocket. Place the chopped apples into a small bowl. Add allspice and salt and toss to coat apples well. Stuff chops with apple mixture. Use toothpicks or skewers to secure.
2. Hold each chop tightly closed and dredge each side of the chop in flour. Pat the outside gently with your hands to remove any excess.
3. Dip both sides into egg; use a fork to press and coat both sides with panko breadcrumbs.
4. Add breaded pork chops to the air frying basket. Spray with olive oil. (optional)
5. Press  until AIR FRY appears on the display. Press the START/PAUSE  to begin operation.

NOTE: Depending on the thickness of the chops and the amount of apple stuffing, it may be necessary to use a meat thermometer to check cooking progress halfway through cooking time to determine final cook time and temperature. If more time is needed, cook at 5 minute intervals until pork tests 160 °F.

Recipes

Cauliflower-Tots

Makes: 22 – 24 tots

- 2 cups cauliflower florets
 - 1/2 cup breadcrumbs, seasoned
 - 1/2 cup Parmesan cheese, grated
 - 4 tablespoons chopped parsley
 - salt
 - 2 eggs, lightly beaten
1. Steam cauliflower for 3 minutes.
 2. Use food processor to chop cauliflower to the size of large breadcrumbs.
 3. Line a colander with a clean kitchen towel and add the cauliflower. Fold the towel over the top and gently press to remove as much liquid as possible.
 4. Transfer the dried cauliflower to a large mixing bowl. Add breadcrumbs, Parmesan, parsley, salt and mix well.
 5. In a small bowl, mix the eggs, then add to the cauliflower. Mix by hand and form into 1-inch round or slightly oblong tots. Place formed tots onto a plate, then into the refrigerator to cool for 1 hour to overnight.
 6. Add breaded tots to the air frying basket. Spray with olive oil. (optional)
 7. Press  until AIR FRY appears and set at 370 °F for 16 minutes. Press the START/PAUSE  to begin operation. Shake at 8 minutes.

Recipes



Mango Blueberry Ginger Crumble

Serves 4 to 6

- 2 cups fresh mango
- 1/2 cup fresh blueberries
- 3/4 teaspoons fresh grated ginger
- 1/4 teaspoons ground ginger
- 2 tablespoons sugar

Crumble Topping

- 7/8 cup flour
- 4 tablespoons cold butter, chopped
- 1/4 cup brown sugar
- 1 tablespoon lemon juice
- 1/2 cup chopped pecans
- salt
- 7-inch round oven or aluminum foil pan

1. Cut mango into chunks and place into a bowl. Add the blueberries, grated ginger, ground ginger, 2 tablespoons sugar and mix well.
2. Scoop the fruit mixture into the aluminum foil pan. Spread evenly.
3. In a bowl, mix the flour with a pinch of salt and the remaining sugar. Add the butter and lemon juice. Rub flour and butter together with your fingertips until a crumbly mixture is achieved. Add chopped nuts.
4. Distribute the crumble mixture evenly over the fruit and lightly press down.
5. Press  **MENU** until **BAKE** appears on the display. Press the **START/PAUSE**  to begin operation.
6. Check the baking progress of the crumble at 3 minutes before time expires. If there is too much liquid, increase **TEMPERATURE** up to 390 °F and continue to cook until top is brown.

Limited Two-Year Warranty

SENSIO Inc. hereby warrants that for a period of **TWO YEARS** from the date of purchase, this product will be free from mechanical defects in material and workmanship, and for 90 days in respect to non-mechanical parts. At its sole discretion, SENSIO Inc. will either repair or replace the product found to be defective, or issue a refund on the product during the warranty period.

Exclusions:

The warranty does not cover normal wear of parts or damage resulting from any of the following: negligent use of the product, use of improper voltage or current, improper routine maintenance, use contrary to the operating instructions, disassembly, repair, or alteration by anyone other than qualified SENSIO Inc. personnel. Also, the warranty does not cover Acts of God such as fire, floods, hurricanes, or tornadoes.

SENSIO Inc. shall not be liable for any incidental or consequential damages caused by the breach of any express or implied warranty. Apart from the extent prohibited by applicable law, any implied warranty of merchantability or

The warranty is only valid for the original retail purchaser from the date of initial retail purchase and is not transferable. Keep the original sales receipt, as proof of purchase is required to obtain warranty validation. Retail stores selling this product do not have the right to alter, modify, or in any way revise the terms and conditions of the warranty.

fitness for a particular purpose is limited in time to the duration of the warranty. Some states, provinces or jurisdictions do not allow the exclusion or limitation of incidental or consequential damages, or limitations on how long an implied warranty lasts, and therefore, the above exclusions or limitations may not apply to you. The warranty covers specific legal rights which may vary by state, province and/or jurisdiction.

How To Obtain Warranty Service:

You must contact Customer Service at our toll-free number: 1-866-832-4843. A Customer Service Representative will attempt to resolve warranty issues over the phone. If the Customer Service Representative is unable to resolve the problem, you will be provided with a case number and asked to return the product to SENSIO Inc. Attach a tag to the product that includes: your name, address, daytime contact telephone number, case number, and description of the problem.

Also, include a copy of the original sales receipt. Carefully package the tagged product with the sales receipt, and send it (with shipping and insurance prepaid) to SENSIO Inc.'s address. SENSIO Inc. shall bear no responsibility or liability for the returned product while in transit to SENSIO Inc.'s Customer Service Center.



For customer service questions or comments
1-866-832-4843
bellahousewares.com

Sensio Inc.
New York, NY 10016/USA

90165 90168 90177 12