

# SOLIS SKIPPER PENDANT

Tom Raffield

## Product Specification

Solis Skipper Pendant Small

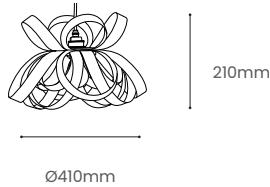

Solis Skipper Pendant

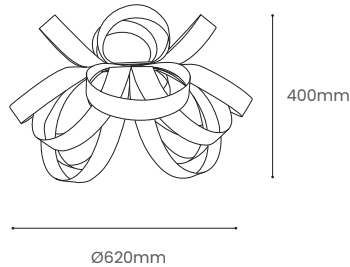



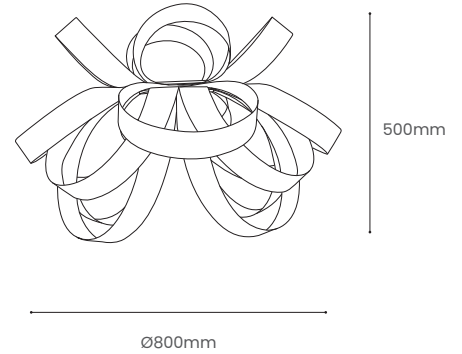

Solis Skipper Pendant Large



Undulating loops of timber navigate over and around. Where pared back design meets our signature curves, the Skipper Lighting Range leads the charge.

The Solis Skipper Pendant merges Scandinavian design principles with our signature aesthetic. Crafted from beautiful whitened oak, this achromatic pendant features a hand-shaped open structure that radiates light upward and outward, creating a captivating interplay of brightness and shadow. This truly timeless design suits any space, from bustling kitchens, to calming bedrooms, for decades to come.

Achieve impact with a lighter touch. Embrace simplicity. Make a statement in your space.

Product Type : Pendant Light	SKU	Wood types	Dimensions L x W x H (mm)		Weight (kg)		
			Unboxed	Boxed	Unboxed	Boxed	
Skipper Pendant Small	TR-SOL-SKIP-P-SML	Whitened Oak	Ø410 x 210	470 x 470 x 330	0.2	1.3	
Skipper Pendant	TR-SOL-SKIP-P	Whitened Oak	Ø620 x 400	615 x 615 x 490	0.6	3.65	
Skipper Pendant Large	TR-SOL-SKIP-P-LRG	Whitened Oak	Ø800 x 500	745 x 745 x 570	1.15	4.8	
Materials	Whitened Oak 					Other materials	
						Birch ply hanging disk 	
Finish	Non-toxic, hard wearing water based varnish - satin						
Wiring kit option : 1	Black ceiling rose and brass bulb holder 	Ceiling kit	Flex		Recommended light bulb		
		Ceiling rose: Ø100mm E27 (240v) / E26 (110v)	Flex colour: black fabric Flex length: 2m (Adjustable)		Max 25W LED		
Wiring kit option : 2	Brushed steel ceiling rose and bulb holder 	Ceiling kit	Flex		Recommended light bulb		
		Ceiling rose: Ø100mm E27 (240v) / E26 (110v)	Flex colour: light grey fabric Flex length: 2m (Adjustable)		Max 25W LED		
Care information	Dusting your light regularly and with a light feather duster should keep your light looking clean, otherwise wipe with a damp cloth and remove any moisture with a dry cloth. Gentle furniture polishes can also be used.						
Additional information	<ul style="list-style-type: none"> <li>This light can be used with your existing E27/E26 pendant fitting. Suitable for use on 240v and 110v circuits.</li> <li>A shade ring adaptor can be fitted so the light can be used on a bayonet (B22) pendant fitting.</li> <li>Installation instructions included.</li> </ul>						