

**retrospec**

# **Weekender**

Inflatable Stand Up Paddle Board



**OWNER'S MANUAL**

# Oh, hey!

Welcome to the **retrospec** family! We're so happy to have you along for the ride. Your new inflatable paddle board comes with everything you need to make a splash.

## **A little about us:**

The outside is for everyone, but not everyone feels comfortable outside. So we set out to make everyone feel at home in the open air. We believe that all people, regardless of background or experience, should enjoy the life-affirming, eye-opening beauty of nature.

## **The retrospec Pledge:**

- ★ Invite everyone, regardless of experience
- ★ Focus on having fun, not being first
- ★ Be nice. It's that simple.
- ★ Keep spirits high, even if energy is low
- ★ Leave judgment at the doorstep

## **Turns out, you're a natural.**

It doesn't have to be intense to be super fun, but you know that. Regardless of your experience, we're here to guide you at every step so you can feel at home outside.

## **Need some help? Hit us up:**



# Table of Contents

Safety Warnings	2-4
What's Included in Your Box	5
Caring for Your iSUP	5-6
Inflation Instruction	6-7
Accessory Installation & Setup	7-8
Deflation & Storage	9
ADD ON: Kayak Seat Installation	10-12
ADD ON: iSUP Carry Sling Use	12
General Use Information	13
Warranty	13-14
Contact Us	15

## Let's Keep It Safe Out There



### **⚠ WARNING!**

**Paddlesports can be very dangerous and physically demanding. The user of this product must understand that participation in paddlesports may involve serious injury or death.**

**Failure to follow the warnings; precautions; and instructions below and throughout this manual may lead to serious injury or death.**

**Do not exceed your physical ability or skill level.**

Determine how long you are able to paddle or swim before using your iSUP. Do not paddle in conditions that are above your skill or experience level.

**Learn from a professional.**

Take a lesson or safety course to get hands-on training from a local paddle sport outfitter or look online for accredited educational content and certified instructors.

**Always paddle with others.**

Avoid paddling alone.

**Avoid riding your board through shallow water.**

Fins may strike submerged objects causing damage to the fins and/or fin boxes which is not covered by warranty.

**Stay hydrated and bring a snack.**

Make sure you drink plenty of water and keep yourself properly fueled.

**Always wear a leash.**

Make sure you wear the right kind of leash for the environment you are paddling in. In lakes, bays, and open water where there is no risk of snag or entrapment, wear a coiled ankle or knee leash. The leash included with your paddle board is not intended for use with a surfboard. If you are paddling in swift or moving water where there is a risk of snag or entrapment, you must wear a waist leash with a quick release safety system.

**Always wear a US Coast Guard approved personal flotation device (PFD).**

Federal law requires that PFDs are used on SUPs outside of a surfing, swimming, or bathing area. Wear it!

**Carry a whistle on board.**

Required by federal law (beyond a surfing, swimming, or bathing area) and allows you to signal other boaters.

**Never use this paddleboard after sunset.**

Required by federal law, always carry a waterproof flashlight in case you are caught in the water after dark to warn other boaters of your presence.

**Always check the weather before heading onto the water.**

Don't use your paddle board in severe weather, if you see or hear lightning or thunder, or in strong windy conditions. Stay aware and know that conditions can change quickly.

**Hypothermia can cause death.**

Check water and air temperatures and dress appropriately. Hypothermia can occur in relatively warm water. Survival time decreases dramatically as water temperature drops –

as quickly as 15 minutes in 35 degree fahrenheit water (2 degrees celsius). Wear a wet or dry suit when necessary.

**Familiarize yourself with the body of water where you plan on using your board.**

Check for any known hazardous areas, hours of operation, and where the nearest help can be reached in case of emergency. Check local guides or online/apps resources for information on currents and tides, if applicable. Familiarize yourself with and abide by local boating traffic and navigation laws/regulations.

**Wear slip resistant footwear.**

Deck materials may become slippery when wet and pose a slip hazard.

**Inform others of your paddling plans.**

Where you plan to go and how long you plan to be gone.

**Minors must be supervised and wear a US Coast Guard approved PFD at all times.**

**DO NOT consume alcohol/drugs; this may affect your ability to safely operate this board.**

**Pay attention to your surroundings.**

Always come to a kneeling or seated position when launching or landing from a dock or if you find yourself in shallow water. Do not paddle near dams, piers, pilings, rocks, or other hard objects or obstructions.

# What's in the Box?

**If you're missing any of these items, please let us know as soon as possible!**

- Your new rolled-up inflatable stand up paddle board (iSUP)
- Floor hand-pump with integrated gauge & quick attach hose
- 3 piece aluminum length-adjustable paddle
  - ◆ 4 piece paddle for Plus models
- Backpack
- Fins
  - ◆ Weekender/Weekender XL/Nano/Yogi/Plus/Tour - 3 pieces
  - ◆ Weekender Crew/Crew XL - 5 pieces
  
- Waterproof smartphone case
- Leash
- Repair Kit with 2 PVC repair patches and 1 air valve wrench.
- Plus Models also include:
  - ◆ Weekender Carry Sling
  - ◆ AerComfort Kayak Seat

# What's Not in the Box?

**(but you might want anyway for safety and security)**

- US Coast Guard Approved Personal Flotation Device (PFD)
- UV 30+ protective clothing
- Slip-resistant footwear
- Waterproof flashlight
- Sunscreen
- Whistle
- Hat
- Sunglasses and lanyard

# Caring for Your iSUP

We have a feeling you're going to love your new board. There are a few things you should know about caring for your board before hopping on. Hey, we all need some TLC.

**Do not store your board (inflated or uninflated) in direct sunlight or excessive heat conditions**, such as inside a closed vehicle. Excessive heat will increase the pressure in the board beyond the recommended PSI and may cause irreversible damage.

If you must store your inflated board in the sun temporarily, protect it by placing it in the shade or by covering it with a towel. Always release a small amount of air pressure to allow it room to expand from the heat. Pump it back to full pressure before using it again.

**Rinse your board and accessories with fresh water after every use.** This removes salt, sand, and debris which can damage your equipment over time. Allow to dry thoroughly before storing.

**Deflate your board after every use.** To protect your iSUP and maximize its lifespan, do not store your board fully inflated.

**Do not transport your SUP fully pressurized.** Traveling from low to high altitudes will increase air pressure in the chamber and can damage your board due to over-pressurization.

**Properly roll your board.** Roll your board from the nose toward the valve end and allow the board to deflate completely.

## Inflation Instructions

### 1. Preparing the Board:

Find a clean, flat surface free of any debris or sharp objects and unroll your paddle board with the deck and valve facing up.

### 2. Preparing the Valve:

Remove the valve cover. Before you start to inflate the board, make sure the inflation valve stem is closed to keep air from escaping (in the UP position). If the inflation valve stem is down and air is escaping, press and turn the valve stem so that it pops back up.

### 3. Assembling the Pump:

Your pump can be used for inflation and deflation. Screw the pump hose into the opening marked "Inflate" on the pump handle.

### 4. Secure the Hose to the Board:

Push the hose into the air valve and twist clockwise until you feel it lock onto the valve.

## 5. Inflating the Board:

Begin pumping air into the board. Note that the pressure gauge will not register pressure until the board reaches 10 PSI. The board will begin to take shape after 4min/100 full pumps. Once the board reaches the desired pressure (15 PSI/225 full pumps), remove the hose from the valve and replace the valve cap onto the valve body. Recommended pressure is 12-15 PSI. Check pressure before each use.

## 6. WARNING! Do Not Exceed the Recommended Pressure!

Do not use an unregulated air compressor to fill the board. Exceeding the recommended pressure will permanently damage the board and void the warranty.

## 7. If the valve leaks:

Use the supplied air valve wrench from the repair kit to tighten the valve clockwise and stop the leak.

	Weekender 10'6"	Weekender XL 11'	Weekender Plus 10'6"	Weekender Yogi 10'8"	Weekender Tour 11'6"	Weekender Nano	Weekender Crew 12'	Weekender Crew XL 15'
Compatible with Seat	275	400	300	275	300	140	500	1200
Kayak Seat Included	12	12-15	.15	12.	15	12	12	12

# Accessory Installation & Setup

## Fin Installation

### Tri-Fin & 5 Fin Models:

1. Slide the central fin into the center mounting slot and lock it in place by inserting the locking pin into the base.
2. Slide the two smaller outer fins (4 fins for Weekender Crew) into the two side slots (4 for Weekender Crew) and lock them in place by inserting the locking pins into the bases.
3. Some force may be necessary to fully insert the fins into their slots.
4. Always check the fins to be certain they are securely attached before using the board.



## How to Attach Your Leash

Make sure you use the proper leash for the water conditions you are paddling in! Refer to above, "Always wear a leash."

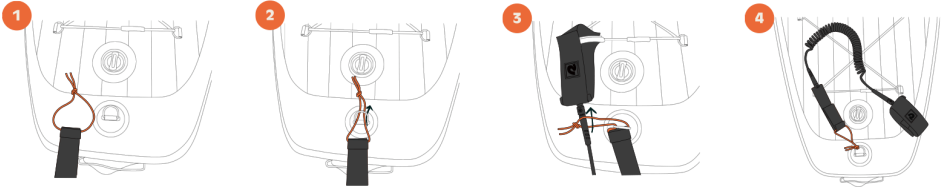

## How to adjust & tighten your paddle

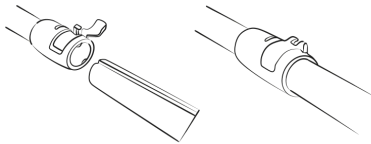

Before use, rotate the lock to secure the handle.

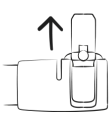

1) Open Lock

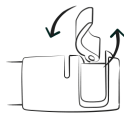

2) Rotate

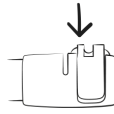

3) Secure Lock

## Paddle Size Guide:

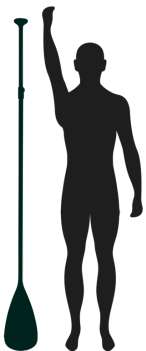

Stand holding the paddle next to you.

With your arm raised, the paddle's handle should reach your wrist.

Adjust the paddle so that it's comfortable for you. Unlock the clasp, slide the paddle shaft to the desired height, and relock the clasp.

# Deflation & Storage

## Fins, Leash, and Paddle

- 1. Fin Removal, Tri-Fin & 5-Fin Models:** Lay board with fins facing up on a clean flat surface free of any debris or sharp objects. Remove the center and side fins by pressing the tabs on the locking pins and sliding them out of their mounts. Store fins in backpack until next use.
- 2. Leash Removal:** Detach the leash, rinse with fresh water, and let air dry before storing in the backpack.
- 3. Paddle:** Detach/break down 3-piece paddle. Rinse inside and outside with fresh water and let air dry before storing in the backpack.

## iSUP

### 1. Clean and Dry the Board:

With the board inflated and the valve closed, rinse the board with fresh water to clean off any sand or debris. Allow the board to dry completely. Do not store board while still wet to prevent mildew buildup.

### 2. Deflating the Board:

- a. Once the valve area is dry, remove the valve cap, keeping your face away from the valve, as the air will escape rapidly at first and could cause harm.
- b. Press down lightly on the inflation valve stem to release some of the air – which will slow down after the initial strong burst.
- c. Press and turn the inflation valve stem to lock the stem in the open (DOWN) position to fully deflate the board.

### 3. Rolling up the Board:

- a. With the board deflated and the valve still open, start at the nose of the board, opposite from the valve. Fold 3 inches over and roll up the board until reaching the valve.
- b. Close the valve stem by turning the inflation valve stem to the UP / closed position and replace the valve cap.
- c. Wrap the strap around the rolled-up board and fasten the buckle.

## Storage

Place your rolled-up iSUP back into its backpack and store in a safe place. Make sure it is protected from the elements, extreme heat or cold.

PLEASE NOTE: To maximize the lifespan of your board, do not store the board fully inflated (not even temporarily). It is important to deflate the board after every use.

# AerComfort Kayak Seat (Add On)

**WARNING!** Before you attach the kayak seat, remove the fins so that you can position the seat comfortably on land before getting onto the water. DO NOT sit or stand on your stand up paddleboard with the fins installed while on land. Doing so can permanently damage your board and fins, possibly lead to injury, and is not covered by warranty.

	Weekender 10'6"	Weekender XL 11'	Weekender Plus 10'6"	Weekender Yogi 10'8"	Weekender Tour 11'6"	Weekender Nano 8'	Weekender Crew 12'	Weekender Crew XL 15'
Compatible with Seat	✗	✓	✓	✗	✓	✗	✓	✓
Kayak Seat Included	✗	✗	✓	✗	✗	✗	✗	✗

**Weekender Plus, Tour,  
& XL**

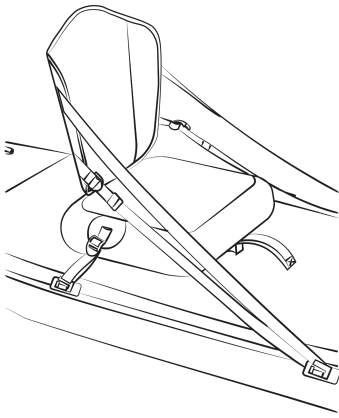

**Weekender Crew & Crew XL**

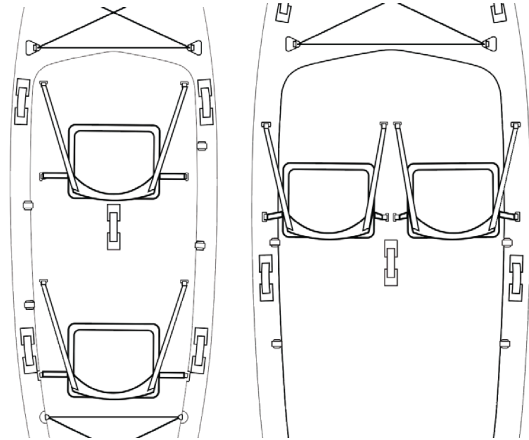

## **Inflate the AerComfort Seat Cushion**

### **Find a clean, flat surface and remove the valve cover:**

Before inflating the seat cushion, make sure the inflation valve stem is closed to keep air from escaping (in the UP position). If the inflation valve stem is down and air is escaping, press and turn the valve stem so that it pops back up.

#### **1. Secure the pump hose to the seat cushion:**

Push the hose into the air valve and twist clockwise until you feel it lock onto the valve.

- #### **2. Inflating the seat cushion:**
- Pump air into the seat cushion. The recommended pressure range is 7-10 PSI. Once the cushion reaches the desired pressure remove the hose from the valve and replace the valve cap onto the valve body. Check pressure before each use.

## **Attach the AerComfort Seat to Your Board**

1. Make sure your board is on a flat, clean surface. If your fins are already installed, DO NOT sit on the kayak seat while on land, as this may damage the fins.
2. Place the inflatable kayak seat in the desired location near the center of the board facing the front of the board.
3. Locate the 2 sets of kayak seat EasyLink loops on each side of the board.
4. Secure the seat cushion first. Connect the G-hooks on the cushion straps to the rear EasyLink loops on the side of the board. Tighten the straps to firmly secure the cushion to the board.
5. Next, connect the G-hook on the backrest straps to the front EasyLink loops on the sides of the board.
6. Using the ladder lock buckle on the backrest straps, tighten or loosen to adjust the seat to a comfortable position.

## **Convert Your SUP Paddle to a Kayak Paddle**

An additional paddle blade is included with Weekender Plus. The convertible paddle may be bought separately for Weekender Tour, Weekender XL and Weekender Crew (size XL paddle recommended). To convert your SUP paddle to a kayak paddle, remove the T-grip handle of the paddle and replace it with the additional kayak blade.

## How to Deflate the AerComfort Seat Cushion

### 1. Clean and Dry the Seat:

With the seat inflated and the valve closed, rinse the seat with fresh water to clean it of any sand or debris. Allow the seat to dry completely (but not in direct sun for extended time). Do not store seat while still wet to prevent mildew buildup.

















### 2. Deflating the Seat Cushion:

- Once the valve area is dry, remove the valve cap, keeping your face away from the valve, as the air will escape rapidly at first and could cause harm.
- Press down lightly on the inflation valve stem to release some of the air – which will slow down after the initial strong burst.
- Press and turn the inflation valve stem to lock the stem in the open (DOWN) position to fully deflate the seat.
- Once the seat is fully deflated, close the valve stem by turning the inflation valve stem to the UP/closed position and replace the valve cap.

**3. Rinse your seat to remove any sand, salt, or debris and allow to dry fully before storing.**

## Weekender iSUP Carry Sling (Add On)

The Weekender iSUP Carry Sling helps make your journey to and from the water even easier. Simply insert the G-hooks in the EasyLink Connection loops on the side of the board. Wear over either shoulder, whichever is most comfortable.

	Weekender 10'6"	Weekender XL 11'	Weekender Plus 10'6"	Weekender Yogi 10'8"	Weekender Tour 11'6"	Weekender Nano 8'	Weekender Crew 12'	Weekender Crew XL 15'
Compatible with Sling								
Carry Sling Included								

# General Use Information

- 1.** Adjust your paddle to the proper height before bringing your board in the water. To measure, reach one hand up like you're asking a question in a class. Keeping your shoulder relaxed and standing your paddle upright on the floor, your paddle handle should come to about your wrist. Your paddle is adjustable, so you can try different heights until you find the one that is the most comfortable for you.
- 2.** To hold the paddle, place one hand on top of the paddle handle. Place the other hand on the shaft of the paddle so that your hands are about a push-up distance apart. Make sure you are holding your paddle with the scoop side of the blade facing back.
- 3.** For a stable standing position, stand at the center of the board facing forward with your feet approximately shoulder width apart and your knees slightly bent, eyes looking towards the horizon.
- 4.** To go straight, paddle on either the left or right side, alternating sides when you need to – you don't need to alternate with every stroke. Make sure your paddle blade stays right along the side of the board.
- 5.** For turns, hold your paddle in a more horizontal position and use wide, sweeping strokes. To turn left, paddle on the right side of the board. To turn right, paddle on the left side.

**How to get back on your board from the water:** Position yourself alongside the board so that you can reach the center grab handle. Reach across the board, pull with your arms and kick with your legs to bring your stomach onto the center of the deck. Once you are on, swivel your legs and hips onto the board so that you are laying fully prone. If you need to go get your paddle, you can paddle like a surfer using your arms. When you are ready, return to a kneeling or standing position.

## Warranty

**retrospec warrants manufacturer defects on all paddleboards for up to two years from the date of purchase. We warrant against any manufacturer defect in workmanship and materials during this two-year window. Determining manufacturer defect is at the sole discretion of retrospec. We reserve the right to request images or otherwise for proof of manufacturer defect. This warranty commitment does not cover claim conditions listed below.**

**This warranty commitment for inflatable stand up paddle boards (iSUPs) does not cover claim conditions including:**

Damage or defects incurred by impact with any damaging materials or objects including, but not limited to rocks, shoals, docks, other boards, boats, etc. are NOT covered by the warranty.

Damage or defects incurred by use outside of the board's intended purpose is NOT covered by the warranty.

Damage incurred due to normal wear and tear of the board is NOT covered by warranty.

Damage or defects incurred by transporting, loading, unloading, dropping, or general mishandling of the board is NOT covered by the warranty.

Damage or defects incurred due to incorrect prolonged storage of board including, but not limited to storing in extreme temperatures over 90°F and/or under 32°F, prolonged exposure to direct sunlight while not in use, storage while fully inflated, or prolonged storage in closed, damp conditions is NOT covered by the warranty.

Boards used in rental, commercial, classes, or otherwise are NOT covered under warranty.

Damage incurred by improper forcing, shoving, or general improper fin installation are NOT covered by the warranty.

Improper use of air valve wrench/repair kit contents are NOT covered under warranty.

Any modifications made to your inflatable stand up paddleboard including, but not limited to, the replacement of parts or components with non-original equipment or the addition of aftermarket motors, seats, or otherwise voids the warranty.



## Contact Us

Need some help with your new gear? Just want to say “hey” and talk to someone on our team? We’re here for that too.

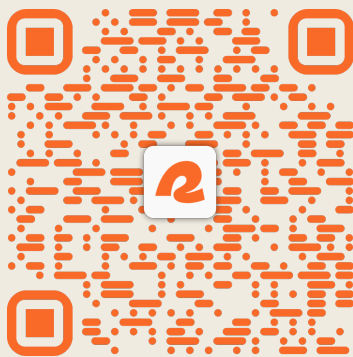

Give us a follow, while you’re at it:

@retrospec

#retrospec

#readytooutdoor