

Truss Accessories

Add your creativity





Truss Accessories

- All types of connectors
- Aluminium base plates
- Heavy-duty plates
- Male & female cube connectors
- Ceiling supports
- Plastic clips
- Connection sets



CCM

Series	kg	lbs
M222	0.06	(0.13)

Conical connector M



PM|PIN

Series	kg	lbs
M222	0.02	(0.04)

Pin M



PMM6SET

Series	kg	lbs
M222	0.02	(0.04)

Pin M with M6 thread
Supplied with washer and nylock nut.



CCMM8|MALE

Series	kg	lbs
M222	0.03	(0.07)

Half connector M with M8 thread
Fixing screw not included (order separately if required)



SRPM

Series	kg	lbs
M222	0.01	(0.01)

Safety R Clip M



CCMD10

Series	kg	lbs
M222	0.08	(0.18)

Spacer M 10 mm (0.39")



CCMD20

Series	kg	lbs
M222	0.10	(0.22)

Spacer M 20 mm (0.79")



CCMD30

Series	kg	lbs
M222	0.12	(0.26)

Spacer M 30 mm (1.18")



CCMD40

Series	kg	lbs
M222	0.14	(0.31)

Spacer M 40 mm (1.58")

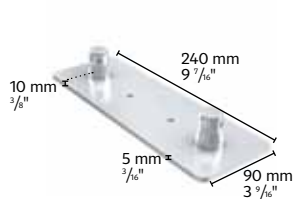

MWPDC|MALE

Series	kg	lbs
M222	0.40	(0.88)

Duo base plate with half connectors
Base plate includes mounting holes

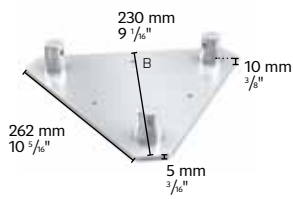

MWPTC|MALE

Series	kg	lbs
M222	0.60	(1.32)

Trio base plate with half connectors
Base plate includes mounting holes

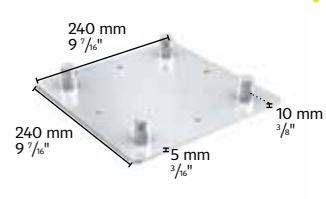

MWPQC|MALE

Series	kg	lbs
M222	0.94	(2.07)

Quatro base plate with half connectors
Base plate includes mounting holes

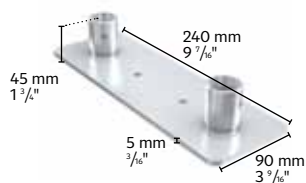

MWPD|FEMALE

Series	kg	lbs
M222	0.50	(1.10)

Duo base plate with female receivers
Base plate includes mounting holes



MWPT|FEMALE

Series	kg	lbs
M222	0.70	(1.54)

Trio base plate with female receivers
Base plate includes mounting holes

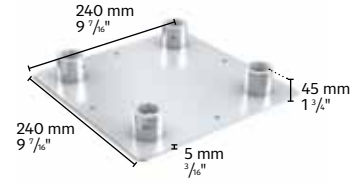

MWPQ|FEMALE

Series	kg	lbs
M222	1.04	(2.29)

Quatro base plate with female receivers
Base plate includes mounting holes

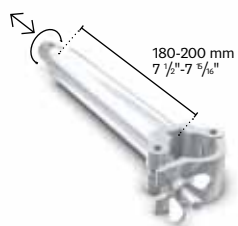

CON03M|CELL

Series	kg	lbs
M222	0.27	(0.60)

Clamp extension long
For 32 mm (1.26") tubes

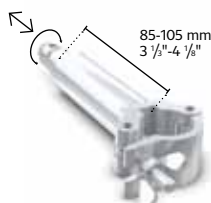

CON04M|CELL

Series	kg	lbs
M222	0.24	(0.53)

Clamp extension short
For 32 mm (1.26") tubes

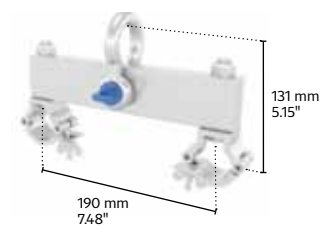

CS-M222

Series	kg	lbs
M222	1.2	(2.64)

Ceiling support for M222
SWL 250 kg (551 lbs)

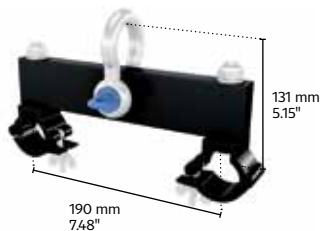

CS-M222|COLOR

Series	kg	lbs
M222	1.2	(2.64)

Ceiling support for M222
SWL 250 kg (551 lbs)



CON85M|FEMALEPIN

Series	kg	lbs
M222	0.08	(0.18)

Female fitting for Multicube QC-M222
Supplied with washer and M10x25 bolt.

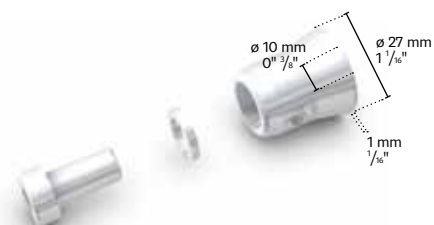

CON77M|MALEPIN

Series	kg	lbs
M222	0.07	(0.15)

Male fitting for Multicube QC-M222
Supplied with washer and M10x16 bolt.



CON19M|PARCELTRIO

Series	kg	lbs
M222	0.30	(0.66)

Connection set - TRIO truss
3x CCM, 6xPM|Pin, 6x SRPM



CON20M|PARCELQUATRO

Series	kg	lbs
M222	0.40	(0.88)

Parcel quatro (4xCCM, 8xPM, 8xSRPM)x
Connection set for QUATRO truss



CON18M|PARCELDUO

Series	kg	lbs
M222	0.20	(0.44)

Connection set - DUO truss
2x CCM, 4xPM|Pin, 4x SRPM



CCB

Series	kg	lbs
M290	0.11	(0.24)
M290E		
M390		
M290x390		

Conical connector B
F & U compatible versions available

PB|PIN

Series	kg	lbs
M290	0.05	(0.11)
M290E		
M390		
M290x390		

Pin B

PBM8SET

Series	kg	lbs
M290	0.08	(0.18)
M290E		
M390		
M290x390		

Pin B with M8 thread
Supplied with washer and nylock nut.



PBM8SSSET

Series	kg	lbs
M290	0.08	(0.18)
M290E		
M390		
M290x390		

Stainless steel Pin B with M8 thread
Supplied with washer and nylock nut.

CCBM10|MALE

Series	kg	lbs
M290	0.07	(0.15)
M390		
M290x390		

Half connector B with M10 thread
Fixing screw not included (order separately if required)
F&U compatible versions available

CCBM12|MALE

Series	kg	lbs
M290	0.12	(0.26)
M390		
M290x390		

Half connector B with M12 thread
Fixing screw not included (order separately if required)
F&U compatible versions available

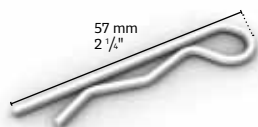

SRPB

Series	kg	lbs
M222		
M290E		
M390	0.002	(0.01)
M290x390		

Safety R Clip B



CCBD10

Series	kg	lbs
M290		
M390	0.20	(0.44)
M290x390		

Spacer B 10 mm (0.39")
F & U compatible versions available



CCBD20

Series	kg	lbs
M290		
M390	0.25	(0.55)
M290x390		

Spacer B 20 mm (0.79")
F & U compatible version available



CCBD30

Series	kg	lbs
M290		
M390	0.30	(0.66)
M290x390		

Spacer B 30 mm (1.18")
F & U compatible version available



CCBD40

Series	kg	lbs
M290		
M290E		
M390	0.36	(0.79)
M290x390		

Spacer B 40 mm (1.58")
F & U compatible version available



CCBD50

Series	kg	lbs
M290		
M290E		
M390	0.41	(0.90)
M290x390		

Spacer B 50 mm (2")
Various lengths available on request
F & U compatible version available

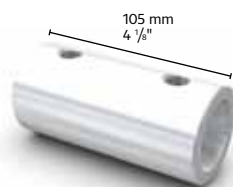

CFBD105

Series	kg	lbs
M290		
M390	0.33	(0.73)
M290x390		

105 mm (4.13") female spacer
F & U compatible version available

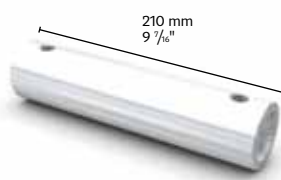

CFBD210

Series	kg	lbs
M290		
M390	0.68	(0.84)
M290x390		

210 mm (8.27") female spacer
F & U compatible version available



BBPSC|MALE

Series	kg	lbs
M100		
M290		
M390	0.19	(0.42)
M290x390		

Base plate with half connector
F & U compatible version available

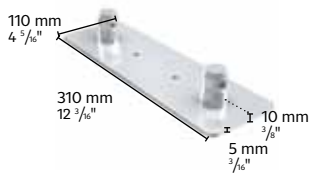

BWPDC|MALE

Series	kg	lbs
M290	0.64	(1.41)

Duo base plate with half connectors
Base plate includes mounting holes F & U compatible versions available



BWPTC|MALE

Series	kg	lbs
M290	1.08	(2.38)

Trio base plate with half connectors
Wall plates have mounting holes F & U compatible versions available

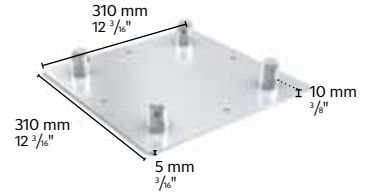

BWPQC|MALE

Series	kg	lbs
M290	1.65	(3.64)

Quatro base plate with half connectors
Base plate includes mounting holes F & U compatible versions available

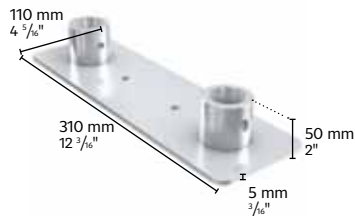

BWPD|FEMALE

Series	kg	lbs
M290	0.74	(1.63)

Duo base plate with female receivers
Base plate includes mounting holes F & U compatible versions available

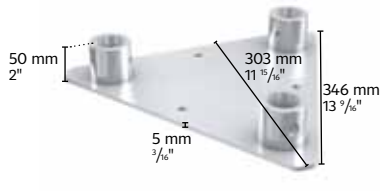

BWPT|FEMALE

Series	kg	lbs
M290	1.23	(2.71)

Trio base plate with female receivers
Base plate includes mounting holes F & U compatible versions available

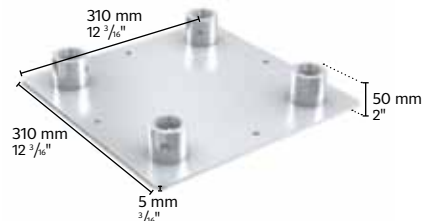

BWPQ|FEMALE

Series	kg	lbs
M290	1.86	(4.09)

Quatro base plate with female receivers
Base plate includes mounting holes F & U compatible versions available

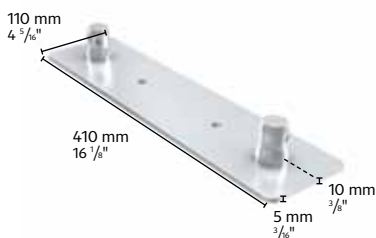

KWPDC|MALE

Series	kg	lbs
M390	0.79	(1.68)

Duo base plate with half connectors
Base plate includes mounting holes F compatible versions available

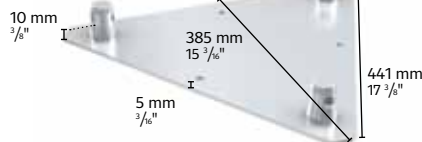

KWPTC|MALE

Series	kg	lbs
M390	1.57	(3.46)

Trio base plate with half connectors
Base plate includes mounting holes F compatible versions available

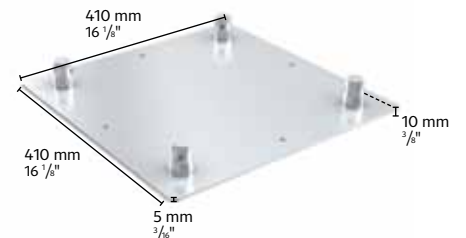

KWPQC|MALE

Series	kg	lbs
M390	2.63	(5.80)

Quatro base plate with half connectors
Base plate includes mounting holes F compatible versions available

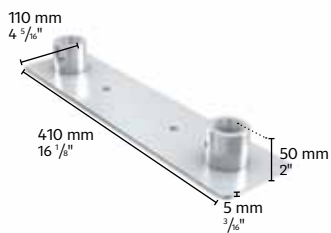

KWPQ|FEMALE

Series	kg	lbs
M390	0.89	(1.96)

Duo base plate with female receivers
Base plate includes mounting holes
F compatible versions available

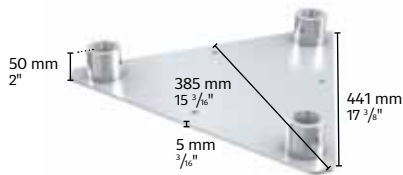

KWPT|FEMALE

Series	kg	lbs
M390	1.73	(3.81)

Trio base plate with female receivers
Base plate includes mounting holes
F compatible versions available

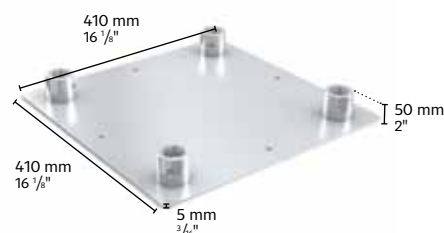

KWPQ|FEMALE

Series	kg	lbs
M390	2.83	(6.24)

Quatro base plate with female receivers
Base plate includes mounting holes
F compatible versions available

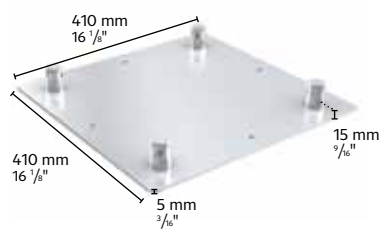

OBPQC|MALE

Series	kg	lbs
M400	3.10	(6.83)

Quatro base plate with half connectors

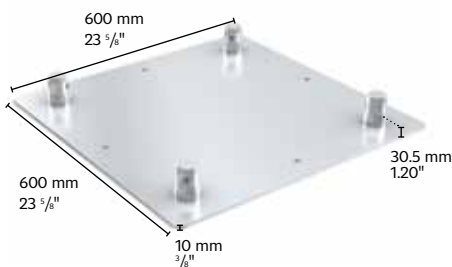

PBPQC|MALE

Series	kg	lbs
M520	10.85	(23.92)

Quatro base plate with half connectors

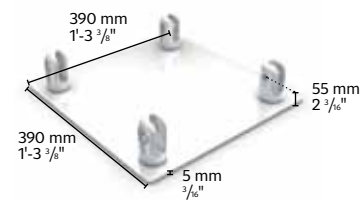

4GS-35-BPF

Series	kg	lbs
4GS-35	2.84	(6.26)

Female base plate

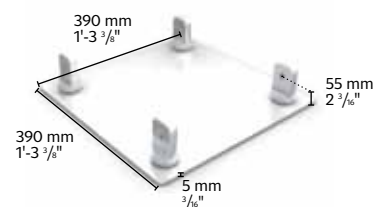

4GS-35-BPM

Series	kg	lbs
4GS-35	2.77	(6.11)

Male base plate

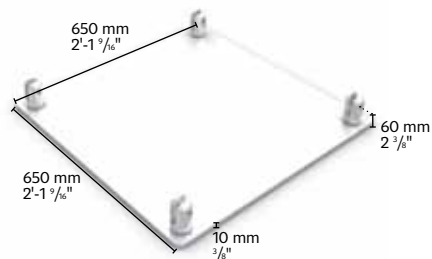

4GS-62-BPF

Series	kg	lbs
4GS-62	12.71	(28.02)

Female base plate

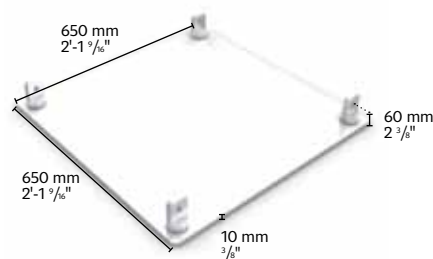

4GS-62-BPM

Series	kg	lbs
4GS-62	12.20	(26.90)

Male base plate

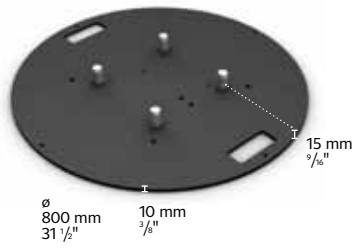

BBPD800|QTB|STEEL

Series	kg	lbs
M222		
M290	38.58	(85.05)
M390		

Round steel base plate with half connectors
Pre-drilled holes for multiple truss ranges & shapes
F & U compatible versions available

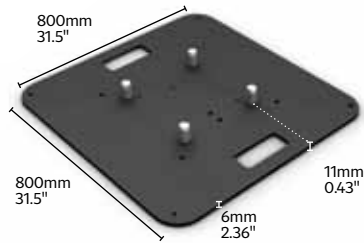

BBP600X600X10|QTB|STEEL

Series	kg	lbs
M222		
M290	27.14	(59.83)
M390		

Steel base plate with half connectors
Pre-drilled holes for multiple truss ranges & shapes
F & U compatible versions available

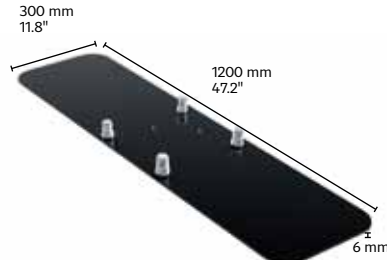

BBP600X600X6|QTB|STEEL

Series	kg	lbs
M222		
M290	16.1	(35.5)
M390		

Steel base plate with half connectors
Pre-drilled holes for multiple truss ranges & shapes
F & U compatible versions available

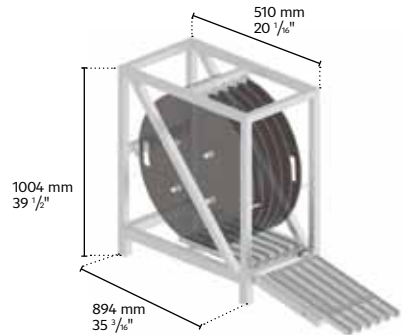

BBP800X800X6|QTB|STEEL

Series	kg	lbs
M222		
M290	29.3	(64.6)
M390		

Steel base plate with half connectors
Pre-drilled holes for multiple truss ranges & shapes
F & U compatible versions available

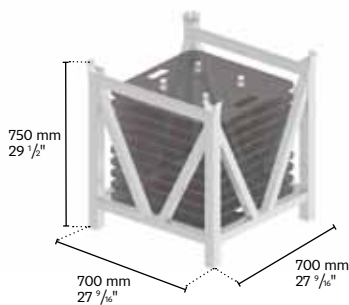

BBP1200X300|QTB|STEEL

Series	kg	lbs
M222		
M290	16.75	(36.9)
M390		

Steel base plate with half connectors
Pre-drilled holes for multiple truss ranges & shapes
F & U compatible versions available



CCO

Series	kg	lbs
M400		
M520	0.30	(0.66)
M760		
M950		

Conical connector O

CAGE-BP-M-B-K-D800

Series	kg	lbs
M222		
M390	25.00	(55.12)
M390		

Transport cage for BBPD800|QTB|STEEL
Holds up to 10 x BP-D800X10



PO|PIN

Series	kg	lbs
M400		
M520	0.12	(0.26)
M760		
M950		

Pin O

CAGE-BP-M-B-K-600X600

Series	kg	lbs
M222		
M390	18.00	(39.68)
M390		

Transport cage for BBP600X600|QTB|STEEL
Holds up to 10 x BP-600X600X10



POM12SET

Series	kg	lbs
M400	0.12 (0.26)	
M520		
M760		
M950		

Pin O with M12 thread
Supplied with washer and nylock nut.



POM12SSSET

Series	kg	lbs
M400	0.12 (0.26)	
M520		
M760		
M950		

Stainless steel Pin O with M12 thread
Supplied with washer and nylock nut.



CCOM16|MALE

Series	kg	lbs
M400	0.23 (0.51)	
M520		
M760		
M950		

Half conical connector O with M16 thread
Fixing screw not included (order separately if required).

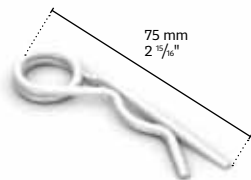

SRPO

Series	kg	lbs
M400	0.003 (0.01)	
M520		
M760		
M950		

Safety R Clip O



CS-M290/M400

Series	kg	lbs
M290	2.92 (6.44)	
M290E		
M390		
M290x390		
M400		
4GS-35		

Ceiling support - silver
SWL 1000 kg (2204 lbs) - DGVU17/BGVC1

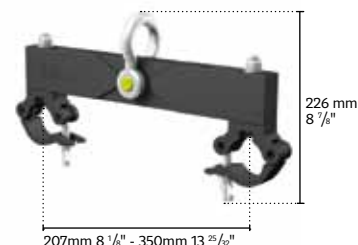

CS-M290/M400|COLOR

Series	kg	lbs
M290	2.92 (6.44)	
M290E		
M390		
M290x390		
M400		
4GS-35		

Ceiling support - black
SWL 1000 kg (2204 lbs) - DGVU17/BGVC1

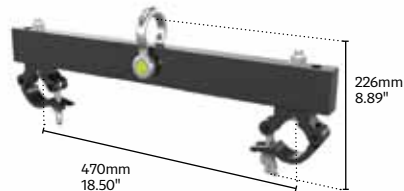

CS-M520/M760|COLOR

Series	kg	lbs
M520	9.0 (19.84)	
M760		

Ceiling support - black
SWL 1120 kg (2470 lbs) - DGVU17/BGVC1

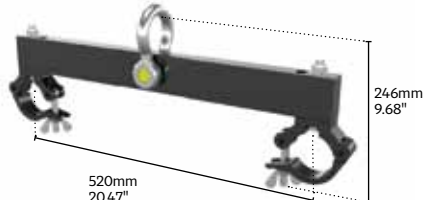

CS-M950|COLOR

Series	kg	lbs
M950	9.6 (21.16)	

Ceiling support - black
SWL 1000 kg (2204 lbs) - DGVU17/BGV C1



CON01A/B|CELL

Series	kg	lbs
M290	1.15 (2.54)	
M290E		
M390		
M290x390		

Clamp extension long
For 48 - 51 mm (1.89" - 2.01") tubes
F & U compatible versions available



CON02A/B|CELL

Series	kg	lbs
M290	1.00	(2.20)
M290E		
M390		
M290x390		

Clamp extension short
For 48 - 51 mm (1.89" - 2.01") tubes
F & U compatible versions available



CON03B|CELL

Series	kg	lbs
M290	1.08	(2.38)
M290E		
M390		
M290x390		

Clamp extension long
For 48 - 51 mm (1.89" - 2.01") tubes
F & U compatible versions available



CON04B|CELL

Series	kg	lbs
M290	0.94	(2.07)
M290E		
M390		
M290x390		

Clamp extension short
For 48 - 51 mm (1.89" - 2.01") tubes
F & U compatible versions available

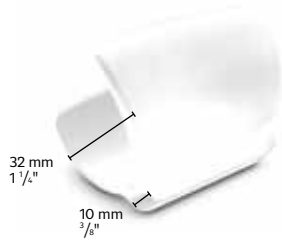

CL32|CLEAR

Series	kg	lbs
M222	0.02	(0.04)

Clip 32x
Banner attachment for $\phi=32$ mm (0.63") tubes. Colour: clear

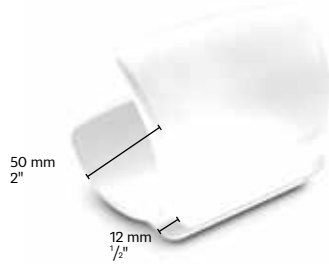

CL50|CLEAR

Series	kg	lbs
M290B	0.03	(0.07)
M290E		
M390K		
M290x390		

Clip 50
Banner attachment for $\phi=50$ mm (2") tubes. Colour: clear
Not compatible with 48 mm (1.89") tubes.

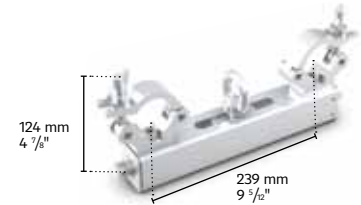

CS3B-ADJ-M290

Series	kg	lbs
M290	3.50	(7.71)
M290		
M290x390		

Ceiling support for M290 - Adjustable center of gravity
SWL 749.6 lbs (340 Kg)

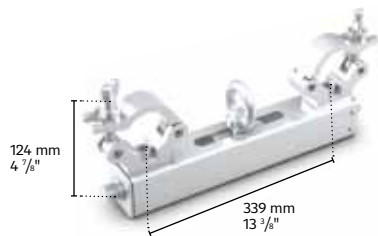

CS3B-ADJ-M390

Series	kg	lbs
M390	3.50	(7.71)

Ceiling support for M390 - Adjustable center of gravity
SWL 749.6 lbs (340 Kg)



CON64B|FEMALEPIN

Series	kg	lbs
M290	0.32	(0.71)
M390		
M290x390		

Female connector for Multicubes M290/M390 series
Supplied with washer and M12x35 bolt.
F & U compatible version available

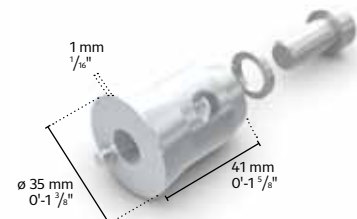

CON63B|MALEPIN

Series	kg	lbs
M290	0.17	(0.37)
M390		
M290x390		

Male connector for Multicubes M290/M390 series
Supplied with washer and M12x25 bolt.
F & U compatible version available



CON470|FEMALE

Series	kg	lbs
M400	0.50	(1.10)
M520		
M950		
M760		

Female connector for Multicubes M400/M520/M760/M950 series
Supplied with washer and M16x40 bolt.



CON16B|PARCEL DUO

Series	kg	lbs
M290	0.49	(1.08)
M390		

Connection set - DUO truss
2x CCB, 4xPB|Pin, 4x SRPB
F & U compatible versions available



CON12B|PARCEL TRIO

Series	kg	lbs
M290	0.73	(1.61)
M390		

Connection set - TRIO truss
3x CCB, 6xPB|Pin, 6x SRPB
F & U compatible versions available



CON17B|PARCEL QUATRO

Series	kg	lbs
M290	0.73	(1.61)
M390		
M290x390		

Connection set - QUATRO trussxx
4x CCB, 8xPB|Pin, 8x SRPB
F & U compatible versions available



CON60BE|PARCEL DUO

Series	kg	lbs
M290E	0.30	(0.66)

Connection set - DUO electro truss
1x CCB, 2x PB|Pin, 2x SRPB, M10x45 bolt / washer / nut



CON61BE|PARCEL TRIO

Series	kg	lbs
M290E	0.52	(1.15)

Connection set - TRIO electro truss
2x CCB, 4x PB|Pin, 4x SRPB, M12x70 bolt / washer / nut



CON420|PARCEL QUATRO

Series	kg	lbs
M400	2.16	(4.76)
M520		
M760		
M950		

Connection set - QUATRO truss
4x CCO, 8x PO|Pin, 8x SRPO



PGS|PIN|ZN

Series	kg	lbs
4GS-35	0.10	(0.22)
4GS-50		
4GS-62		

Pin GS

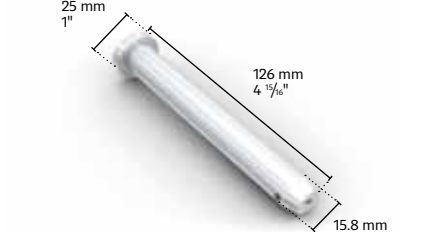

PGSF|PIN

Series	kg	lbs
4Gs-62f	0.20	(0.44)

Pin GS Folding



PGX

Series	kg	lbs
4GX-91	0.29	(0.64)

Pin GX

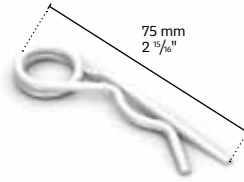

SRPO

Series	kg	lbs
4GS-35		
4GS-50		
4GS-62	0.0003	(0.01)
4GS-62F		
4GX-91		

Safety R Clip O



CON119GS|PARCELQUATRO

Series	kg	lbs
4GS-35		
4GS-50		
4GS-62	0.42	(0.93)
4GS-62F		

Connection set - QUATRO truss
4x PGS, 4x SRPO



CON133GS|PARSELFOLD

Series	kg	lbs
4GS-62F	0.42	(0.93)

Connection set - FOLD truss
2x PGS, 3x SRPO, 1x PGSF



CON139GX|PARCELQUATRO

Series	kg	lbs
4GX-91	1.15	(2.54)

Connection set - QUATRO truss
4x PGX, 4x SRPO

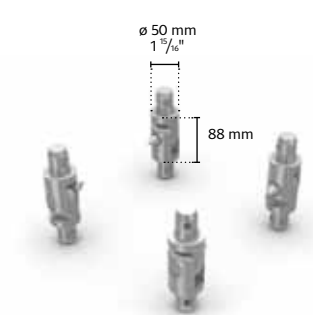

MT1-07B|HINGES|4PCS

Series	kg	lbs
M290	2.40	(5.28)
M390		

Set of 4 Hinge parts for Towers
F & U compatible versions available



CUBEB-UNI

Series	kg	lbs
M100		
M290	0.27	(0.60)
M390		
M290x390		

Multiconnection cube with 360° setting adjustability



HINGEQB-UNI

Series	kg	lbs
M100		
M290	0.27	(0.60)
M390		
M290x390		

Multiconnection hinge with 360° setting adjustability



MODULARHINGE-B

Series	kg	lbs
M100		
M290	0.49	(1.08)
M390		
M290x390		

Modular hinge solution for DUO, TRIO, QUATRO in one
Set includes 2x CON63B|MalePin
F & U compatible versions available



TRU-SLE-M290|WH TRU-SLE-M290|BL

Series	kg	lbs
M290	5.5/25m (12.13/82ft)	

Truss textile sleeve for M290 quatro
Black or white, B1 flame retardant textile
Available lengths 1.5m; 2m; 2.5m or 25m roll



BBPSC-GW

Series	kg	lbs
M100		
M290	2.00 (4.41)	
M390		
M290x390		

Transport wheel with brake and half coupler
F & U compatible versions available

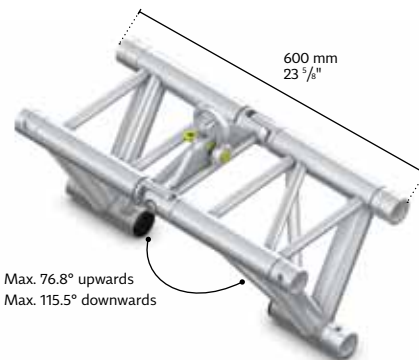

HP-STB-FLEX

Series	kg	lbs
M290	7.2 (15.87)	
M390		

Flexible Hinge Section for TRIO Truss
WLL 1000kg (2204.2 lbs)
DGVU17 / BGVC1
F & U compatible versions available

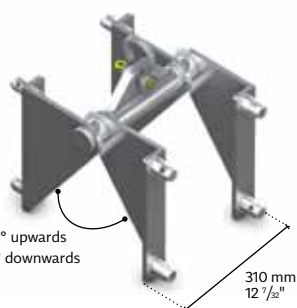

HP-QTB-FLEX

Series	kg	lbs
M290	9.7 (21.37)	
M390		

Flexible Hinge Section for QUATRO Truss
WLL 1000kg (2204.2 lbs)
DGVU17 / BGVC1
F & U compatible versions available



HANGING-PLATE-QTB

Series	kg	lbs
M290	3.5 (7.72)	

Hanging plate for M290 quatro, incl. 8x half male connector
F & U compatible versions available

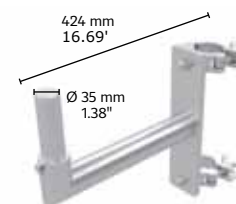

SPEAKER-MOUNT-D50

Series	kg	lbs
M100		
M290	3.10 (6.80)	
M390		

Side mounted speaker holder for 48-51mm tube
SWL = 70 kg (154 lbs)



TOP-BRACKET-QTB

Series	kg	lbs
M290	1.80 (4.00)	

M290 top bracket for lights, tube 48mm, incl. 4x half male connector
F & U compatible versions available



TOP-RING-QTB-D1000

Series	kg	lbs
M290	6.00 (13.20)	

M290 top circle, outer d=1m, tube 50mm, incl. 4x half male connector
F & U compatible versions available

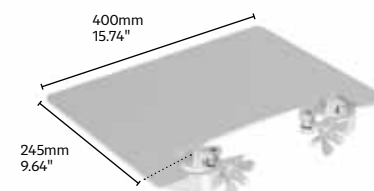

ALU-SHELF|M290

Series	kg	lbs
M290	2 (4.4)	

Aluminium shelf

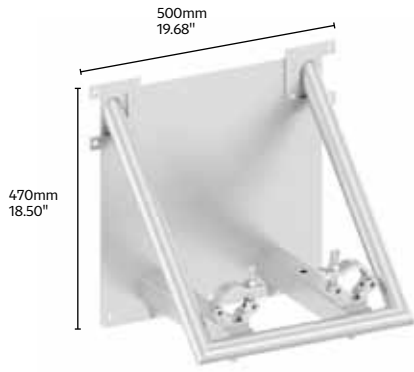

WALLPLATE-M290|500KG

Series	kg	lbs
M290	6.2	(13.7)

Truss wall mount, SWL 500 kg (1102 lbs)

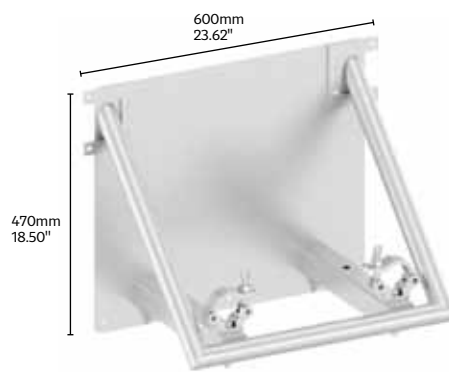

WALLPLATE-M390|500KG

Series	kg	lbs
M390	7.0	(15.4)

Truss wall mount, SWL 500 kg (1102 lbs)

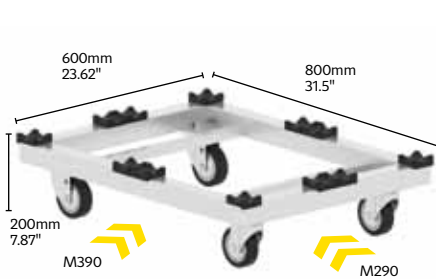

TRUSS-DOLLY

Series	kg	lbs
M290	10.1	(22.26)
M390		

Truss dolly for transport & stocking

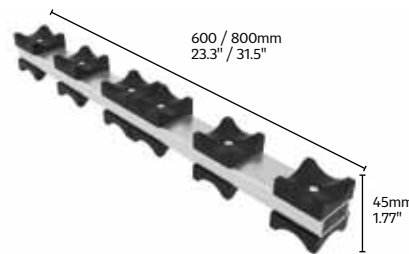

TRUSS-INSERT|M290 TRUSS-INSERT|M390

Series	kg	lbs
M290	1.3	(2.86)
M390	1.5	(3.3)

Truss insert for transport & stocking



TRA-CLI-2XD50

Series	kg	lbs
M290	0.08	(0.18)
M390		

Truss transport clip
Fits 48-51mm tubes.

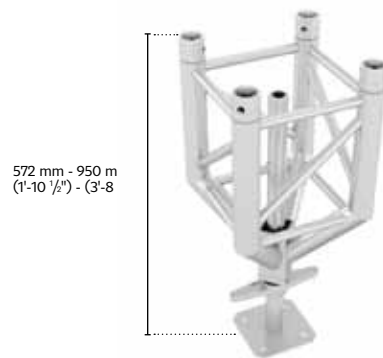

LEGM290V|572-950

Series	kg	lbs
M222	7.70	(16.97)

Adjustable pedestal leg 572-950mm
Available for M390

