

PIXAPRO®

PIKA 200 PRO

Pocket Flash



PIXAPRO® LTD.

50 Popes Lane,
Oldbury,
West Midlands,
B69 4PA

Tel: +44 (0)121 552 3113
Web: www.essentialphoto.co.uk
E-mail: customerservice@essentialphoto.co.uk

Company Registration No. 07601334

705-AD2000-00

Made in China



English

INSTRUCTION MANUAL

Foreword

Before using this product

Please read this user manual carefully in order to ensure your safety and the proper operation of this product. Keep for future reference.

Thank you for purchasing a PIXAPRO product.

TTL Powerful & Portable Flash PIKA200 Pro include three kinds of flash tube and adopts PIXAPRO 2.4G wireless ONE System. When using PIXAPRO 2.4G wireless ONE System of camera, PIKA200 Pro can be triggered by ST-III / ST-III+ / ST-IV series flash trigger in TTL/M/Muilt mode, etc. PIKA200 Pro can also use in combination with PIXAPRO TTL camera flashes, TTL outdoor flashes, TTL studio flashes, etc. With this PIKA200 Pro flash, your shooting will become simpler. You can easily achieve a correct flash exposure even in complex light-changing environments. The PIKA200 Pro is part of a portable flash system, which consists of camera flashes, wireless triggers and a range of dedicated light shaping accessories. PIKA200 Pro with lightweight and portable body, strong power, large capacity battery and full speed supply. It offers studio quality light for outdoor and live shooting. The PIKA200 Pro offers:

- **Compatible wireless TTL system:** Fully support TTL/M/Multi functions of Canon,Nikon,Sony,Fuji,Olympus, Panasonic and Pentax cameras.Workable as Slave unit in a wireless flash group.
- **Lightweight and portable:** up to 200Ws, is to 3 times powerful as camera flashes (600EX), and the size almost the same.
- **Changeable flash head: Speedlite flash head:** Portability, comes with multiple sets of optical glass, even illumination and modeling lamp (LED. **Bare bulb flash head:** Lighting out with 360 degree angles, all lighting accessories fit for barebulb flashes from most brands.
- **High-quality AV panel:** with clear and convenient operation.
- **Built-in 2.4G wireless transmission:** with all-in-one functions and 100 meters further transmission
- **Studio quality light:** up to 200Ws, GN 60 (m ISO 100, with bare bulb flash head/ GN52 (Speedlite flash head
- **Battery pack:** Large-capacity power supply (lithium, 14.4V/2900mAh 0.01- 1.8s recycling and 500 full power flashes.
- **Wireless control:** With built-in PIXAPRO 2.4G wireless ONE System to achieve TTL control. PIXAPRO PRO AC flash trigger can also be used to wirelessly adjust flash power level and trigger the flash. PIKA200 Pro has 3.5mm sync cord jack to achieve various sync triggering mode.
- **Power adjusts from full power to 1/256 in 81 levels.**
- **Change within ± 100K over the entire power range in color temperature mode.**
- **1/8000s high-speed sync flash, high-speed sync triggering.**



The powerful and portable PIKA200 Pro meets the demands of freelance commercial photographers, photojournalists, wedding and beach portraiture shooters, event and backpack photographers, photograph enthusiasts, etc.

Warning



- ▲ Always keep this product dry. Do not use in rain or in damp conditions.
- ▲ Do not disassemble. Should repairs become necessary, this product must be sent to an authorized maintenance center.
- ▲ Keep out of reach of children.
- ▲ Stop using this product if it breaks open due to extrusion, falling or strong hit. Otherwise, electric shock may occur if you touch the electronic parts inside it.
- ▲ Do not fire the flash directly into the eyes (especially those of babies) within short distances. Otherwise visual impairment may occur.
- ▲ Do not use the flash unit in the presence of flammable gases, chemicals and other similar materials. In certain circumstance, these materials may be sensitive to the strong light emitting from this flash unit and fire or electromagnetic interference may result.
- ▲ Do not leave or store the flash unit if the ambient temperature reads over 50°C. Otherwise the electronic parts may be damaged.
Turn off the flash unit immediately in the event of malfunction.



Contents

01	Foreword
02	Warning
05	Name of Parts
	Body
	Flash Head
	AV Panel
	Included Accessories
	Separately Sold Accessories
	Attaching Bare bulb flash head
09	Battery
10	Power Management
10	Modeling Lamp
10	Wireless Flash Mode
11	Flash Mode— TTL Autoflash
	TTL Mode
	 FEC (Flash Exposure Compensation)
	 High-Speed Sync
12	Flash Mode—M: Manual Flash
14	Flash Mode—Multi/Stroboscopic Flash
15	Wireless Flash Shooting: Ratio (2.4G) Transmission
19	C.Fn: Setting Custom Functions
18	Other Applications
	Wireless Control Function
	Sync Triggering
18	Protection Function
20	Technical Data
21	Troubleshooting
21	Firmware Upgrade
21	Maintenance

Conventions used in this Manual

- This manual is based on the assumption that both the camera and camera flash's power switches are powered on.
- Reference page numbers are indicated by "p.**".
- The following alert symbols are used in this manual:
 -  The Caution symbol indicates a warning to prevent shooting problem.
 -  The Note symbol gives supplemental information.

Name of Parts

Body:

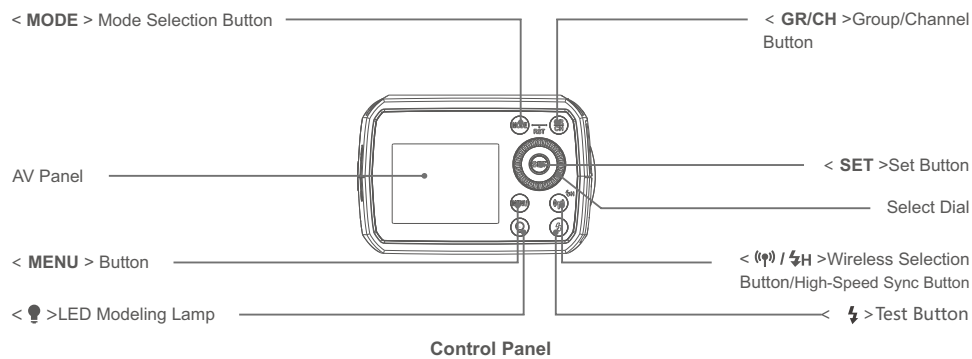
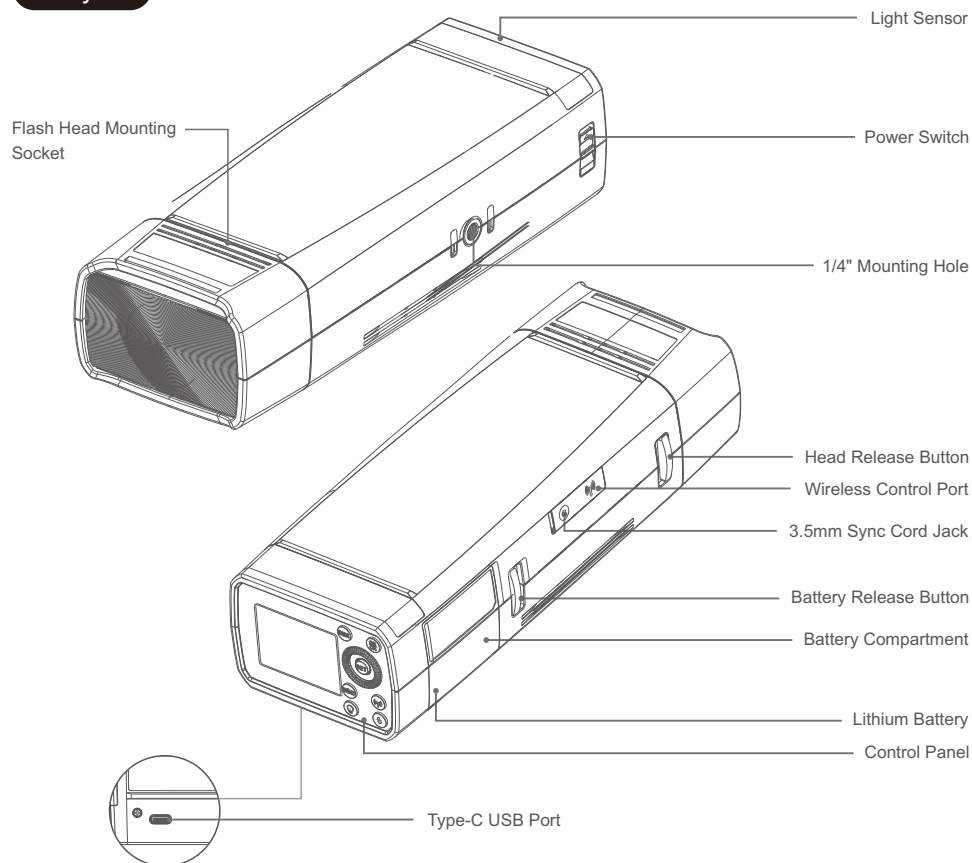

Name of Parts

Flash Head:

Speedlite flash head:



Bare bulb flash head:



Name of Parts

AV Panel

(1) AV Panel

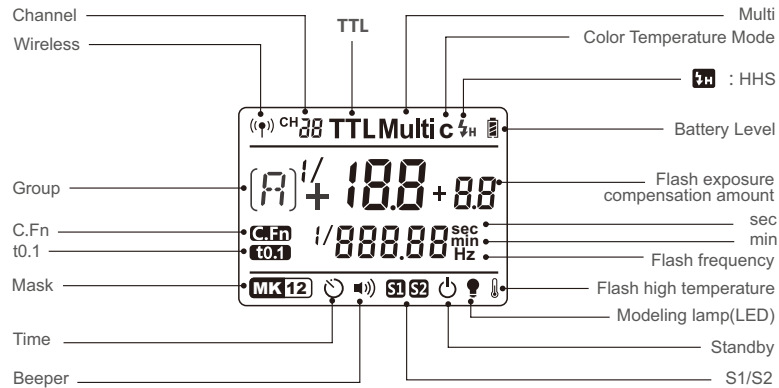

- The display will only show the settings currently applied.
- The functions displayed above function buttons 1 to 4, such as **SYNC** and **±**, change according to settings' status.
- When a button or dial is operated, the AV panel illuminated.

(2) M Manual Flash

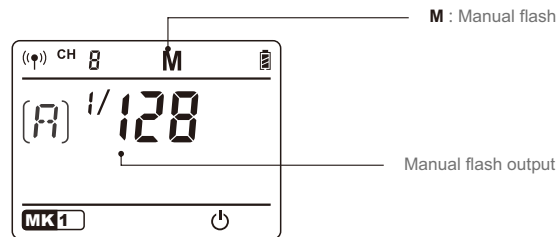

(3) Multi Flash

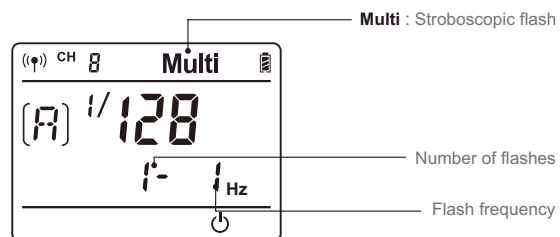

Name of Parts

(4) Radio Transmission Shooting

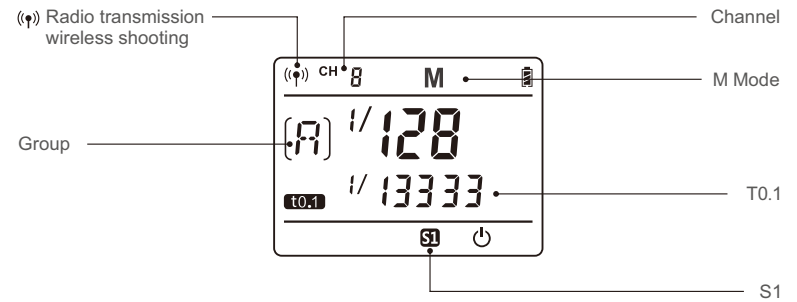

• S1/S2

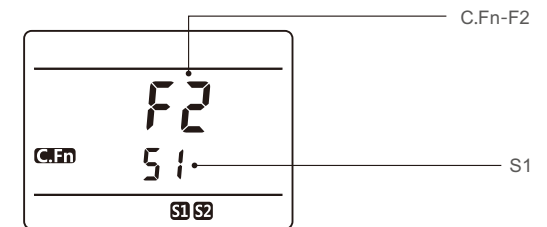

Included Accessories

- (1) Speedlite flash head
- (2) Bare bulb flash head
- (3) 1x Tilt-bracket
- (4) 1x Battery charger
- (5) 1x Lithium battery pack
- (6) 1x Carry Case
- (7) 1x Instruction manual

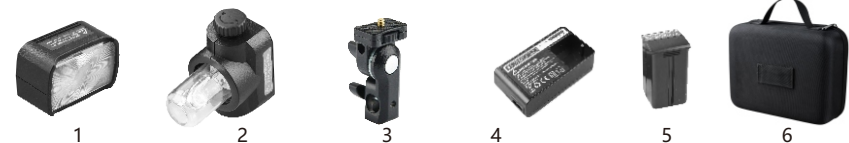

Separately Sold Accessories

The product can be used in combination with the following accessories sold separately, so as to achieve best photography effects: ST-IV & ST-III Wireless Flash Trigger, PIKA200 Round Head, PRO AC Remote Control, Barn door with 4 flags, Softbox, Beauty Dish, Fold up umbrella, Snoots, Light stand, etc.



Name of Parts

Attaching Bare bulb flash head

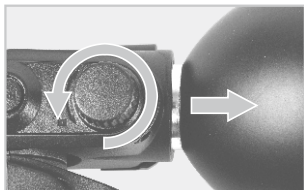

1. Remove the reflector or other accessories from the flash head.

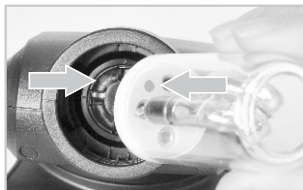

2. Match the red dot on the base of the flash tube with the red dot in the Tube Socket (4). Push the flash tube in until it is securely seated into the socket.

Lithium Battery

Features

1. This flash unit uses Li-ion polymer battery which has long runtime. The available charge-and-discharge times are 500.
2. It is reliably safe. The inner circuit is against overcharge, overdischarge, overcurrent, and short circuit.
3. Take only 4 hours to fully charge the battery by using the standard battery charger.

Cautions:

- Do not short circuit.
- Do not expose to rain or immerse into water. This battery is not water proof.
- Keep out of reach of children.
- No over 24 hours' continuous charging.
- Store in dry, cool, ventilated places.
- Do not put aside or into fire.
- Dead batteries should be disposed according to local regulations.
- Long time not to use, please charge it to 60% and then placed.
- If the battery had ceased using for over 3 months, please make a full recharge.

Battery Level Indication

Make sure the battery pack is securely loaded in the flash. Check the battery level indication on the AV panel to see the remaining battery level.

Battery Level Indication on the AV Panel	Meaning
3 grids	Full battery
2 grids	Medium battery
1 grid	Low battery
Blank grid	Lower battery, please recharge it.
Blinking	The battery level is going to be used out immediately. And the flash will auto power off in 1 minute. Note: Please recharge the battery as soon as possible (within 10 days). Then, the battery can be used or be placed for long period.

Power Management

ON/OFF Power Switch controls the on/off of the flash unit, turn off the power pack if the flash unit will not be used for an extended period. The product design of power supply with automatic hibernation feature, When unattended operation for a long time (approx. 30/60/90 minutes), the flash will automatically standby.

 **C.Fn** Disabling Auto Power standby function is recommended when the flash is used off camera. (C.Fn-F3, Page 17)

Modeling Lamp

With only the speedlite flash head have modeling lamp function, it will automatic turn off after 30 minutes. Short press the modeling lamp button will control the modeling lamp turn on or off.

Wireless Flash Mode

PIKA200 Pro can only be set as slave unit (receiver end). Short press the wireless selection button to switch the radio transmission function.

Wireless Mode	Flash Mode
OFF	M / Multi
Radio Transmission	TTL / M / Multi

Flash Mode — TTL Autoflash

This flash has three flash modes: TTL, Manual (M), and Multi (Stroboscopic). In TTL mode, the camera and the flash will work together to calculate the correct exposure for the subject and the background. In this mode, multiple TTL functions are available: FEC, FEB, FEL, HSS, second curtain sync, modeling flash, control with the camera's menu screen.

* Press <MODE> Mode Selection Button and three flash modes will display on the AV panel one by one with each pressing.

TTL Mode

Press <MODE> Mode Selection Button to enter TTL mode. The AV panel is displayed <TTL>.

FEC: Flash Exposure Compensation

With FEC function, this flash can adjust from -3 to +3 in 1/3rd stops. It is useful in situations where minor adjusting of the TTL system is needed based on the environment.

Setting FEC:

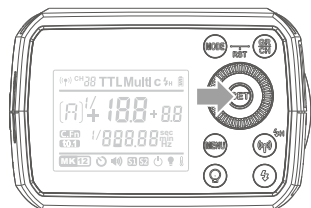

- 1 Press the <SET> Function Button and flash exposure compensation amount will be highlighted on the AV panel.

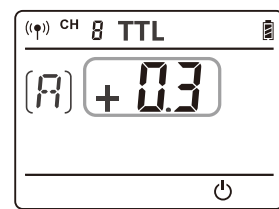

- 2 Set the flash exposure compensation amount.
 - Turn the Select Dial to set the amount.
 - "0.3" means 1/3 step,
 - "0.7" means 2/3 step.
 - To cancel the flash exposure compensation, set the amount to "+0".

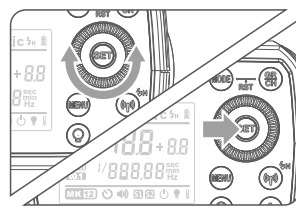

- 3 Press <SET> button again to confirm the setting.

High-Speed Sync

High Speed Sync (FP flash) enables the flash to synchronize with all camera shutter speeds. This is convenient when you want to use aperture priority for fill-flash portraits.

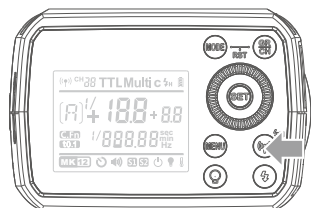

- 1 Long Press Function Button < * / FH > for 2 seconds so that < FH > is displayed.

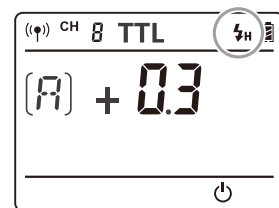

- 2 Please use the ST-III series transmitter to trigger.

- With high-speed sync, the faster the shutter speed, the shorter the effective flash range.
- Multi flash mode cannot be set in high-speed sync mode.
- Over-temperature protection may be activated after 20 consecutive high-speed sync flashes.

Flash Mode — M: Manual Flash

The flash output is adjustable from 1/1 full power to 1/256th power in 1/10th stop increments. To obtain a correct flash exposure, use a hand-held flash meter to determine the required flash output.

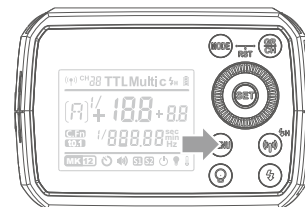

- 1 Press <MODE> button so that < M > is displayed.

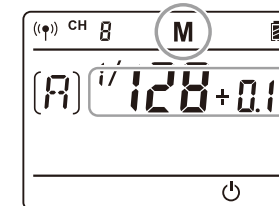

- 2 Turn the Select Dial to choose a desired flash output amount.

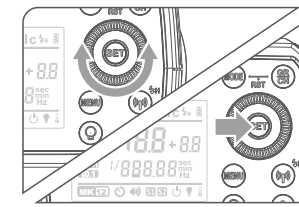

- 3 Press <SET> button again to confirm the setting.

Optic S1 Secondary Unit Setting

In M manual flash mode, press the <MENU> button to enter C.FN-F2 to choose S1 function, so that this flash can function as an optic S1 secondary flash with optic sensor. With this function, the flash will fire synchronously when the main flash fires, the same effect as that by the use of radio triggers. This helps create multiple lighting effects.

Optic S2 Secondary Unit Setting

Press the <MENU> button to enter C.FN-F2 to choose S2 function, so that this flash can also function as an optic S2 secondary flash with optic sensor in M manual flash mode. This is useful when cameras have pre-flash function. With this function, the flash will ignore a single "pre-flash" from the main flash and will only fire in response to the second, actual flash from the main unit.

• S1 and S2 optic triggering is only available in M manual flash mode.

Display Flash Duration

Flash duration refers to the length of time that from flash's firing to reach the half peak at maximum. The half peak at maximum is usually expressed as $t=0.5$. In order to provide the photographer with more concrete data, this product adopts $t=0.1$. The difference between $t=0.5$ and $t=0.1$ is shown in the following picture.

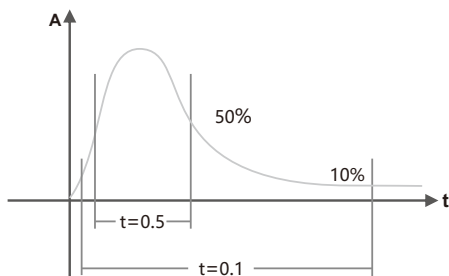

Display Flash Duration Operation :

1. Press the <MENU> button to enter C.FN function.
2. Adjust the Select Dial to F6, the $t0.1$ icon will be displayed on the AV panel.
3. Press <SET> button to enter the adjustment condition.
4. Turn the Select Dial to choose the ON/OFF.

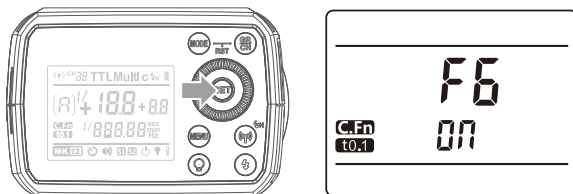

• The flash duration will only be displayed on the AV panel in M mode.

Stable Color Temperature Function

When use this function, the color temperature changes within $\pm 100K$ over the entire power range: enter MENU C.Fn-08 and set it as ON, which means the color temperature function is turned on. When adjusting the power output from high to low in M mode, Flash Ready Indicator will blink (the beeper will alarm for 1 minute). Now press the Test Button to discharge, and the flash can be used as normal.

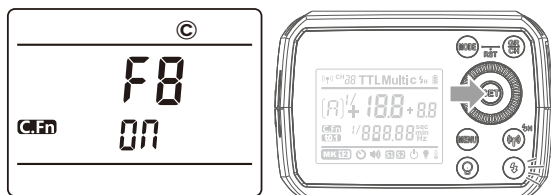

• This function can only be supported in M non-high-speed mode.

Flash Mode — Multi: Stroboscopic Flash

With stroboscopic flash, a rapid series of flashes is fired. It can be used to capture a multiple images of a moving subject in a single photograph.

You can set the firing frequency (number of flashes per sec. expressed as Hz), the number of flashes, and the flash output.

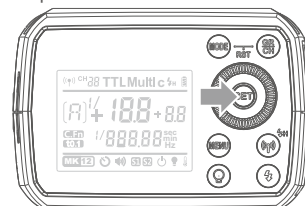

1 Press <MODE> button so that <MULTI> is displayed.

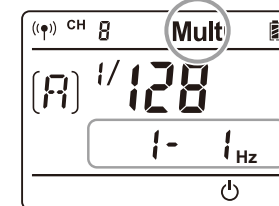

2 Turn the Select Dial to choose a desired flash output.

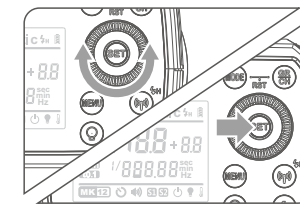

3 Set the flash frequency and flash times.

- Press <SET> button to select the flash frequency. Turn the Select Dial to set the number.
- Press <SET> button to select the flash times. Turn the Select Dial to set the number.
- After finish the setting, press <SET> button and all the settings will be displayed.

Calculating the Shutter Speed

During stroboscopic flash, the shutter remains open until the firing stops. Use the formula below to calculate the shutter speed and set it with the camera.

Number of Flashes / Flash Frequency = Shutter Speed

For example, if the number of flashes is 10 and the firing frequency is 5 Hz, the shutter speed should be at least 2 seconds.

⚠ To avoid overheating and deteriorating the flash head, do not use stroboscopic flash more than 10 times in succession. After 10 times, allow the camera flash to rest for at least 15 minutes. If you try to use the stroboscopic flash more than 10 times in succession, the firing might stop automatically to protect the flash head. If this happens, allow at least 15 minutes' rest for the camera flash.

- Stroboscopic flash is most effective with a highly reflective subject against a dark background.
- Using a tripod and a remote control is recommended.
- A flash output of 1/1 and 1/2 cannot be set for stroboscopic flash.
- Stroboscopic flash can be used with "buLb".
- If the number of flashes is displayed as "--", the firing will continue until the shutter closes or the battery is exhausted. The number of flashes will be limited as shown by the following table.

Maximum Stroboscopic Flashes:

Flash Output \ Hz	1	2	3	4	5	6-7	8-9	10	11	12-14	15-19	20-50	60-99
1/4	7	6	5	4	4	3	3	2	2	2	2	2	2
1/8	14	14	12	10	8	6	5	4	4	4	4	4	4
1/16	30	30	30	20	20	20	10	8	8	8	8	8	8
1/32	60	60	60	50	50	40	30	20	20	20	18	16	12
1/64	90	90	90	80	80	70	60	50	40	40	35	30	20
1/128 1/256	90	90	90	90	90	90	80	70	70	60	50	40	40

Wireless Flash Shooting

PIKA200 Pro adopts PIXAPRO 2.4G wireless ONE System, which has good compatibility with other products of our company. As a slave unit, PIKA200 Pro is automatically compatible with Canon/ Nikon/ Sony TTL system according to the master unit. Nikon cameras (use ST-III-N), Canon cameras (use ST-III-C) and Sony cameras (use ST-III-S) can use one or more PIKA200 Pro-TTL flashes simultaneously.

1. Wireless Settings

Press the wireless selection button to switch wireless function ON/ OFF.
Turn the wireless function on, the <((☑))> icon will be displayed on the AV panel.
When using the PRO AC remote control or others trigger, please turn off the wireless function.

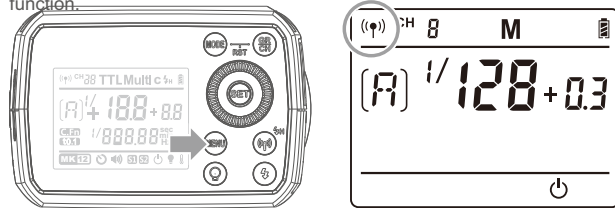

2. Setting the Communication Channel

If there are other wireless flash systems nearby, you can change the channel IDs to prevent signal interference. The channel IDs of the master unit and the slave unit(s) must be set to the same.

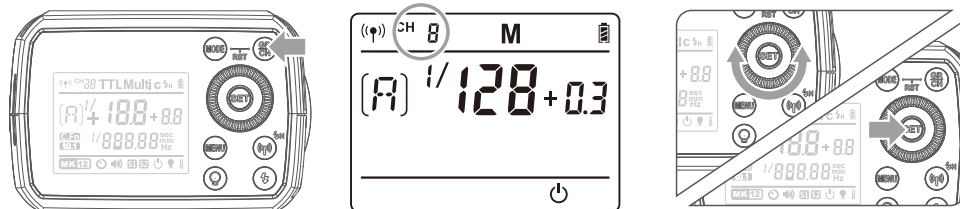

1 Long press the <GR/CH> Button for 2 seconds, so that the icon will be displayed on the AV panel.

2 Turn the Select Dial to choose a channel ID from 1 to 32.

3 Press the <SET> button to confirm.

3. Setting the Communication Group

Short press the < GR/CH > button to choose group ID from A to E.

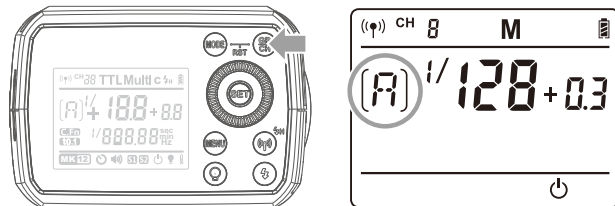

4. Wireless ID Settings

Press the MENU button to enter C.Fn to choose OFF or any figure from 01-99.
Note: This can only be used when the master unit possesses the wireless ID function.

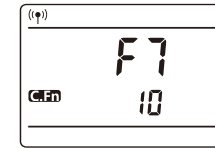

Positioning and Operation Range
(Example of wireless flash shooting)

- Autoflash Shooting with One Slave Unit

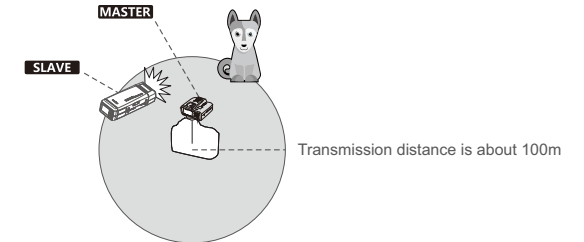

- Use the supplied stand to position the slave unit.
- Before shooting, perform a test flash and test shooting.
- The transmission distance might be shorter depending on the conditions such as positioning of slave units, the surrounding environment and whether conditions.
- With a lot of wireless signal interference conditions, if you miss flash, please change the wireless communication channel.

Wireless Multiple Flash Shooting

You can divide the slave units into two or three groups and perform TTL autoflash while changing the flash ratio (factor). In addition, you can set and shoot with a different flash mode for each firing group, for up to 5 groups.

- Auto Shooting with Two Slave Groups

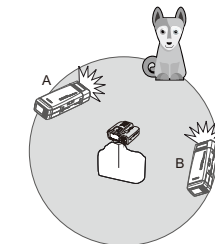

- Auto Shooting with Three Slave Groups

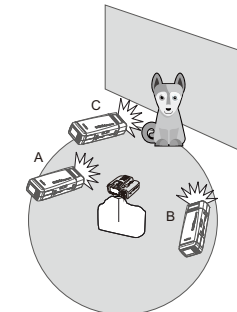

- When using the PIKA200 Pro and PIXAPRO ST-III series trigger together the ST-III can control the flash function as such
 - Flash Mode: TTL, M, Multi
 - Sync Mode: First-curtain sync, second-curtain sync and High-speed sync
 - Control the power level
 - Modeling Lamp turn on or off
 - Beeper turn on or off

C.Fn: Setting Custom Functions

The following table lists the available and unavailable custom functions of this flash.

Custom Function Signs	Functions	Setting Signs	Settings & Descriptions	Restrictions
F1	Beeper	ON	ON	NO
		OFF	OFF	
F2	S1/S2 mode selection	OFF	OFF	M mode
		S1	S1 mode	
		S2	S2 mode	
F3	Auto standby	OFF	OFF	NO
		30 min	Auto standby	
		60 min	without	
		90 min	any operation	
F4	Delay flash	OFF, 0.01~30s	Can be triggered as second curtain	M/Multi mode
F5	Mask	OFF	OFF	M mode
		N1	ON: Trigger 2 times for 1 cycles, 1th flash of trigger.	
		N2	ON: Trigger 2 times for 1 cycles, 2th flash of trigger.	
F6	t0.1 display	ON	Display	M mode
		OFF	Not display	
F7	ID Setting	OFF	OFF	Wireless mode
		01-99	Choose any figure from 01-99	
F8	Stable Color	OFF	OFF	M non-high-speed mode
	Temperature Mode	ON	ON	

- Press the **< MENU >** button to enter the C.Fn menu.
- Select the custom function No.
 - Turn the Selection Dial to select the custom function No.
- Change the setting
 - Press **< SET >** button and the Setting No. blinks.
 - Turn the Select Dial to set the desired number. Press **< SET >** button will confirm the settings.
- Exit C.Fn menu
 - Press **< MENU >** button to exit.

Other Applications

Wireless Control Function

The flash unit is built in with a Wireless Control Port so that you can wirelessly adjust the power level of the flash and the flash triggering. To control the flash wirelessly, you need a PRO AC remote control set (on-camera and on-flash). Insert its receive end into the Wireless Control Port on the flash and insert the transmit end into the camera hot shoe. Settings made on the hotshoe-mounted transmit and receive ends will be wirelessly communicated to the flash. Then you can press the camera shutter release button to trigger the flash. You can also hold the transmit end at hand to control your off-camera flash.

- For full instructions on the use of PRO AC series remote control, see its user manual.
- Turn off the PIKA200 Pro wireless function.

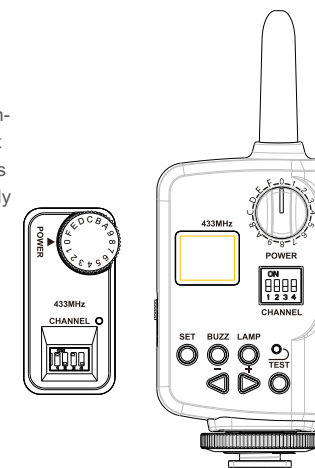

Sync Triggering

The Sync Cord Jack is a $\Phi 3.5\text{mm}$ plug. Insert a trigger plug here and the flash will be fired synchronously with the camera shutter.

Protection Function

1. Over-Temperature Protection

- To avoid overheating and deteriorating the flash head, do not fire more than 40 continuous flashes in fast succession at 1/1 full power. After 40 continuous flashes, allow a rest time of at least 10 minutes.
 - If you fire more than 40 continuous flashes and then fire more flashes in short intervals, the inner over-temperature protection function may be activated and make the recycling time over 10 seconds. If this occurs, allow a rest time of about 10 minutes, and the flash unit will then return to normal.
 - When the over-temperature protection is started,  is shown on the AV display.
- Number of flashes that will activate over-temperature protection:**

Power Output Level	Number of Flashes	
	Speedlite flash head	Bare bulb flash head
1/1	40	60
1/2+0.7	50	80
1/2+0.3	60	100
1/2	75	120
1/4(+0.3,+0.7)	100	150
1/8(+0.3,+0.7)	200	200
1/16(+0.3,+0.7)	300	300
1/32(+0.3,+0.7)	500	500
1/64(+0.3,+0.7)	1000	1000
1/128(+0.3,+0.7)		
1/256(+0.3,+0.7)		

Number of flashes that will activate over-temperature protection in high-speed sync triggering mode:

Power Output	Times	
	Speedlite flash head	Bare bulb flash head
1/1	20	50
1/2(+0.3,+0.7);	30	60
1/4(+0.3,+0.7);	50	75
1/8(+0.3,+0.7);	75	100
1/16(+0.3,+0.7)	80	150
1/32(+0.3,+0.7)	100	200
1/64(+0.3,+0.7);		
1/128(+0.3,+0.7);		
1/256(+0.3,+0.7)		

2. Other Protections

- The system provides real-time protection to secure the device and your safety. The following lists prompts for your reference:

Prompts on LCD Panel	Meaning
E1	A failure occurs on the recycling system so that the flash cannot fire. Please restart the flash unit. If the problem still exists, please send this product to a maintenance center.
E2	The system gets excessive heat. Please allow a rest time of 10 minutes.
E3	The voltage on two outlets of the flash tube is too high. Please send this product to a maintenance center.
E9	There are some errors occurred during the upgrading process. Please using the correct firmware upgrade method.

Technical Data

Model	PIKA200 Pro	
Wireless Slave Unit Mode	Radio transmission mode (compatible with Nikon, Canon, Sony, Fujifilm, Olympus, Panasonic & Pentax)	
Flash Mode	Wireless off	M/Multi
	Slave unit of radio transmission	TTL/ M/Multi
Compatible Cameras under Radio Transmission (as slave unit)	Nikon cameras (ST-III-N as master unit)	
	Canon EOS cameras (ST-III-C as master unit)	
	Sony cameras (ST-III-S as master unit)	
	Fujifilm cameras(ST-III-F as master unit)	
Guide No. (1/1 Output)	Speedlite flash head: 52 (m ISO 100, @35mm)	
	Bare bulb flash head: 60 (m ISO 100, with the AD-S2 standard reflector, @28mm)	
Flash Duration t.01 (approx.)	Speedlite flash head: 1/220 to 1/15380 seconds	
	Bare bulb flash head: 1/220 to 1/13510 seconds	
POWER	200W	
Power Output	9 steps: 1/256~1/1	
Stroboscopic Flash	Provided (up to 90 times, 99Hz)	
Flash Exposure Compensation (FEC)	Manual. FEB: ±3 stops in 1/3 stop increments.	
Sync mode	High-speed sync (up to 1/8000 seconds), first-curtain sync, and second-curtain sync	
Delay Flash	0.01~30 seconds	
Mask	√	
Beeper	√	
Modeling Lamp (LED)	√	
Optic Slave Flash	S1/S2	
Flash Duration Indication	√	
Wireless Flash (2.4G transmission)		
Wireless flash function	Slave, Off	
Controllable slave groups	5 (A, B, C, D, and E)	
Transmission range (approx.)	100m	
Channels	32 (1~32)	
ID	01~99	
Power Supply		
Power Supply	Lithium battery pack (14.4V/2900mAh)	
Full Power Flashes	500	
Recycle Time	Approx. 0.01-1.8s	
Battery Indicator	√	
Power Indication	Change within ±100K over the entire power range in color temperature mode.	
Sync Triggering Mode	Power standby automatically after approx. 30 minutes of idle operation.	
Color Temperature	3.5mm sync line, Wireless control port	
Stable Color Temperature	5600±200k	
Dimensions		
Dimension	172x54x75mm (flash head not included)	
Net Weight	590g (flash head & battery not included)	

Firmware Upgrade

- USB connection line is not included in this product. The USB port is a Type-C USB socket. Type-C USB connection line is applicable.
- As the firmware upgrade needs the support of PIXAPRO G3 software, please download and install the "PIXAPRO G3 firmware upgrade software" before upgrading. Then, choose the related firmware file.
- As the product needs to do firmware upgrade, please refer to instruction manual of the newest electric version as final.

Maintenance

- Shut down the device immediately should abnormal operation be detected.
- Avoid sudden impacts and the product should be dedusted regularly.
- It is normal for the flash tube to be warm when in use. Avoid continuous flashes if unnecessary.
- Maintenance of the flash must be performed by our authorized maintenance department which can provide original accessories.
- This product, except consumables e.g. flash tube, is supported with a one-year warranty.
- Unauthorized service will void the warranty.
- If the product had failures or was wetted, do not use it until it is repaired by professionals.
- Changes made to the specifications or designs may not be reflected in this manual.