

Godox

变焦双色温LED摄影灯  
Zoom Bi-color LED Video Light

SZ200Bi

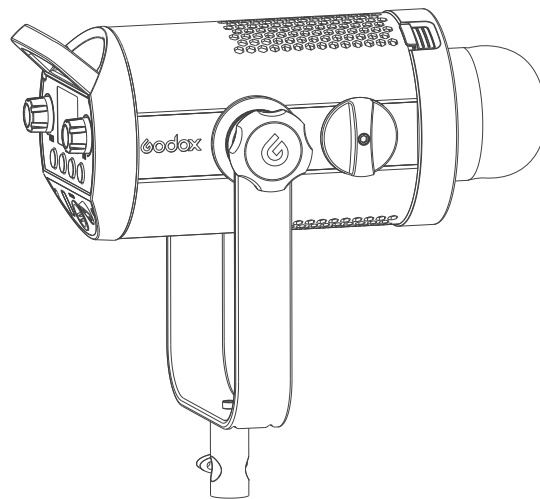

**深圳市神牛摄影器材有限公司**

地址: 深圳市宝安区福海街道塘尾社区福川工业区厂房2栋  
电话: 0755-29609320(8062) 传真: 0755-25723423 邮箱: godox@godox.com

**GODOX Photo Equipment Co., Ltd.**

Add: Building 2, Yaochuan Industrial Zone, Tangwei Community, Fuhai Street, Bao'an District,  
Shenzhen, China Tel: +86-755-29609320(8062) Fax: +86-755-25723423 E-mail: godox@godox.com

godox.com

Made in China



使用手册  
Instruction Manual

# 前言

感谢您购买神牛产品！

变焦双色温LED摄影灯SZ200Bi是一款多功能常亮灯，适用于任何场景：直播、野外露营、自拍、静物拍摄、化妆照明、视频录制、婚纱摄影、儿童拍摄等。多种遥控方式，操作便捷。

## 主要特点：

- 一灯多用，随心切换LED双色温模式和22种情景光效模式
- 自由调节色温和亮度
- 多灯联控，手机APP/2.4G无线/DMX控制台智能遥控
- 静音模式：零噪音，无干扰
- 强光模式：功率可达最大
- 彩屏清晰显示
- 优秀的的散热系统

## 警告

- △ 请保持干燥：请勿用湿手接触产品，亦不可将产品浸入水中或暴露于雨中。
- △ 请勿私自拆卸产品，如产品出现故障须由本公司或授权的维修人员进行检查维修。
- △ 请勿让儿童接触本产品。
- △ 本产品不能防水，在雨天及潮湿环境下请注意防水。
- △ 设备工作时会有发热现象，请小心触摸！

# 部件名称

## • 灯体

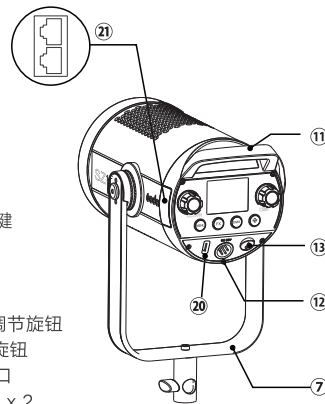
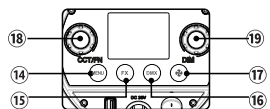
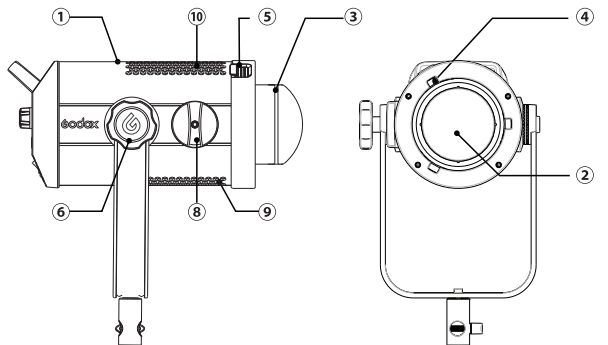

- |            |                |
|------------|----------------|
| 01. 灯体     | 12. 电源插座       |
| 02. LED灯珠  | 13. 船形开关       |
| 03. 灯珠保护罩  | 14. MENU按键     |
| 04. 保荣卡口   | 15. FX按键       |
| 05. 卡口固定拨扭 | 16. DMX按键      |
| 06. 支架旋扭   | 17. 风扇按键       |
| 07. U型支架   | 18. CCT/FN调节旋钮 |
| 08. 调焦机械旋钮 | 19. DIM调节旋钮    |
| 09. 散热口1   | 20. USB升级口     |
| 10. 散热口2   | 21. RJ45接口 x 2 |
| 11. 把手     |                |

# 显示屏

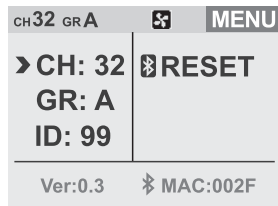

## • MENU界面

1. CH通道
2. GR组别
3. 2.4G无线ID号
4. 蓝牙密码重置功能
5. V0.3(版本号)
6. MAC (蓝牙号)

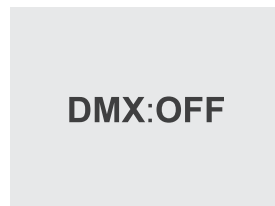

## • DMX界面

1. DMX通道号显示 (OFF/1~512)

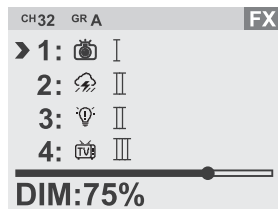

## • FX界面

1. 1~8类特效不同功能显示
2. DIM: 亮度显示

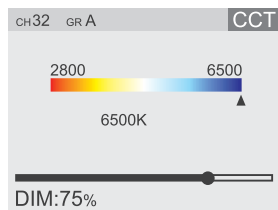

## • CCT界面

1. 2800K~6500K: 色温
2. DIM: 亮度显示

## 标配物品

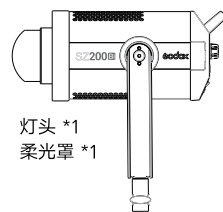

灯头 \*1  
柔光罩 \*1

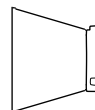

反光罩 \*1



灯头保护盖 \*1



钢丝绳 \*1



背夹扣 \*1



适配器 \*1



电源线 \*1



适配器固定座 \*1



说明书 \*1

## 可选购附件

可搭配本公司以下摄影附件使用，以获得最佳的拍摄效果和使用体验：  
RC-A6遥控器、逆变器、柔光箱、反光伞、灯架、蜂巢、雷达罩、束光筒等

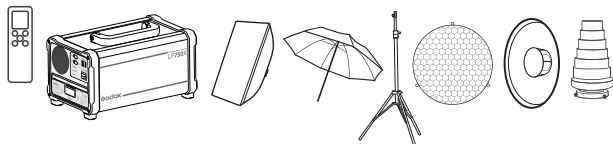

## 接通电源

通过电源线接通适配器，拨动LED灯上的电源开关。

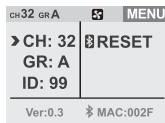
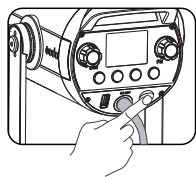

## 操作说明

### • MENU按键

LED灯进入菜单界面可以设置CH通道 (1~32), GR组别 (A/B/C/D/E/F,0-9), ID (OFF/01~99), 蓝牙 (RESET) 等功能。

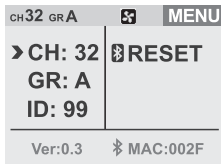

### • FX按键

短按一次FX按键，进入FX模式界面进行设置；  
旋转CCT/FN旋钮，可选择光效模式类别，有1~8类可选；选中后短按CCT/FN旋钮可切换类别中的模式：I、II、III 3种模式。

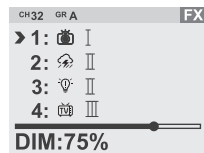

情景光效模式有8类共22种：可根据需求选择。

序号	显示	场景	显示 I	显示 II	显示 III
1		闪光灯	闪光	发布会	狗仔队
2		雷闪电	间歇	频繁	持续
3		坏灯泡	间歇	频繁	持续
4		电视机	慢速	中速	快速
5		蜡烛	间歇	频繁	持续
6		火	柴火	篝火	火灾
7		烟花	短暂	连续	演出
8	SOS	SOS			

### • DMX按键

短按DMX按键进入设置界面，可以设置DMX频道编号 (OFF/001~512),通过RJ45口连接控制台，控制台就可以控制SZ系列的LED灯参数。

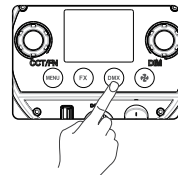

### • 色温调节

开机默认进入CCT色温调节界面，旋转CCT/FX旋钮，可以进行色温调节 (2800K~6500K)。

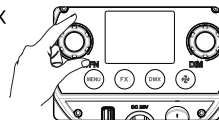

### • 亮度调节

在FX界面或者CCT界面，直接旋转DIM旋钮，可以进行LED灯亮度调节(0%~100%)。按一次DIM旋钮可关闭亮度，再按一次可恢复关闭前设置的亮度。

注：在开机状态下，在任何界面，按一次DIM旋钮都可以实现LED灯亮度快速关闭或打开功能。

### • 风扇按键

短按风扇按键可以控制LED灯的风扇开关：

1. 不打开风扇时为静音模式，静音模式零噪音，无干扰，亮度为0%~35%。
2. 打开风扇，LED灯可以设置强光模式，强光模式时功率达到最大。

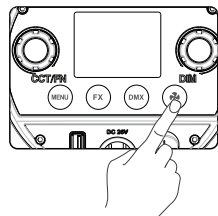

### • 调焦机械旋钮

手动调节可实现照射角度从20°~65°改变。

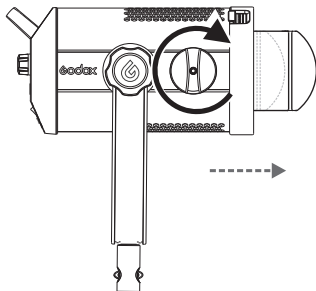

### • USB升级口

1. 在官网<http://www.godox.com.cn/Downloads.html>下载新固件到U盘上。
2. 在关机的状态下，将已经存有新固件的U盘插入USB升级接口。
3. 开机，LED灯自动进入升级界面。
4. 升级完后自动跳回主界面。

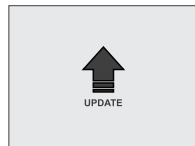
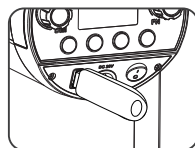

- 注：1. 必须官网下载新固件存放在U盘根目录，而且只有一个BIN文件。  
2. USB口仅用于升级固件功能。

# 控制模式选择

## 1. DMX控制设置

在MENU界面选择DMX选项，可以设置DMX频道编号(OFF/001~512)，通过RJ45口连接控制台，控制台就可以控制SZ系列的LED灯参数。

DMX:OFF

运行模式	CCT	FX	备注
通道			
n	0-51	52-255	1、DMX表示在中控台上设置的值。 2、n表示DMX的通道号。 3、两台机的通道不能重叠。
n+1	DMX*(100/255) 取整数 0-100%亮度调节	DMX*(100/255)取整数 0-100%亮度调节	
n+2	DMX*(最高色温-最低色温)/100/255 (取整数)	DMX*(光效总数/255)	
n+3		0-85: I 86-171: II 172-255: III	

## 2. 2.4G无线控制

SZ200Bi LED灯具备无线遥控功能，可另购遥控器RC-A6进行无线遥控，使用2.4G无线技术，可同时分别控制16个LED灯，32组通道频率，99个无线ID，抗干扰强。

注：使用前请把LED灯与遥控器的 频道(CH)、组别(GR)、ID调至一致。  
LED灯在开机状态下才可以接收无线信号。

按MENU按键进入MENU界面，旋转CCT/FN旋钮：

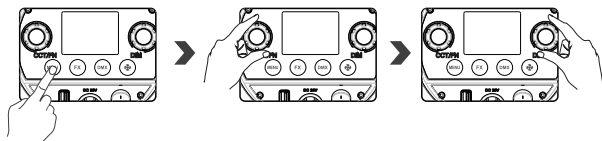

选择CH再旋转DIM旋钮，可进行频道设置(1~32)。

选择GR再旋转DIM旋钮，可进行组别设置(A/B/C/D/E/F,0~9)。

选择ID再旋转DIM旋钮，可进行ID设置(OFF/01~99)。

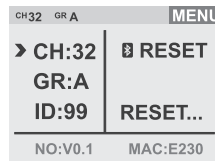

## 3. 蓝牙控制

3.1 蓝牙重置功能：在MENU界面旋转CCT/FN旋钮，选择RESET,再短按CCT/FN旋钮，实现蓝牙重置功能。

注：首个移动设备（手机或平板电脑）可直接使用APP操控灯体。

更换其他移动设备（手机或平板电脑）时，灯体进行蓝牙重置后，方可正常使用APP连接。

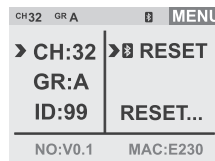

3.2 直接扫二维码即可下载“Godox Light”手机APP。（安卓和苹果系统都可以使用）

具体操作请参考手机APP“帮助”手册，里面有详情教程。



## 产品参数

LED灯	SZ200Bi
供电	AC100V-240V (50/60HZ)
输出功率	200W
频道	32个
组别	16组 (A、B、C、D、E、F,0-9)
色温范围	2800K ~ 6500K
调光范围	0%-100%
100%光照度 (LUX) (≈)	最大约32500 (测试距离1米)
CRI (≈)	97
TLCI (≈)	96
工作环境温度	-10°C ~ 40°C
光效模式	8类共22种场景模式
模式	双色模式/场景模式
变焦	照射角度20° ~65°
控制方式	手机APP/2.4G无线/DMX控制台智能遥控
静音模式	有
2.4G无线控制距离	50米
显示	彩屏
产品尺寸	336*198.6*165mm
净重量	2.54kg

\* 设计和规格如有变更，恕不另行通知。

## 维护保养

- 为了防止灰尘的堆积影响到产品的性能，请定时用干净的湿布轻轻擦拭产品外部。
- 1年保修，消耗品适配器，适配器电源线等配件不在此保修范围内。
- 对于不规范操作引起的机器故障不在保修范围内。
- 所有维修概由本厂指定可供原厂配件之维修部负责。
- 经发现，擅自检修本品，将取消一年保修期，维修需要收取相关费用。
- 如果本品出现故障或者被水淋湿，在专业人员维修后方可继续使用。
- 如有技术更改，恕不另行通知。

本设备包含型号核准代码为: CMIIT ID:2020DP13510, 为该产品的无线电发射模块。

# Foreword

Thank you for purchasing this Godox Product!

This Zoom Bi-color LED Video Light SZ200Bi is a continuous light with multiple functions. Suitable for almost all shooting occasions e.g. live, camping, portrait shooting, make up, video, wedding, children photography, etc. It's portable and easy to be operated.

### Features:

- Freely switch LED bicolor mode and 22 situational special effects modes
- Easy to adjust color temperature, light brightness
- Combined control by smartphone APP/2.4G wireless/DMX control
- Without noise and interference in silent mode
- Offer strong light in light burst mode
- With a colored display to clearly show the parameters
- Excellent heat dissipation system

## ⚠ Warning

- ⚠ Always keep this product dry. Do not use in rain or in damp conditions.
- ⚠ Do not disassemble. Should repairs become necessary, this product must be sent to an authorized maintenance center.
- ⚠ Keep out of reach of children.
- ⚠ As this product do not have waterproof function, please take measures of waterproof in rainy or damp environment.
- ⚠ As this product may heat up in working, please do not touch.

# Name of Body

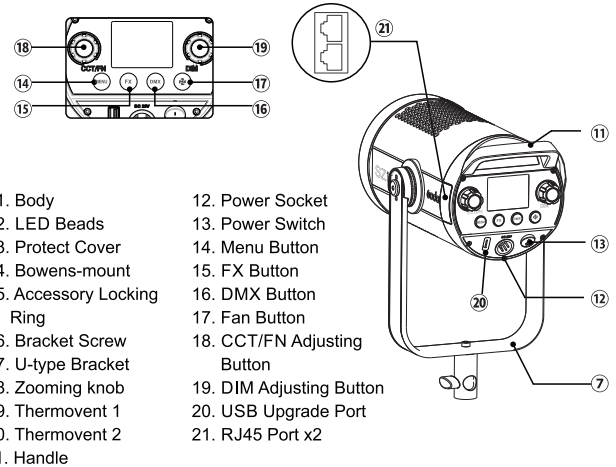
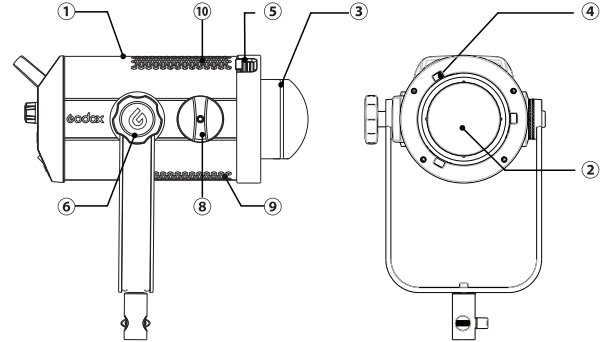

- |                            |                             |
|----------------------------|-----------------------------|
| 01. Body                   | 12. Power Socket            |
| 02. LED Beads              | 13. Power Switch            |
| 03. Protect Cover          | 14. Menu Button             |
| 04. Bowens-mount           | 15. FX Button               |
| 05. Accessory Locking Ring | 16. DMX Button              |
| 06. Bracket Screw          | 17. Fan Button              |
| 07. U-type Bracket         | 18. CCT/FN Adjusting Button |
| 08. Zooming knob           | 19. DIM Adjusting Button    |
| 09. Thermovent 1           | 20. USB Upgrade Port        |
| 10. Thermovent 2           | 21. RJ45 Port x2            |
| 11. Handle                 |                             |



## LCD Panel

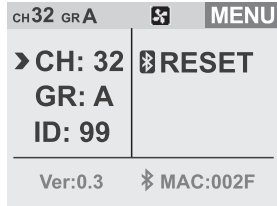

### • Menu Interface

1. CH Chanel
2. GR Group
3. 2.4G Wireless ID
4. Bluetooth Reset Function
5. V0.3 (version number)
6. MAC(Bluetooth number)

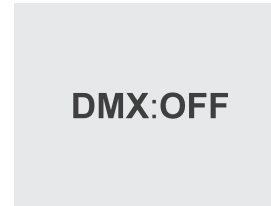

### • DMX Interface

1. DMX Channel Display (OFF/1 to 512)

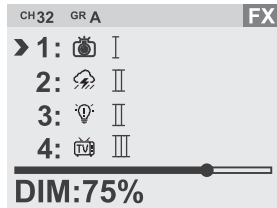

### • FX Interface

1. FX Special Effects Display from 1 to 8

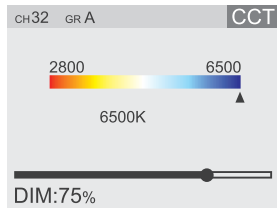

### • CCT Interface

1. CCT Function Display from 2800K to 6500K

## Included Items

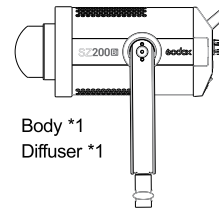

Body \*1  
Diffuser \*1

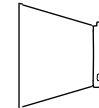

Reflector \*1

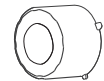

Protect Cover \*1



Steel Cable \*1



Clip \*1



Adapter \*1



Power Cable \*1



LSA-18 Power Adapter Holder \*1



Instruction Manual \*1

## Optional Accessory

The product can be used in combination with the following optional accessories so as to achieve best photography effects:

RC-A6 Remote control, inverter, softbox, umbrella, light stand, honey comb, beauty dish, snoot, etc.

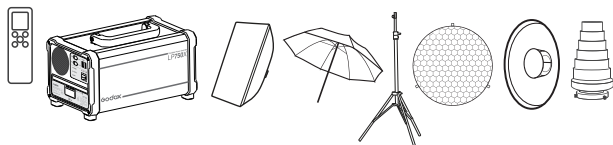

## Power Supply

Connect the LED light to power source with adapter and power cable. Press the power switch to turn on the LED light.

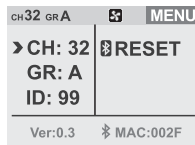
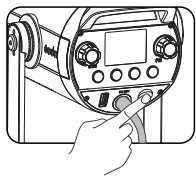

## Operation

### • Menu Button

Press the MENU button and the LED light will enter menu interface. In this interface, CH channel (1 to 32), GR group (A/B/C/D/E/F,0-9), ID (OFF/01 to 99), Bluetooth function (RESET), etc.

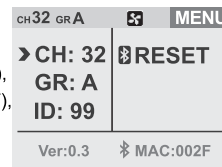





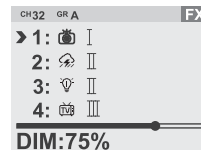

### • FX Button

Turn the CCT/FN select dial to choose the special effect modes from 1 to 8 categories. After choosing the current mode, short press the CCT/FN select dial to switch the modes from I, II and III.



22 different special effects which are divided into 8 categories according to your demands.

No.	Display	Situation	Display I	Display II	Display III
1		Flash	Flash	Press conference	Paparazzi
2		Lightning	Discontinuous	Frequent	Sustainable
3		Broken bulb	Discontinuous	Frequent	Sustainable
4		TV	Slow speed	Medium speed	Quick speed
5		Candle	Discontinuous	Frequent	Sustainable
6		Fire	Firewood	Campfire	Fire hazard
7		Firework	Brief	Continuous	Show
8	<b>SOS</b>	SOS			

### • DMX Button

Short press the DMX button to enter the setting interface. Choose DMX channels from OFF, 001 to 512. By connecting to the control center through RJ45 port. The parameters of LED light can be controlled by the control center.

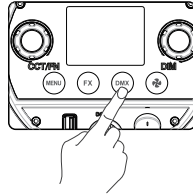

### • Color temperature

The LED light will auto enter color temperature adjustment interface. Turn the CCT/FX button to choose color temperature from 2800K to 6500K.

### • Brightness adjustment

In FX or CCT interface, turn the DIM select dial to adjust brightness from 0% to 100%. Press the DIM select dial once to turn off the brightness and press it again to recover the brightness set before.

Note: when the LED light is powered on, press the DIM select dial once can turn on or off the brightness quickly in any interface.

### • Fan Button

Short press the fan button to control the on/off of the fan.

1. When the fan is off, the LED light will enter silent mode. There is no noise and interference in this mode and the brightness can be adjusted from 0% to 35%.
2. When the fan is on, the LED light can be set to strong light mode. The LED light's power will up to the maximum in this mode.

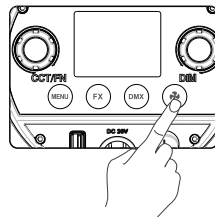

### • Zooming Knob

By adjusting this knob, the beam angle can be changed from 20° to 65°.

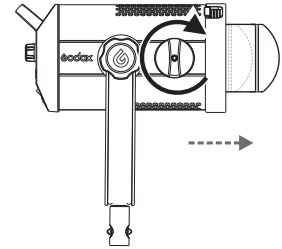

### • USB Upgrade Port

1. Download the new firmware into U disk from official website <http://www.godox.com.cn/Downloads.html>.
2. Turn off the LED light. Insert the U disk with new firmware into the USB upgrade port.
3. Turn on the LED light, and it will automatically enter the upgrading interface.
4. The LED light will automatically back to the main interface.

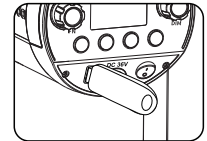

**Note:** 1. The newest firmware must be downloaded from the official website and stored in the root directory of U disk. And there can only be one BIN document.

2. The USB port can only support firmware upgrade function.

# Control Mode Selection

## 1. DMX Control Setting

In MENU interface, choose DMX options to set DMX channels (OFF/001~512). Connect the LED light to DMX control panel by RJ45 port. Set them to the same channel, the LED lights can be controlled by control panel.



Mode Channel	CCT	FX	Note
n	0-51	52-255	1. DMX means the value set on the central control. 2. n means the channel of DMX. 3. The channels of two lights cannot be overlapped.
n+1	DMX*(100/255)Integer 0-100% Light Brightness	DMX*(100/255) Integer 0-100% Light Brightness	
n+2	DMX*(Max. Color Temperature - Min. Color Temperature) /100/255 Integer	DMX*(Total Number of Light Effect/255)	
n+3		0-85: I 86-171: II 172-255: III	

## 2. 2.4G Wireless Control

With 2.4G wireless system, SZ series LED video light has remote grouping and control function. It is recommended to purchase RC-A6 remote control(optional) to achieve wireless control. Up to 16 groups of LED lights can be controlled, 32 channels and 99 IDs are available with strong anti-interference capability.

Note:

1. Please make LED light's channel(CH), group(GR) and ID to the same as remote control's.
2. The wireless signals can only be received in the situation that the LED light is powered on.

Press the MENU button to enter MENU interface and turn the CCT/FN select dial:

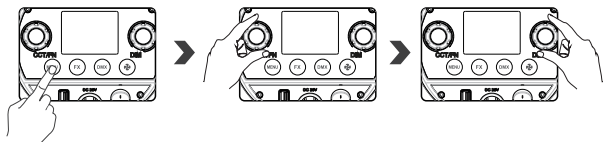

Select CH and turn the DIM select dial to choose channels from 1 to 32.  
 Select GR and turn the DIM select dial to choose groups from A to E and 0 to 9.  
 Select ID and turn the DIM select dial to choose IDs from OFF, 01 to 99.

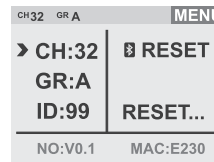

## 3. Bluetooth Control

3.1 Bluetooth reset function: in MENU interface, turn the CCT/FN select dial to choose RESET. Then, short press CCT/FN select dial to reset.

Note: the APP can be used directly on the firstly installed device (smartphone or iPad). When change to other mobile device(smartphone or iPad), the light shall be reset before the normal connection of APP.

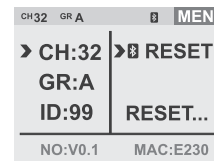

3.2 Scan the QR code to download the "Godox Light" smartphone APP(can be used by Android and Apple system). For more smartphone APP operations, please open the "help" in APP to gain detailed guidance.



## Technical Data

LED Light	SZ200Bi
Power Supply	AC100V-240V(50/60HZ)
Output Power	200W
Channel	32
Group	16(A, B, C, D, E, F, 0-9)
Color Temperature Range	2800K~ 6500K
Brightness Range	0%-100%
RGB Hue	0~360°
100% Illuminance (LUX)(≈)	Max. 32500(1-meter testing distance)
CRI (≈)	97
TLCI (≈)	96
Working Environment Temperature	-10°~40°C
Special Effects Modes	8 Categories(22 kinds)
Mode	Bicolor mode/ situational mode
Zooming	Beam Angle 20°~65°
Control Method	Smartphone APP/2.4G wireless/ DMX intelligent control
2.4G Wireless Transmission Distance	50m
Silent Mode	Yes
Display	Color Display
Dimension	336*198.6*165mm
Net Weight	2.54kg

\* Product design and specifications are subject to change without notice.

## Maintenance

This product, except consumables e.g. adapter and adapter cable, is supported with a one-year warranty.

Avoid sudden impacts and the product should be dedusted regularly.

Maintenance of the flash must be performed by our authorized maintenance department which can provide original accessories.

Unauthorized service will void the warranty.

If the product had failures or was wetted, do not use it until it is repaired by professionals.

Changes made to the specifications or designs may not be reflected in this manual.

## FCC Statement

This device complies with part 15 of the FCC Rules. Operation is subject to the following two conditions: (1) This device may not cause harmful interference, and (2) this device must accept any interference received, including interference that may cause undesired operation.

Any Changes or modifications not expressly approved by the party responsible for compliance could void the user's authority to operate the equipment.

**Note:** This equipment has been tested and found to comply with the limits for a Class B digital device, pursuant to part 15 of the FCC Rules. These limits are designed to provide reasonable protection against harmful interference in a residential installation. This equipment generates uses and can radiate radio frequency energy and, if not installed and used in accordance with the instructions, may cause harmful interference to radio communications. However, there is no guarantee that interference will not occur in a particular installation. If this equipment does cause harmful interference to radio or television reception, which can be determined by turning the equipment off and on, the user is encouraged to try to correct the interference by one or more of the following measures:

- Reorient or relocate the receiving antenna.
- Increase the separation between the equipment and receiver.
- Connect the equipment into an outlet on a circuit different from that to which the receiver is connected.
- Consult the dealer or an experienced radio/TV technician for help.

## Warning

Operating frequency:2412.99MHz – 2464.49MHz(2.4G only receive)/2402MHz – 2480MHz(BT)

Maximum EIRP Power: -3.31dBm

## Declaration of Conformity

GODOX Photo Equipment Co.,Ltd. hereby declares that this equipment are in compliance with the essential requirements and other relevant provisions of Directive 2014/53/EU. In accordance with Article 10(2) and Article 10(10), this product is allowed to be used in all EU member states.For more information of DoC, Please click this web link: [https://www.godox.com/DOC/GoDox\\_SZ200Bi\\_DOC.pdf](https://www.godox.com/DOC/GoDox_SZ200Bi_DOC.pdf)

The device complies with RF specifications when the device used at 0mm from your body.