

合格证
QC PASS

深圳市神牛摄影器材有限公司

地址: 深圳市宝安区福海街道塘尾社区耀川工业区厂房2栋

电话: 0755-29609320(8062) 传真: 0755-25723423 邮箱: godox@godox.com

GODOX Photo Equipment Co., Ltd.

Add: Building 2, Yaochuan Industrial Zone, Tangwei Community, Fuhai Street, Bao'an District,

Shenzhen, China Tel: +86-755-29609320(8062) Fax: +86-755-25723423 E-mail: godox@godox.com

godox.com

Made in China



Godox

双色温LED摄影灯
Bi-color LED Video Light

ML60Bi

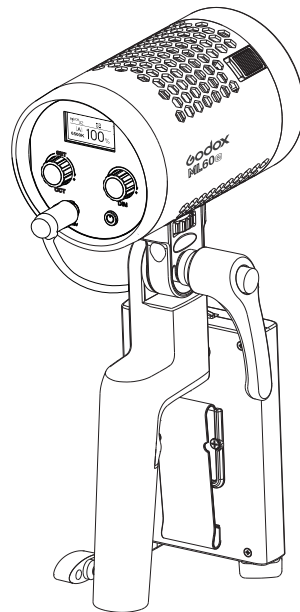

说明手册

Instruction Manual

前言

感谢您购买神牛产品！

双色温LED摄影灯ML60Bi是一款高亮度，可无线调控，色温可调，可手持也可固定在灯架上进行补光的常亮灯。适用于任何场景：直播、静物拍摄、视频录播、婚纱摄影、儿童拍摄及有限空间内补光。轻松动感补光、轻巧便携，操作便捷。

产品有以下亮点：

- 一灯多用，随心切换LED色温模式和21种情景光效模式
- 0%~100%精确调节亮度
- 16组32频道无线分组调控
- 静音非静音模式随心切换，创作无干扰
- 体积轻巧，方便手持，自由布光
- 自由调节色温
- 多灯联控,手机APP/2.4G无线控制
- 具备高温报警功能和低电量提示功能，安全便捷

警告

- △ 保持干燥；请勿用湿手接触产品，请勿将产品浸入水中或暴露于雨中。
- △ 请勿私自拆卸产品，如产品出现故障须由本公司或授权的维修人员进行检查维修。
- △ 请勿让儿童接触本产品。
- △ 本产品没有防水功能，在雨天及潮湿环境下请注意防水。
- △ 请勿在化学品、可燃性气体或其他特殊物质附近使用摄影灯。在这些场合下，请注意相关警告标识。
- △ 请使用专用的充电器进行充电，并且按正确的操作说明，在规定的电压、温度范围内使用。

部件名称

• 灯头

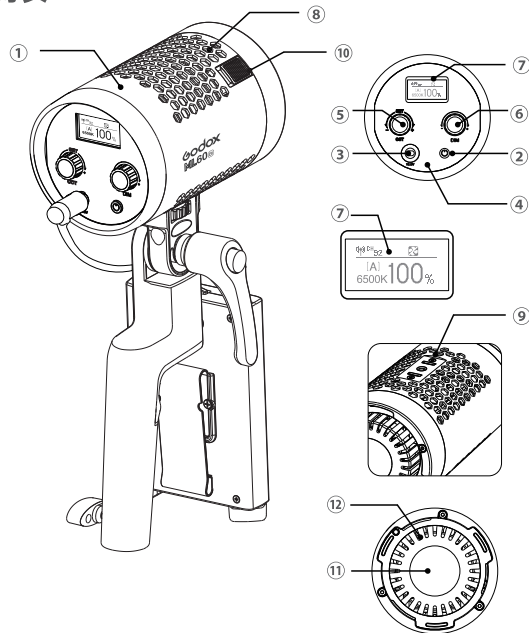

- | | |
|-----------------|--------------|
| 01. 机身 | 07. 显示屏 |
| 02. 开关按键 | 08. 散热孔 |
| 03. DC电源插孔 | 09. 手柄支架固定螺孔 |
| 04. 控制面板 | 10. 卡口推制 |
| 05. CCT/SET按键旋钮 | 11. LED灯珠 |
| 06. DIM旋钮 | 12. 散热器 |

• 手柄

- 13. 手柄支架
- 14. 手柄方向调节旋钮
- 15. 手柄固定灯头旋钮
- 16. 灯架固定旋钮
- 17. 手柄电池盒固定扣

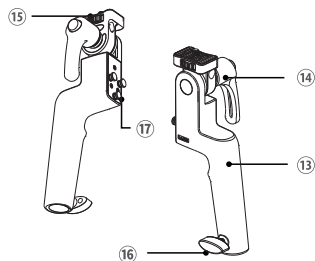

• 电池盒

- 18. 电池背夹
- 19. 手柄电池盒固定孔
- 20. 手柄电池盒固定推制
- 21. 电池卡槽1和电池卡槽2
- 22. 电池电量显示按键/电池装卸推制
- 23. 电量指示灯
- 24. 电池盒站立支撑脚
- 25. 电池供电输出口

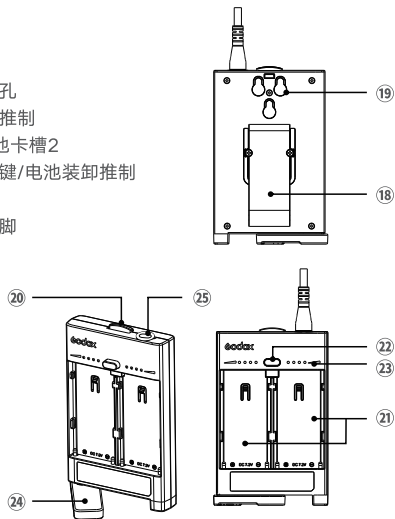

标配物品

灯头ML60Bi *1

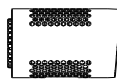

手柄 *1



电池盒BC60 *1



适配器 *1



反光罩 *1



灯头保护盖 *1



AC电源线5M *1



DC电源线1.5M *1



DC电源线0.2M *1



适配器固定座 *1

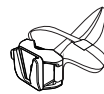

便携包 *1



说明书 *1



选配物品

遥控器RC-A6



电源管理

适配器供电：输入：100-240V ~ 50/60Hz 2A，输出：16.8V 4.2A。

外置电池供电：电池盒上装2个NP-F970，用DC电源线连接电池盒跟灯头即可供电。

电池电量：电量指示灯提示电池电量，四格绿点代表满电，三格绿点代表剩余75%电量，两格绿点代表剩余50%电量，一格绿点代表剩余25%电量，不足一格绿点时，显示屏会显示低电提示。

备注：电池盒只供电池放电，不能给电池充电。使用电池盒供电必须两个电池同时使用，不支持单个电池供电使用。

功能使用操作说明

1. 开关机

短按开关按键，控制机子的打开和关闭，OLED显示主机当前信息。

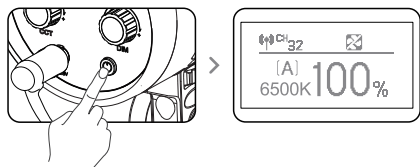

2. 模式选择：色温模式/FX光效模式

2.1 色温模式：主界面即为色温模式。

2.1.1 色温调节：在主界面旋转CCT/SET旋钮，可进行色温调节(2800~6500K)。正常旋转100个单元值，快速旋转500个单元值。

2.1.2 亮度调节：旋转DIM旋钮可进行亮度调节，调节范围为0%-100%。

2.2 光效模式：情景光效模式有7类21种：

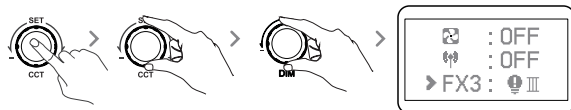

序号	显示	场景	显示 I	显示 II	显示 III
Fx1	闪光灯	闪光灯	闪光	发布会	狗仔队
FX2	雷闪电	雷闪电	间歇	频繁	持续
FX3	坏灯泡	坏灯泡	间歇	频繁	持续
FX4	电视机	电视机	慢速	中速	快速
FX5	蜡烛	蜡烛	间歇	频繁	持续
FX6	火	柴火	篝火	篝火	火灾
FX7	烟花	烟花	短暂	连续	演出

① 小提示：旋转DIM旋钮选择光效类型，然后短按DIM旋钮实现速率切换。

3. 2.4G无线设置：

ML60Bi具有2.4G无线接收功能，可另购遥控器RC-A6进行无线遥控，使用2.4G无线技术功能，可同时分别控制16个组别，32个频道，99个无线ID，抗干扰强。（注：使用前请把遥控器与LED灯的频道(CH),组别(GR), ID设为一致，LED灯在开机的状态下才能接收无线信号。）

开关2.4G无线：按CCT/SET按键进入菜单，旋转CCT/SET旋钮至无线符号，再旋转DIM旋钮开或关2.4G无线。



通道CH设置：按CCT/SET按键进入菜单，旋转CCT/SET旋钮至CH，再旋转DIM旋钮设置通道，有32(1-32)个频道供选择。



组别GR设置：按CCT/SET按键进入菜单，旋转CCT/SET旋钮至GR，再旋转DIM旋钮设置组别，有16组(A-E,0-9)组别供选择。



ID设置：按CCT/SET按键进入菜单，旋转CCT/SET旋钮至ID，再旋转DIM旋钮设置ID，有OFF或1-99供选择。



4.亮度调节：

直接在主界面旋转DIM调节亮度大小，正常旋转1个单元值，快速旋转10个单元值。按一次DIM旋钮可关闭亮度，再按一次DIM旋钮可恢复上次关闭的亮度。



5.静音模式开启：显示屏主界面显示☐时为静音模式。

开启静音模式：按CCT/SET按键进入菜单，旋转DIM旋钮打开或关闭风扇，设置为ON时为非静音模式，设置为OFF时为静音模式。静音模式时，亮度可调范围0%~50%。

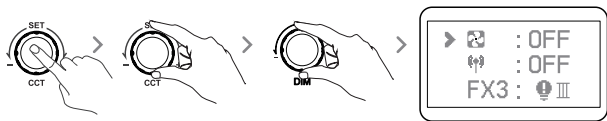

6.装卸电池盒：

6.1 装电池盒：电池盒固定孔卡入手柄电池盒固定扣，卡好后往下拉电池盒，听到咔声表示已装好电池盒。

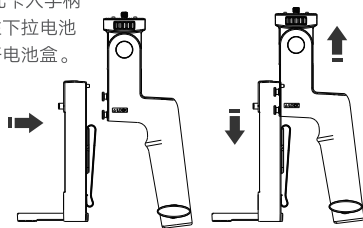

6.2 拆卸电池盒：扣住手柄电池盒固定推制往上推电池盒，再往外拿出电池盒。

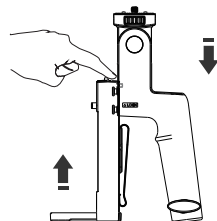

6.3 连接电池盒和灯头：用电源线一端插入电池盒，另一端插入灯头DC插座。

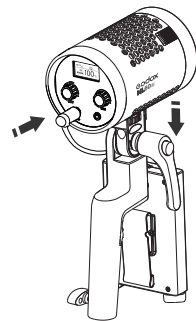

6.4 电池盒装入2个FP970电池即可通电。

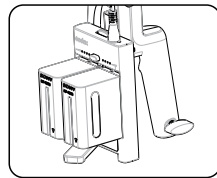

7. 低电提示：

当电量低于一格时，显示屏自动弹出低电量提示符号。



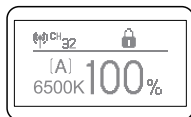
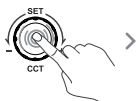

8. 锁定功能：

开机状态下，长按CCT/SET按键2秒，屏幕上方显示锁定符号可进行功能锁定，再长按2秒可解锁。



注意：仅锁定控制面板功能，2.4G无线遥控和蓝牙远程控制不受影响。

9. 高温报警功能

- 9.1 当LED灯珠温度过高时，显示屏会显示高温报警符号.
- 9.2 当LED灯珠温度恢复正常，灯体会自动解除报警，此时可以旋转DIM旋钮改变亮度。
- 9.3 当显示屏出现温度传感器故障符号, 即代表该机器高温报警功能失效。

10. 蓝牙设置：

10.1 按CCT/SET按键进入菜单,旋转CCT/SET旋钮至蓝牙符号, 旋转DIM旋钮(OFF/蓝牙MAC码/Reset选择), 选择OFF时蓝牙关闭; 选择蓝牙MAC码(例如:CE8C)时, 蓝牙打开, 主界面出现蓝牙符号。选择Reset再按DIM按钮可进行蓝牙重置功能。



10.2 直接扫二维码即可下载“Godox Light”手机APP。(安卓和苹果系统都可以使用)

具体操作请参考手机APP“帮助”手册，里面有详情教程。



注：首个移动设备（手机或平板电脑）可直接使用APP操控灯体。更换其他移动设备（手机或平板电脑）时，灯体进行蓝牙重置后，方可正常使用APP连接。

产品参数

LED摄影灯	ML60Bi
适配器	输出16.8V 4.2A
功率	最大60W
频道	32个
组别	16组 (A B C D E F, 0-9)
调光范围	0%~100%
100%光照度(LUX) (≈)	10100 (测试距离为1米)
CRI (≈)	96
TLCI (≈)	97
色温	2800 ~ 6500K(不含反光罩)
模式	色温模式、场景模式
光效模式	共7类21种
控制方式	手机APP/2.4G无线控制
2.4G无线传输距离	30米
蓝牙传输距离	30米
工作环境温度	-10~40°C
重量	0.77Kg (不含手柄和反光罩)
产品尺寸	145*88*88mm (不含手柄和反光罩)

* 设计和规格如有变更，恕不另行通知。

维护保养

- 为了防止灰尘的堆积影响到产品的性能，请定时用干净的湿布轻轻擦拭产品外部。
- 1年保修，消耗品电池，充电器，充电器电源线等配件不在此保修范围内。
- 对于不规范操作引起的机器故障不在保修范围内。
- 所有维修概由本厂指定的可供原配件的维修部负责。
- 经发现，擅自检修本品，将取消一年保修期，维修需要收取相关费用。
- 如果本品出现故障或者被水淋湿，在专业人员维修后方可继续使用。
- 如有技术更改，恕不另行通知。

本设备包含型号核准代码为:CMIIIT ID:2020DP13510，为该产品的无线电发射模块。

Foreword

Thank you for purchasing this Godox Product!

This Bi-color LED Video Light ML60Bi is a light that is easy to fill. It has high brightness, wireless adjustable, and color temperature adjustable functions. Suitable for almost all shooting occasions e.g. live, camping, make up, portrait shooting, make up, video, wedding, children photography, etc. It's portable and easy to be operated.

Features:

- Freely switch LED bi-color mode and 21 Light effects modes
- 0% to 100% Precisely adjust light brightness
- 16 Groups and 32 channels wireless remote control
- Switch silent mode to light without interference
- Compact and lightweight, easy to be held in hand
- Freely adjust color temperature
- Combined control by smartphone APP/2.4G wireless

⚠ Warning

- ⚠ Always keep this product dry. Do not use in rain or in damp conditions.
- ⚠ Do not disassemble. Should repairs become necessary, this product must be sent to an authorized maintenance center.
- ⚠ Keep out of reach of children.
- ⚠ As this product do not have waterproof function, please take measures of waterproof in rainy or damp environment.
- ⚠ Do not use the flash unit in the presence of flammable gases, chemicals and other similar materials. In certain circumstance, these materials may be sensitive to the strong light emitting from this flash unit and fire or electromagnetic interference may result.

Parts

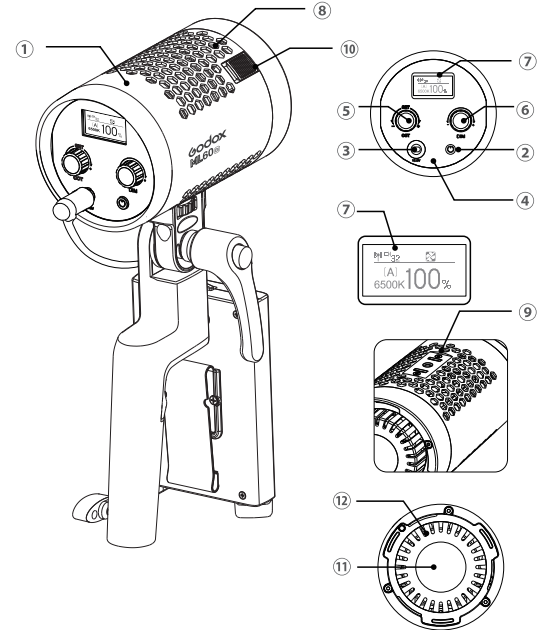

- | | |
|-------------------------|------------------------------|
| 01. Body | 07. Display |
| 02. Power Switch | 08. Thermovent |
| 03. DC Power Socket | 09. Fixing Socket for Handle |
| 04. Control Panel | 10. Accessory Locking Ring |
| 05. CCT/SET Select Dial | 11. LED Light Beads |
| 06. DIM Select Dial | 12. Radiator |

• Handle

- 13. Handle Bracket
- 14. Direction Adjusting Ring
- 15. Fixing Screw for Light Head
- 16. Fixing Screw for Light Stand
- 17. Fixing Buckle for Battery Case

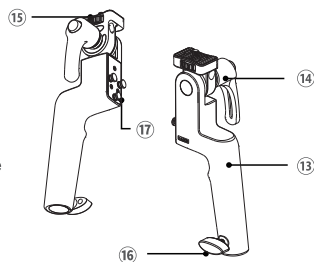

• Battery Case

- 18. Clip
- 19. Fixing Hole for Battery Case
- 20. Locking Ring for Battery Case
- 21. Battery Compartment 1 and 2
- 22. Battery Level Display Button/
Battery Locking Ring
- 23. Battery Level Indicator
- 24. Battery Case Leg
- 25. Battery Power Output Port

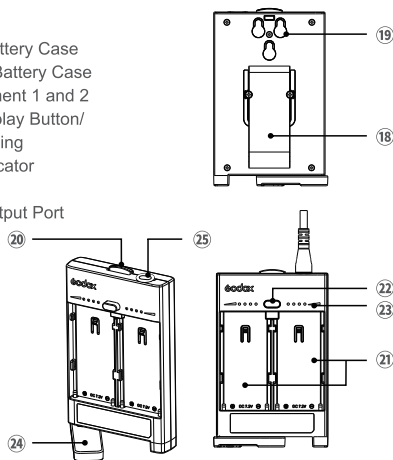

What's in the Box

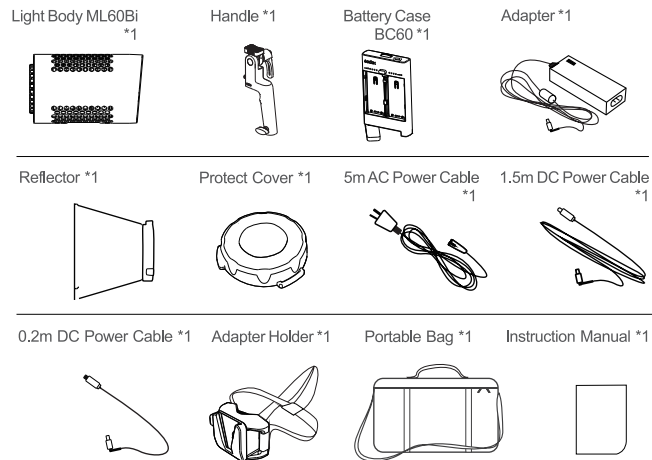

Optional Accessory

RC-A6 remote control



Power Management

1. Power Supply

Adapter power supply: input: 100-240V~50/60Hz 2A, output: 16.8V 4.2A.

External battery power supply: install two NP-F970 batteries into the battery compartment. Then, use DC power line to connect the battery case with the light body to achieve power supply.

The battery case can only offer battery discharging instead of charging. When powered by battery box, two batteries shall be used simultaneously. Please do not use one battery individually.

Operation

1. Power On

Press the power switch to control the on/off of the light, and the OLED display will show the current information.

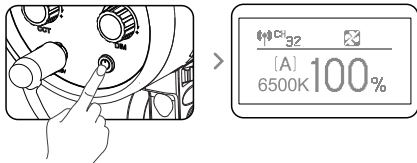

2. Mode Selection: Bi-color mode/FX Special Effects Mode

Color temperature mode: the main interface is the color temperature mode

2.1.1 Color temperature adjustment: Rotate the CCT/SET knob on the main interface to adjust the color temperature (2800~6500K). Normally rotate 100 unit values, and quickly rotate 500 unit values.

2.1.2 Brightness Adjustment: Select the DIM dial to adjust brightness from 0% to 100%.

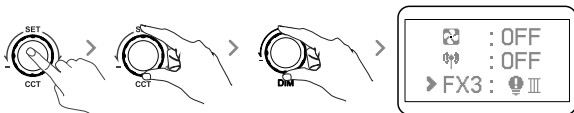

2.2 Light effect mode: There are seven types and 21 kinds of light effect modes.

Special Effects	Display	Situation	Display I	Display II	Display III
Fx1		Flash	Flash	Press conference	Paparazzi
Fx2		lightning	Discontinuous	Frequent	Continuous
Fx3		Broken bulb	Discontinuous	Frequent	Continuous
Fx4		TV	Slow speed	Medium speed	Quick speed
Fx5		Candle	Intermittently	Frequent	Continuous
Fx6		Fire	Wood fire	Bonfire	Fire
Fx7		Fireworks	Short	Continuous	Performance

① Tip: Rotate DIM dial to select light efficiency type, and then press DIM dial to realize speed switching.

3. 2.4G Wireless setting

ML60Bi has 2.4G wireless receiving function, and the remote control RC-A6 can be purchased separately for wireless remote control. Using 2.4G wireless technology function, it can control 16 Groups, 32 channels, and 99 wireless IDs at the same time, with strong anti-interference.

Note: Before use, please set the channel (CH), group (GR) and ID of the remote control and the LED light to be the same. The LED light can only receive wireless signals when it is turned on.

Turn on/off 2.4G wireless: press CCT/SET button to enter the menu. Turn the CCT/SET select dial until the wireless icon is displayed. Then, turn the DIM select dial to turn on or off 2.4G wireless.



Channel CH Setting: press CCT/SET button to enter the menu. Turn the CCT/SET select dial until the CH is displayed. Then, turn the DIM select dial to choose channel from 1 to 32.

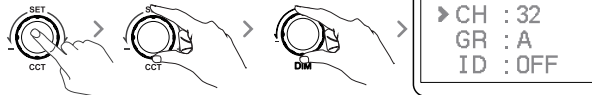

Group GR Setting: press CCT/SET button to enter the menu. Turn the CCT/SET select dial until the GR is displayed. Then, turn the DIM select dial to choose group from A to E and 0 to 9.

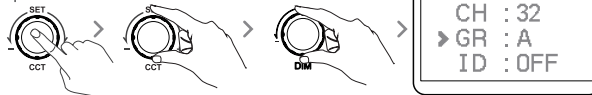

ID setting: press CCT/SET button to enter the menu. Turn the CCT/SET select dial until the ID is displayed. Then, turn the DIM select dial to choose 99 IDs from 1 to 99.

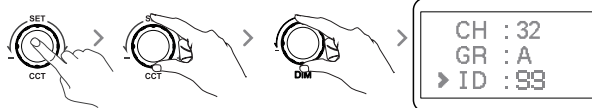

4. Brightness adjustment: Rotate DIM to adjust brightness, normally rotate 1 unit value, and quickly rotate 10 unit value.

Note: Press the DIM select dial to turn off brightness, and then press dim to restore the brightness of the last time it was turned off.



5. Silent mode:

When  is displayed, the silent mode is turned on.

Turn on the silent mode: press CCT/SET button to enter the menu. Then, screw the DIM select dial to turn on or off the fan. Set it to on to enter non-silent mode while set it to off to enter silent mode. In silent mode, the brightness adjustment range is from 0% to 50%.

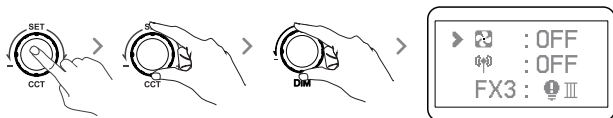

6. Install and detach battery case

6.1 Install battery case: Aim the handle's fixing buckles into the battery case's fixing holes, pull the batter case downwards until being tightened.

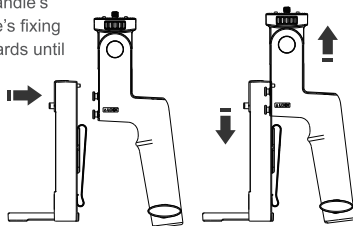

6.2 Detach battery case: push the battery case' locking ring and push the battery case upwards to take it out.

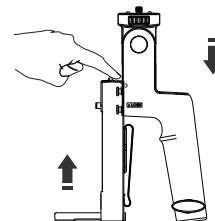

6.3 Connect the battery case with light head: Insert one end of the power cord into the battery box and the other end into the DC socket of the lamp cap.

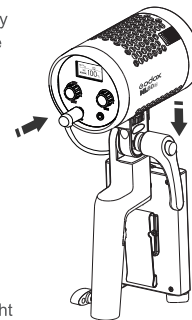

6.4 Insert two FP970 batteries, and the LED light can be put into usage.

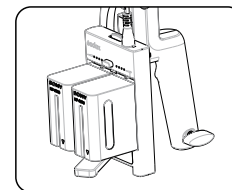

7. Low Battery Indication

When the battery is below one grid, the low battery indicator will pop out.

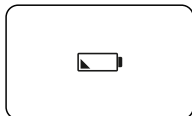

8. Locking Function

In power on state, long press the CCT/SET button for 2 seconds and the locking icon will appear on the display. Long press the button for 2 seconds again to unlock.

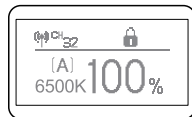
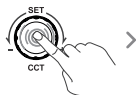

Note: The locking function only locks the control panel function, the 2.4G wireless remote control and Bluetooth control are not affected.

9. High Temperature Alarm Function

9.1 When the LED Light bead temperature is too high, the display screen will display the high temperature alarm symbol

9.2 When the LED Light temperature returns to normal, the lamp will automatically release the alarm. At this time, the DIM dial can be rotated to change the brightness.

9.3 When the temperature sensor failure symbol appears on the display, it means that the high temperature alarm function of the machine has failed.

10. Bluetooth Control

10.1 Press the CCT/SET button to enter the menu, turn the CCT/SET knob to the Bluetooth symbol , turn the DIM knob (OFF/Bluetooth MAC code/Reset cycle selection), select OFF when the Bluetooth is turned off; When the Bluetooth MAC code (For example: CE8C) is selected, Bluetooth is turned on and the Bluetooth symbol appears on the main interface; select Reset and then press the DIM button to perform the Bluetooth reset function.



Note: The first mobile device (mobile phone or tablet) can directly use the APP to control the light body. When replacing other mobile devices (mobile phones or tablets), the lamp body can be connected normally after Bluetooth reset.



10.2 Scan the QR code to download the "Godox Light" mobile app. (It can be used on both Android and Apple systems) (QR code diagram) . For specific operations, please refer to the "Help" manual of the mobile APP, which contains detailed tutorials.

Warning

Operating frequency: 2412.99MHz – 2464.49MHz(2.4G only receive)/2402MHz – 2480MHz (BT)
Maximum EIRP Power: 3.76dBm

Declaration of Conformity

GODOX Photo Equipment Co.,Ltd. hereby declares that this equipment are in compliance with the essential requirements and other relevant provisions of Directive 2014/53/EU. In accordance with Article 10(2) and Article 10(10), this product is allowed to be used in all EU member states. For more information of DoC, Please click this web link: https://www.godox.com/DOC/Godox_ML60Bi_DOC.pdf
The device complies with RF specifications when the device used at 0mm from your body.

Technical Data

LED Light	ML60Bi
Adapter	Output: 16.8V 4.2A
Power	Max. 60W
Channel	32
Group	16(A B C D E F,0-9)
Brightness Adjusting Range	0%~100%
100% Illuminance(LUX)(≈)	10100 (testing distance is 1 meter)
CRI(≈)	96
TLCI(≈)	97
Color Temperature	2800~6500K (without reflector)
Mode	Bi-color mode/scene mode
Lighting effects mode	A total of 7 categories and 21 types
Control method	Mobile APP/2.4G wireless control
2.4G wireless transmission distance	30 meters
Bluetooth transmission distance	30 meters
Working Temperature	-10~40°C
Weight	0.77Kg (not include handle and reflector)
Dimension	145*88*88mm (not include handle and reflector)
BT Frequency Range	2402.0-2480.0MHz
Max. Transmitting Power	5dbm

* Product design and specifications are subject to change without notice.

Maintenance

This product, except consumables e.g. charger and charger cable, is supported with a one-year warranty.

Avoid sudden impacts and the product should be dedusted regularly.

Maintenance of the flash must be performed by our authorized maintenance department which can provide original accessories.

Unauthorized service will void the warranty.

If the product had failures or was wetted, do not use it until it is repaired by professionals.

Changes made to the specifications or designs may not be reflected in this manual.

FCC Statement

This device complies with part 15 of the FCC Rules. Operation is subject to the following two conditions: (1) This device may not cause harmful interference, and (2) this device must accept any interference received, including interference that may cause undesired operation.

Any Changes or modifications not expressly approved by the party responsible for compliance could void the user's authority to operate the equipment.

Note: This equipment has been tested and found to comply with the limits for a Class B digital device, pursuant to part 15 of the FCC Rules. These limits are designed to provide reasonable protection against harmful interference in a residential installation. This equipment generates uses and can radiate radio frequency energy and, if not installed and used in accordance with the instructions, may cause harmful interference to radio communications. However, there is no guarantee that interference will not occur in a particular installation. If this equipment does cause harmful interference to radio or television reception, which can be determined by turning the equipment off and on, the user is encouraged to try to correct the interference by one or more of the following measures:

- Reorient or relocate the receiving antenna.
- Increase the separation between the equipment and receiver.
- Connect the equipment into an outlet on a circuit different from that to which the receiver is connected.
- Consult the dealer or an experienced radio/TV technician for help.

The device has been evaluated to meet general RF exposure requirement.

The device can be used in portable exposure condition without restriction.

产品保修

尊敬的用户，本保修卡是申请保修服务的重要凭证，请您配合销售商填写并妥善保管，谢谢！

产品信息	型号	产品条码
用户信息	姓名	联系电话
	通信地址	
销售商信息	名称	
	联系电话	
	通信地址	
	销售日期	
备注		

注：此表应由销售商盖章确认。

适用产品

本文件适用于相关《产品保修信息》(见后面说明)所列产品，其他非属此范围的产品或部件(如促销品、赠品及其他出厂后附加的部件等)不在此保修承诺内。

保修期

产品及部件的相应保修期按相关的《产品保修信息》执行。保修期自产品首次购买日起算，购买日以购买产品时保修卡登记日期为准。

如何获得保修服务

您可直接与产品销售商或授权服务机构联系，也可拨打神牛产品售后服务电话，与我们联系，由我们的服务人员为您安排服务。申请保修时，您应提供有效的保修卡作为保修凭证，方可获得保修。如您不能提供有效的保修卡，则在我们确认产品或部件属于保修范围的情况下，也可以为您提供保修，但这不作为我们的义务。

不适用保修的情况

如产品存在下列情况，本文件项下的保证和服务将不适用 ①产品或部件超过相应保修期；②错误或不当使用、维护或保管导致的故障或损坏，如：不当搬运；非按产品合理预期用途使用；不当插拔外接设备；跌落或外力挤压；接触或暴露于不适当温度、溶剂、酸碱、水浸或潮湿环境；③由非神牛授权机构或人员安装、修理、更改、添加或拆卸造成的故障或损坏；④产品或部件原有识别信息被修改变更或删除；⑤无有效保修卡；⑥使用非合法授权、非标准或非公开发行的软件造成的故障或损坏；⑦因不可抗力或意外事件造成的故障或损坏；⑧其他非因产品本身质量问题导致的故障或损坏。遇上述情况，您应向相关责任方寻求解决，神牛对此不承担任何责任。因非在保修期或保修范围内的部件、附件或软件导致产品不能正常使用的，不是保修范围内的故障。产品使用过程中正常的脱色，磨损和消耗，不是保修范围内的故障。

产品保修和服务支持信息

产品的保修期和服务类型按以下《产品保修信息》执行：

产品类别	选项名称	保修期(月)	保修服务类型
部件	电路板	12	客户送修
	电池	3	客户送修
	充电器、电源线，同步线等带电性能的部件。	12	客户送修
其他	如闪光管、造型灯泡、外壳、保护罩、锁紧装置、包装等。	无	无保修

神牛产品售后服务电话 0755-29609320-8062

Warranty

Dear customers, as this warranty card is an important certificate to apply for our maintenance service, please fill in the following form in coordination with the seller and safe-keep it. Thank you!

Product Information	Model	Product Code Number
Customer Information	Name	Contact Number
	Address	
Seller Information	Name	
	Contact Number	
	Address	
	Date of Sale	
Note:		

Note: This form shall be sealed by the seller.

Applicable Products

The document applies to the products listed on the **Product Maintenance Information** (see below for further information). Other products or accessories (e.g. promotional items, giveaways and additional accessories attached, etc.) are not included in this warranty scope.

Warranty Period

The warranty period of products and accessories is implemented according to the relevant Product Maintenance Information. The warranty period is calculated from the date (purchase date) when the product is bought for the first time. And the purchase date is considered as the date registered on the warranty card when buying the product.

How to Get the Maintenance Service

If maintenance service is needed, you can directly contact the product distributor or authorized service institutions. You can also contact the Godox after-sale service call and we will offer you service. When applying for maintenance service, you should provide valid warranty card. If you cannot provide valid warranty card, we may offer you maintenance service once confirmed that the product or accessory is involved in the maintenance scope, but that shall not be considered as our obligation.

Inapplicable Cases

The guarantee and service offered by this document are not applicable in the following cases: ①. **The product or accessory has expired its warranty period;** ②. **Breakage or damage caused by inappropriate usage, maintenance or preservation, such as improper packing, improper usage, improper plugging in/out external equipment, falling off or squeezing by external force, contacting or exposing to the improper temperature, solvent, acid, base, flooding and damp environments, etc;** ③. **Breakage or damage caused by non-authorized institution or staff in the process of installation, maintenance, alternation, addition and detachment;** ④. **The original identifying information of product or accessory is modified, alternated, or removed;** ⑤. **No valid warranty card;** ⑥. **Breakage or damage caused by using illegally authorized, nonstandard or non-public released software;** ⑦. **Breakage or damage caused by force majeure or accident;** ⑧. **Breakage or damage that could not be attributed to the product itself.** Once met these situations above, you should seek solutions from the related responsible parties and Godox assumes no responsibility. The damage caused by parts, accessories and software that beyond the warranty period or scope is not included in our maintenance scope. The normal discoloration, abrasion and consumption are not the breakage within the maintenance scope.

Maintenance and Service Support Information

The warranty period and service types of products are implemented according to the following **Product Maintenance Information**:

Product Type	Name	Maintenance Period(month)	Warranty Service Type
Parts	Circuit Board	12	Customer sends the product to designated site
	Battery	3	Customer sends the product to designated site
	Electrical parts e.g.battery charger, power cord, sync cable, etc.	12	Customer sends the product to designated site
Other Items	Flash tube, modeling lamp, lamp body, lamp cover, locking device, package, etc.	No	Without warranty

Godox After-sale Service Call 0755-29609320-8062