

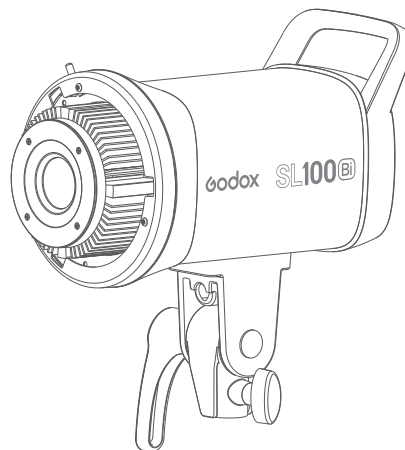

# Godox



Wechat  
Official Account  
神牛微信公众号

### 深圳市神牛摄影器材有限公司

地址: 深圳市宝安区福海街道塘尾社区耀川工业区厂房2栋 电话: 0755-29609320(8062)  
传真: 0755-25723423 邮箱: godox@godox.com

### GODOX Photo Equipment Co.,Ltd.

Add.: Building 2, Yaochuan Industrial Zone, Tangwei Community, Fuhai Street, Bao'an District, Shenzhen  
518103, China Tel: +86-755-29609320(8062) Fax: +86-755-25723423 Email: godox@godox.com

[www.godox.com](http://www.godox.com)

Made in China | 705-SL10BY-00



# SL100<sup>Bi</sup>

双色温LED摄影灯  
Bi-color LED Video Light

使用手册  
Instruction Manual

## 重要的安全说明及注意事项

**首先作为最基本原则：本产品为专业灯光布景设备，应由专业灯光师使用或在专业人士指导下使用。使用时必须始终遵循基本的安全预防措施，具体安全防护措施如下：**

1. 使用前必须阅读并理解产品说明书。
2. 专业灯具，禁止儿童使用。当儿童靠近时，家长或监护人必须密切监督，以免儿童因碰撞灯具或私用灯具造成人身伤害。
3. 本灯具并非普通照明灯具，不可用于普通照明，任何有过眼部损伤或眼部敏感的人群均应避免使用本灯具。
4. 灯具点亮时，必须小心使用，禁止接触高温部件，如LED灯珠，以免造成灼伤。
5. 灯具点亮时，任何情况下均禁止直视灯珠。应该在专业灯光师指导下使用强光，任何情况下避免长时间处于强光环境，如引起眼睛不适，请及时关闭灯具，暂停使用，请及时就医。
6. 倘灯珠损坏或因热变形，应停止使用，并及时联系制造商、服务代理商或合格的维修人员更换灯珠，以免发生意外。
7. 本产品仅适用于-10°C-40°C工作环境温度及正常湿度环境下使用。
8. 请勿使用损坏的设备或设备配件，待专业维修人员检查维修，确认设备正常方可使用。
9. 在使用过程中，如果本产品由于跌落、受到挤压或遭受强烈冲击而造成外壳破裂的，请勿继续使用，以免因接触到内部电子元件而受到电击伤害。
10. 如需要延长线，请使用额定电流≥该设备额定电流的延长线。如延长线额定电流小于该设备，可能导致过热。
11. 部分产品电源线较长，请合理放置电源线，使其处于安全位置。避免电源线接触过热物体表面、避免放置不当导致拉扯损坏或绊倒现场人员。请使用原厂原装电源线，如使用非原厂电源线导致产品损坏，概不在本厂维修范围内。
12. 在清洁和维修之前，请务必从电源插座上拔下该设备插头。不使用时，禁止拉扯电源线以将设备插头从电源插座中拔出。正常断电，应是用手抓住该设备插头两端，将插头从电源插座中拔出。此设备需连接到接地插座中。
13. 本设备没有防水性能，请让设备保持干燥，请勿将本设备浸入水中或其他液体中。设备需安装在干燥且通风处，避免在雨天、潮湿、多尘或过热环境下使用。请勿将任何物体置于灯具上或使液体流入灯具内部，以免发生意外。
14. 请勿私自拆卸产品，如产品出现故障，须由本公司或授权的维修人员进行检查维修。
15. 存放本设备之前，请确保设备已完全冷却。存放时，将电源线从设备上拔出。设备应放置于设备便携包内或通风干燥处。
16. 请勿将设备放置在酒精、汽油等易燃易挥发的溶剂附近。
17. 本厂不推荐的产品附件，请勿使用，以免导致火灾、触电或人身伤害。
18. 清洁本设备时，请勿用湿布擦拭，请用干布，软布擦拭设备污垢。
19. 设备使用前，请注意将保护罩取下。
20. 本产品已通过ROHS, CE, 和FCC认证，请参考相关国家标准使用和操作。

21. 安全说明依据本厂严格测试制定，设备设计和规格如有变更，恕不另行通知。客户可以上神牛官网查看最新的电子版说明，了解产品最新资讯。
22. 部分产品内置锂电池。此类产品请使用专用的充电器进行充电，并且按正确的操作说明，在规定的电压、温度范围内使用。
23. 部分产品使用电池供电。此类产品请勿使用说明书中未指定的任何电池、电源或附件。请将电池和其他附件置于儿童及婴幼儿无法触及之处。如果儿童或婴幼儿吞下电池或附件，请立即就医。如果电池漏液、变色、变形、冒烟或发出异味，请立即将其取出。在取出过程中请小心，以免烫伤。如果继续使用，可能会引起火灾、触电或皮肤烫伤。请勿使用任何变形或改造过的电池。请勿拆卸或改造本产品或电池。请勿加热电池或焊接电池。请勿让电池与火或水接触。请勿让电池受到强烈的外力撞击。请勿将电池的正负端错误插入，或将新旧电池或不同类型的电池混合使用。
24. 一年保修期，消耗品电池、适配器、电源线等配件不在此保修范围内。
25. 经发现，擅自检修设备，将取消一年保修期，维修需要收取相关费用。
26. 对于不规范操作引起的机器故障不在保修范围内。

## 保存这些说明

## 前言

感谢您购买神牛产品!

双色温LED摄影灯SL100Bi是一款色温可调、亮度可调，带有2.4G、蓝牙无线功能、11种光效的长亮LED灯，适用于采访、摄影棚、静物拍摄等场景。

多种遥控方式，操作便捷。

## 主要特点

- 拥有色温可调功能，色温调节范围(2800K~6500K)
- 输出光源稳定，0%~100%精确调节亮度
- 配置11种FX光效模式，模拟各种拍摄场景，轻松实现创意光效
- 享有手机APP、2.4G无线等传输功能，可无线调节LED灯
- 能够和现有的保柔卡口灯光附件通用
- 选用LCD屏，实现清晰显示
- 具备良好的散热性能

## 警告

使用器材时，应始终遵循基本的安全预防措施，具体如下：

- ⚠ 使用前，请阅读并理解所有说明。
- ⚠ 儿童请勿靠近或者使用该设备，当儿童靠近或使用设备时，监护人有必要进行密切监督。在使用过程中，请勿将设备置于无人看管状态。
- ⚠ 该设备工作时会有发热现象，请小心触摸!
- ⚠ 请勿在电源线损坏的情况下操作设备，请勿私自拆卸产品，如产品出现故障须由本公司或授权的维修人员进行检查维修。
- ⚠ 请放置好电源线，防止操作人员被电源线绊倒，禁止拉扯电源线以免导致设备断电，且电源线不可接触灼热表面。
- ⚠ 如果需要延长线，则其额定电流至少等于应使用该设备的产品。额定电流小于该设备电源线可能出现过热情况。
- ⚠ 在清洁和维修之前，请务必从电源插座上拔下电源插头。不使用时，切勿拉扯电线将插头从插座中拔出。应当抓住插头并拉动拔出。
- ⚠ 该设备没有防水功能，为减少危险，请勿将本产品浸入水中或其他液体。
- ⚠ 需要维修时，应将其交给本公司或授权的维修人员进行检查维修。不正确的维修行为，可能在随后使用设备时出现触电情况。
- ⚠ 本产品工作时，请勿遮挡散热口，请勿直视COB灯珠，任何情况下请勿触摸COB灯珠。

## 部件名称

- 灯体

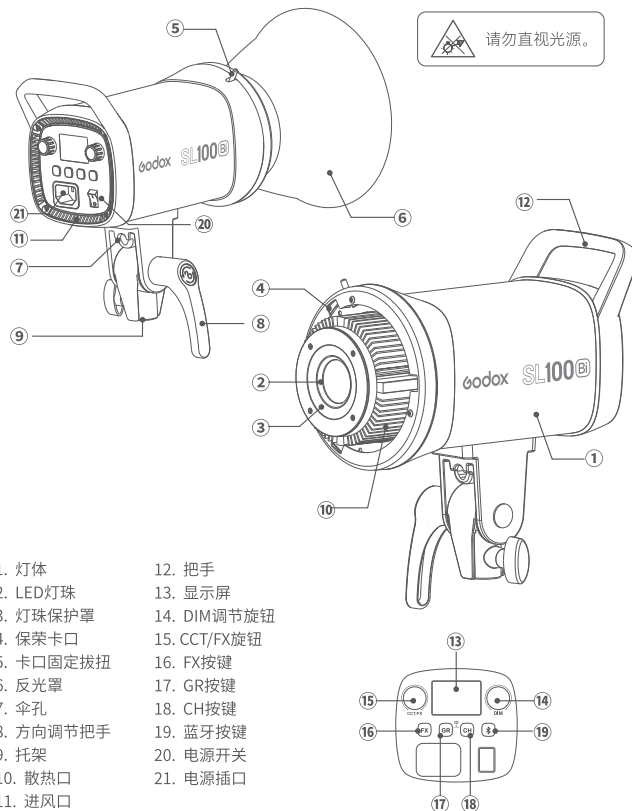

## 显示屏

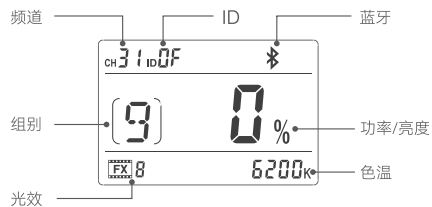

## 标配物品

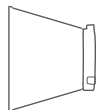
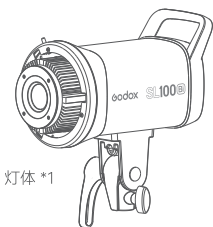

## 可选购附件

可搭配本公司以下摄影附件使用，以获得最佳的拍摄效果和使用体验：  
RC-A6遥控器、逆变器、柔光箱、反光伞、灯架、蜂巢、雷达罩、束光筒等。

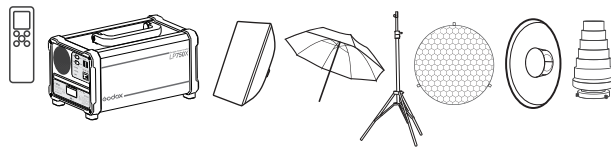

## 接通电源

通过电源线接通交流电源，拨动LED灯上的电源开关，实现开机或关机。

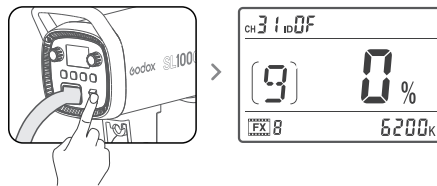

## 操作说明

亮度调节：旋转DIM调节旋钮可进行调节亮度，左旋-/右旋+，调节范围0%~100%，正常旋转1个单元值，快速旋转10个单元值。

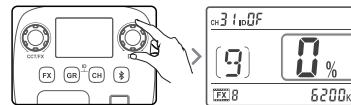

**色温调节:** 在常亮LED灯模式下, 旋转CCT/FX旋钮可进行色温调节, 左旋-/右旋+, 调节范围2800K~6500K; 正常旋转100个单位值, 快速旋转500个单位值。

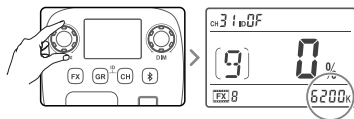

#### • 光效模式

短按FX按键进入或退出光效模式。进入光效模式时显示屏显示FX, 旋转CCT/FX旋钮选择光效场景。有11种FX光效模式, 模拟各种拍摄场景, 轻松实现创意光效。

显示	FX1	FX2	FX3	FX4	FX5	FX6	FX7	FX8	FX9	FX10	FX11
场景	Flash 1	Flash 2	Flash 3	Storm 1	Storm 2	Storm 3	TV	坏灯泡	蜡烛	火	烟花

## 2.4G无线设置

SL100Bi LED灯具备无线遥控功能, 可另购遥控器RC-A6进行无线遥控, 使用2.4G无线技术, 可同时分别控制16组灯, 32个频道, 99个无线ID, 抗干扰性强。

注: 使用前请把遥控器(另购)与LED灯的频道(CH), 组别(GR), ID设为一致, LED灯在开机的状态下才能接收无线信号。

**CH频道调节:** 短按CH按键, 显示屏上CH参数图标闪烁, 旋转DIM调节旋钮可进行频道调节, 左旋-/右旋+, 调节范围1~32。再次短按退出CH设置。

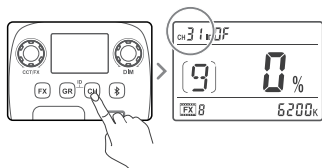

**GR组别调节:** 短按GR按键, 显示屏上GR参数图标闪烁, 旋转DIM调节旋钮可进行组别调节, 左旋-/右旋+, 调节范围0~9/A~F。再次短按退出GR设置。

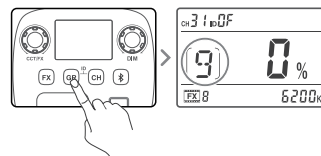

**ID设置:** 同时长按CH和GR按键, 显示屏上ID参数图标闪烁, 旋转DIM调节旋钮可进行ID设置, 左旋-/右旋+, 调节范围OFF/1~99。再次长按CH和GR按键, 退出ID设置, 恢复主界面正常显示。

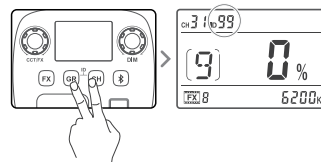

## 蓝牙设置

1. 查看蓝牙MAC码: 短按蓝牙按键显示屏上显示蓝牙MAC码, 再次短按蓝牙按键, 蓝牙MAC码消失, 恢复主界面正常显示。

2. 直接扫二维码即可下载“Godox Light”手机APP。(安卓和苹果系统都可以使用)



具体操作请参考手机APP“帮助”手册, 里面有详情教程。

3. 蓝牙重置功能: 长按2秒蓝牙按键, 显示屏上蓝牙图标闪烁, 实现蓝牙重置功能, 重置完成后图标恢复长亮。

注: 首个移动设备(手机或平板电脑)可直接使用APP操控灯体。更换其他移动设备(手机或平板电脑)时, 灯体进行蓝牙重置后, 方可正常使用APP连接。

## 故障提醒功能



亮代表风扇故障。



闪烁代表有故障。



亮表示高温报警。



闪烁表示进入高温保护状态，灯体自动进入关闭程序。

## 产品参数

LED灯	SL100Bi
供电	AC100V~240V(50/60HZ)
输出功率	100W
频道	32个
组别	16组(0~9/A、B、C、D、E、F)
ID	OFF/1-99
色温范围	2800K ~ 6500K
调光范围	0%~100%
100%光照度(LUX)	最大≈ 32100
加标准罩，测试距离1米	
CRI	≥96
TLCI	≥97
工作环境温度	-10° ~ 40°
模式	双色温模式/场景模式
光效模式	共11种场景模式
控制方式	手机APP/2.4G无线控制
蓝牙传输距离	≈30米
2.4G无线传输距离	≈30米
照射角度	120°
产品尺寸	243*205*127 mm
净重量	1.6kg(不含反光罩)

\* 设计和规格如有变更，恕不另行通知。

## 维护保养

- 为防止灰尘的堆积影响到产品的性能，请定时用干净的湿布轻轻擦拭产品外部。
- 所有维修概由本厂指定可供原厂配件之维修部负责。
- 1年保修，消耗品电池、电源线等配件不在此保修范围内。
- 经发现，擅自检修此LED灯的，将取消LED灯之一年保修期，维修需要收取相关费用。
- 本品如出现故障或者被水淋湿，在专业人员维修后方可继续使用。
- 设计和规格如有变更，恕不另行通知。

本设备包含型号核准代码为: CMIIT ID:2020DP13510，为该产品的无线电发射模块。

## Safety Instructions and Attentions

First of all, as the most basic principle: This product is a professional lighting set equipment and should be used by professional lighting engineers or under the guidance of professionals. Basic safety attentions must always be followed during use, as follows:

1. Before use, please read and understand these instructions and attentions.
2. Professional lighting is prohibited for children. When children are near, parents or accompanying persons must supervise closely to prevent children from personal injury due to collision with lamps or private use of lamps.
3. This lighting product is not ordinary lighting product and cannot be used for general lighting. Anyone who has suffered eye damage or has sensitive eyes should avoid using this product.
4. When the lamp is on, it must be used with care. Do not touch high-temperature parts, such as LED lamp beads, to avoid burns.
5. When the lamp is on, it is forbidden to look directly at the lamp beads under any circumstances. Strong light should be used under the guidance of professional lighting engineers. Avoid prolonged exposure to strong light under any circumstances. If eye discomfort, please turn off the lamp in time, suspend use, and see a doctor immediately.
6. If the lamp bead is damaged or deformed by heat, stop using this equipment, and contact the manufacturer, service agent or qualified maintenance personnel to replace the lamp bead in time to avoid accidents.
7. This product is only suitable for use in -10°C to 40°C operating environment and normal humidity environment.
8. Do not use damaged equipment or accessories, and wait for professional maintenance personnel to check and repair to confirm being normal before use.
9. During using, if the casing of this product is broken due to being dropped, squeezed or subjected to strong impact, please do not use it, so as to avoid electric shock injury due to contact with internal electronic components.
10. If an extension cord is required, please use an extension cord with a current rating greater than or equal to that of the equipment. If an extension cord is rated less than the equipment, overheating may result.
11. Some products have long power cords, please place the power cords properly and keep them in a safe place. Avoid contacting the power cord with overheating surfaces, avoid improper placement that could cause pulling damage, or trip on-site personnel. Please use the certified power cord from the original manufacturer. If the product is damaged by using a non-certified power cord, it will not be repaired by our factory.
12. Be sure to unplug equipment from the power outlet before cleaning and repairing. When not in use, do not pull the power cord to unplug the equipment. For normal power-off, please hold both ends of the plug of the equipment with your hands and pull the plug out of power outlet. This equipment needs to be connected to a grounded outlet.
13. This equipment is not waterproof, please keep it dry and do not immerse it in water or other liquids. The equipment should be installed in a dry and ventilated place, and avoid using it in rainy, humid, dusty or overheated environments. Do not place any objects on the lamp or let liquid flow into the lamp to avoid accidents.
14. Do not disassemble the product without permission. If the product fails, it must be checked and repaired by authorized maintenance personnel.
15. Before storing, make sure that the equipment has cooled down completely. For storage, unplug the power cord from the equipment. The equipment should be placed in the carrying case or in a ventilated dry place.
16. Do not place equipment near flammable and volatile solvents such as alcohol and gasoline.
17. Do not use accessories that are not recommended by our factory to avoid fire, electric shock or personal injury.
18. When cleaning, do not wipe it with a damp cloth, please use a dry cloth or a soft cloth to wipe the dirt of the equipment.
19. Please take off the protective cover before using.
20. This product complies with ROHS, CE and FCC certification, please refer to the relevant national standards for use and operation.
21. The safety instructions are formulated according to the strict testing of the factory, and the design and specifications of the equipment are subject to change without prior notice. For latest product information, please check the GODOX website and view latest electronic instruction.
22. Some products have built-in lithium batteries. Please use specified chargers, and use them within a proper range of the specified voltage and temperature according to the correct operating instructions.
23. Some products are battery powered. Do not use any batteries, power sources or accessories not specified in the instructions for such products. Keep batteries and other accessories out of the reach of children and infants. In the instance that a child or infant swallows a battery or accessory, immediate emergency medical attention is required. If the battery leaks, becomes discolored, deformed, emits smoke, or emits an abnormal odor, remove it immediately. Be careful during removal to avoid burns. Continued use could result in fire, electric shock, or burns. Do not use any deformed or modified batteries. Do not disassemble or modify this product or battery. Do not heat or solder

the battery. Keep the battery away from fire or water. Do not incorrectly insert the positive and negative ends of batteries, or mix old and new batteries or batteries of different types together.

24. One-year warranty period, accessories such as consumable batteries, adapters, power cords, etc. are not covered by this warranty.
25. If it is found that the equipment is repaired without authorization, the one-year warranty period will be cancelled and relevant fees will be charged for maintenance.
26. Machine failures caused by non-standard operation are not covered by the warranty.

## keep these instructions!

## Foreword

Thank you for purchasing Godox product!  
SL Series LED Video Light SL100Bi is suitable for live recording, video shooting, and many other occasions with stable light resource, even illumination and adjustable color temperature.

## Features

- Freely adjust color temperature from 2800K to 6500K
- With stable light source and adjustable light brightness from 0% to 100%
- With 11 Fx special effects mode to simulate various of shooting scenes
- Can be remote controlled by 2.4G and smartphone APP
- Bowens-mount support various of accessories
- Clear LCD display
- With excellent heat dissipation

## Warning

When using your photographic equipment, basic safety precautions should always be followed, including the following:

- △ Read and understand all instructions before using.
- △ Close supervision is necessary when any appliance is used by or near children. Do not leave appliance unattended while in use.
- △ Care must be taken as burns can occur from touching hot parts.
- △ Do not operate appliance with a damaged cord or if the appliance has been dropped or damaged – until it has been examined by a qualified serviceman.
- △ Position the cord so that it will not be tripped over, pulled, or contact hot surfaces.
- △ If an extension cord is necessary, a cord with a current rating at least equal to that of the appliance should be used. Cords rated for less amperage than the appliance may overheat.
- △ Always unplug appliance from electrical outlet before cleaning and servicing and when not in use. Never yank cord to pull plug from outlet. Grasp plug and pull to disconnect.
- △ This appliance is not waterproof device. To reduce the risk of electric shock, do not immerse this appliance in water or other liquids.
- △ Do not disassemble. Should repairs become necessary, this appliance must be sent to an authorized maintenance center. Incorrect maintenance behavior may cause electric shock when the appliance is subsequently used.
- △ When this appliance is working, please do not cover the Thermovent, and please do not look directly at or touch the COB lamp beads under any circumstances.



## Name of Body

### Light Head

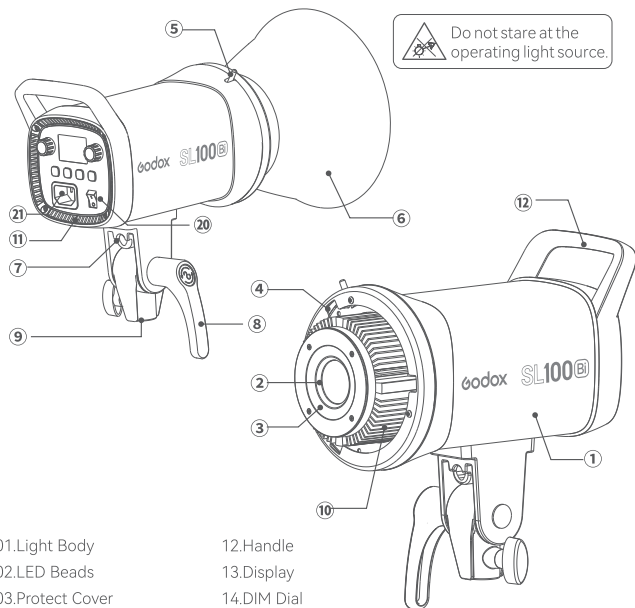

- 01.Light Body
- 02.LED Beads
- 03.Protect Cover
- 04.Bowens-mount
- 05.Accessory Locking Ring
- 06.Reflector
- 07.Umbrella Input
- 08.Direction Adjust
- 09.Bracket
- 10.Thermovent
- 11.Air Inlet
- 12.Handle
- 13.Display
- 14.DIM Dial
- 15.CCT/FX Dial
- 16.FX Button
- 17.GR Button
- 18.CH Button
- 19.Bluetooth
- 20.Power On/Off
- 21.Power Jack

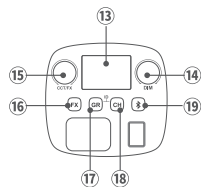

## LCD Panel

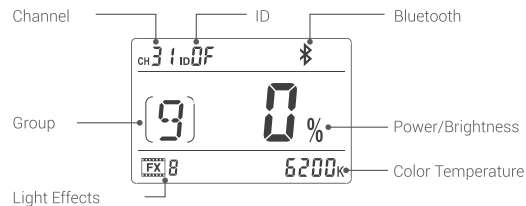

## What's in the Box

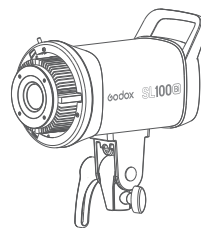

Light Body \*1

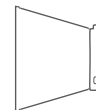

Reflector \*1



Protection Cover \*1



Power Cord \*1



Instruction Manual \*1

## Optional Accessories

The product can be used in combination with the following accessories sold separately, so as to achieve best photography effects: RC-A6 Remote Control, Power Inverter, Softbox, Photographic Umbrella, Light Stand, Honey Comb, Beauty Dish, Snoot, etc.

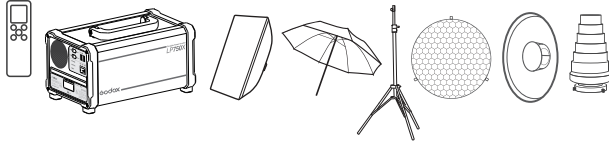

## Power Source

Connect the LED light to power source with power cable. Then, press the power switch to turn it on off.

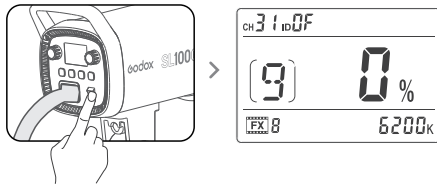

## Operation

**Brightness Adjustment:** turn the DIM dial to adjust brightness from 0% to 100%. Turn the CCT/FX dial to decrease the value while rightwards to increase. And adjust 1 value in normal operation while 10 values in quick operation.

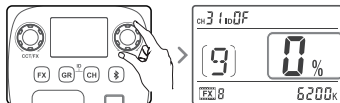

## Color Temperature Adjustment:

in LED continuous lighting mode, turn the CCT/FX select dial to adjust color temperature from 2800K to 6500K. Turn the select dial on the left to decrease the value while rightwards to increase.

Switch 100 unit values at normal speed and 500 unit values at quick speed.

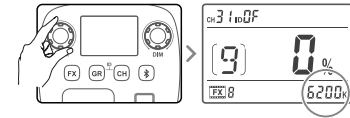

## Light Effects Mode

Short press the FX button to enter or exit the special effects. When entering the FX modes, FX icon will be displayed on the LCD panel. Then, turn the CCT/FX select dial on the left to choose one mode from the 11 special effects modes to achieve creative shooting.

Display	FX1	FX2	FX3	FX4	FX5	FX6	FX7	FX8	FX9	FX10	FX11
Scene	Flash 1	Flash 2	Flash 3	Storm 1	Storm 2	Storm 3	TV	Broken	Candle	Fire	Firework

## 2.4G Wireless Setting

With 2.4G wireless system, LED Video Light SL100Bi has receive and control function. Up to 16 groups of LED lights can be controlled. 32 channels and 99 wireless IDs are available with strong anti-interference capability. Please set the channels, groups and IDs of LED light to the same as those of RC-A6 remote control (optional) before usage.

## CH Channel adjustment:

short press CH button and the CH values will be blinking on the display. Turn the DIM dial on the right to adjust channels from 1 to 32. Turn the select dial leftwards to decrease the value while rightwards to increase. Press the CH button again to confirm.

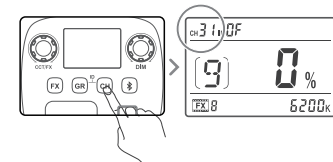

**GR Group adjustment:** short press GR button and the GR values will be blinking on the display. Turn the DIM dial on the right to adjust groups from 0 to 9 and A to F. Turn the select dial leftwards to decrease the value while rightwards to increase. Short press the GR Button again to exit from GR setting.

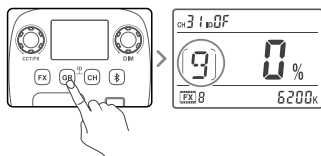

**ID Setting:** long press the CH and GR button together until the ID values is blinking on the display. Turn the DIM dial on the right to adjust IDs from OFF and 1 to 99. Turn the select dial leftwards to decrease the value while rightwards to increase. Then, long press CH and GR button to exit from ID setting.

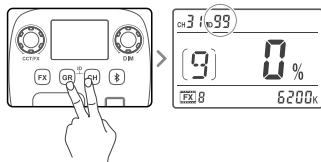

## Bluetooth Setting

**1. Bluetooth MAC code checking:** short press the Bluetooth button until Bluetooth MAC code is displayed. Press the Bluetooth button again and the MAC code will disappear. And the code will be displayed after returning to the main interface.

**2. Scan the QR code to download the "GodoxLight" smartphone APP**(can be used in Android and Apple). For more smartphone APP operations, please open the "help" in APP to gain detailed guidance.



**3. Bluetooth reset function:** long press the SET button for 2 seconds and the Bluetooth icon will blink because of resetting. And the icon will stop blinking after being successfully reset.

**Note:** The APP can be used directly on the firstly installed device (smartphone or iPad). When change to other mobile device (smartphone or iPad), the light shall be reset before the normal connection of APP.

## Failures Reminder

lighting indicates fan failure, flashing indicates failure.  
 lighting indicates high temperature alarm, flashing indicates high temperature protection status and light automatically enters the shutdown procedure.

## Technical Data

LED Light	SL100Bi
Power Supply	AC100V~240V(50/60HZ)
Output Power	100W
Channel	32
Group	16(0~9/A B C D E F)
ID	OFF/1 -99
Color Temperature	2800K~6500K
Light Adjustment Range	0%~100%
100% Illuminance(LUX)	Max. 32100
(with standard reflector, testing distance, 1m)	
CRI	≥96
TLCI	≥97
Temperature of Working Environment	-10° - 40°
Light Effect Mode	11
Control Method	Smartphone APP/2.4G Wireless
Bluetooth Transmission Distance	≈30m
2.4G Wireless Transmission Distance	≈30m
Beam Angle	120°
Dimension	243*205*127mm
Net Weight	1.6kg (not include reflector)
BT Frequency Range	2402.0-2480.0MHz
Max. Transmitting Power	5dbm

Changes made to the specifications or designs may not be reflected in this manual.

## Maintenance

- This product, except consumables e.g. battery, power cable and connect cable, is supported with a one-year warranty.
- Avoid sudden impacts and the product should be dedusted regularly.
- Maintenance of the flash must be performed by our authorized maintenance department which can provide original accessories.
- Unauthorized service will void the warranty.
- If the product had failures or was wetted, do not use it until it is repaired by professionals.
- Changes made to the specifications or designs may not be reflected in this manual.

### Warning

Operating frequency:2412.99MHz – 2464.49MHz(2.4G only receive)/2402MHz – 2480MHz(BT)

Maximum EIRP Power: 5.01dBm

### Declaration of Conformity

GODOX Photo Equipment Co.,Ltd. hereby declares that this equipment are in compliance with the essential requirements and other relevant provisions of Directive 2014/53/EU. In accordance with Article 10(2) and Article 10(10), this product is allowed to be used in all EU member states.For more information of DoC, Please click this web link:

[https://www.godox.com/DOC/Godox\\_SL100Bi\\_SL100D\\_DOC.pdf](https://www.godox.com/DOC/Godox_SL100Bi_SL100D_DOC.pdf)

The device complies with RF specifications when the device used at 0mm from your body.

## FCC Statement

This device complies with part 15 of the FCC Rules. Operation is subject to the following two conditions: (1) This device may not cause harmful interference, and (2) this device must accept any interference received, including interference that may cause undesired operation.

Any Changes or modifications not expressly approved by the party responsible for compliance could void the user's authority to operate the equipment.

Note: This equipment has been tested and found to comply with the limits for a Class B digital device, pursuant to part 15 of the FCC Rules. These limits are designed to provide reasonable protection against harmful interference in a residential installation. This equipment generates uses and can radiate radio frequency energy and, if not installed and used in accordance with the instructions, may cause harmful interference to radio communications. However, there is no guarantee that interference will not occur in a particular installation. If this equipment does cause harmful interference to radio or television reception, which can be determined by turning the equipment off and on, the user is encouraged to try to correct the interference by one or more of the following measures:

- Reorient or relocate the receiving antenna.
- Increase the separation between the equipment and receiver.
- Connect the equipment into an outlet on a circuit different from that to which the receiver is connected.
- Consult the dealer or an experienced radio/TV technician for help.

The device has been evaluated to meet general RF exposure requirement.

The device can be used in portable exposure condition without restriction.

## 产品保修

尊敬的用户，本保修卡是申请保修服务的重要凭证，请您配合销售商填写并妥善保管，谢谢！

产品信息	型号	产品条码
用户信息	姓名	联系电话
	通信地址	
销售商信息	名称	
	联系电话	
	通信地址	
	销售日期	
备注		

注：此表应由销售商盖章确认。

### 适用产品

本文件适用于相关《产品保修信息》(见后面说明)所列产品，其他非属此范围的产品或部件(如促销品、赠品及其他出厂后附加的部件等)不在此保修承诺内。

### 保修期

产品及部件的相应保修期按相关的《产品保修信息》执行。保修期自产品首次购买日起算，购买日以购买产品时保修卡登记日期为准。

### 如何获得保修服务

要保修服务，您可直接与产品销售商或授权服务机构联系，也可拨打神牛产品售后服务电话，与我们联系，由我们的服务人员为您安排服务。申请保修时，您应提供有效的保修卡作为保修凭证，方可获得保修。如您不能提供有效的保修卡，则在我们可确认产品或部件属于保修范围的情况下，也可以为您提供保修，但这不作为我们的义务。

### 不适用保修的情况

如产品存在下列情况，本文件项下的保证和服务将不适用 ①产品或部件超过相应保修期；②错误或不当使用、维护或保管导致的故障或损坏，如：不当搬运；非按产品合理预期用途使用；不当插拔外接设备；跌落或外力挤压；接触或暴露于不当温度、溶剂、酸碱、水浸或潮湿环境；③由非神牛授权机构或人员安装、修理、更改、添加或拆卸造成的故障或损坏；④产品或部件原有识别信息被修改变更或删除；⑤无有效保修卡；⑥使用非法授权、非标准或非公开发行的软件造成的故障或损坏；⑦因不可抗力或意外事件造成的故障或损坏；⑧其他非因产品本身质量问题导致的故障或损坏。遇上述情况，您应向相关责任方寻求解决，神牛对此不承担任何责任。因非在保修期或保修范围内的部件、附件或软件导致产品不能正常使用的，不是保修范围内的故障。产品使用过程中正常的脱色，磨损和消耗，不是保修范围内的故障。

### 产品保修和服务支持信息

产品的保修期和服务类型按以下《产品保修信息》执行：

产品类别	选件名称	保修期(月)	保修服务类型
部件	电路板	12	客户送修
	电池	3	客户送修
	充电器、电源线，同步线等带电性能的部件。	12	客户送修
其他	如闪光灯管、造型灯泡、外壳、保护罩、锁紧装置、包装等。	无	无保修

神牛产品售后服务电话 0755-29609320-8062

## Warranty

Dear customers, as this warranty card is an important certificate to apply for our maintenance service, please fill in the following form in coordination with the seller and safe-keep it. Thank you!

Product Information	Model	Product Code Number
Customer Information	Name	Contact Number
	Address	
Seller Information	Name	
	Contact Number	
	Address	
	Date of Sale	
<b>Note:</b>		

Note: This form shall be sealed by the seller.

### Applicable Products

The document applies to the products listed on the Product Maintenance Information (see below for further information). Other products or accessories (e.g. promotional items, giveaways and additional accessories attached, etc.) are not included in this warranty scope.

### Warranty Period

The warranty period of products and accessories is implemented according to the relevant Product Maintenance Information. The warranty period is calculated from the day (purchase date) when the product is bought for the first time, and the purchase date is considered as the date registered on the warranty card when buying the product.

### How to Get the Maintenance Service

If maintenance service is needed, you can directly contact the product distributor or authorized service institutions. You can also contact the Godox after-sale service call and we will offer you service. When applying for maintenance service, you should provide valid warranty card. If you cannot provide valid warranty card, we may offer you maintenance service once confirmed that the product or accessory is involved in the maintenance scope, but that shall not be considered as our obligation.

### Inapplicable Cases

The guarantee and service offered by this document are not applicable in the following cases: ①. The product or accessory has expired its warranty period; ②. Breakage or damage caused by inappropriate usage, maintenance or preservation, such as improper packing, improper usage, improper plugging in/out external equipment, falling off or squeezing by external force, contacting or exposing to the improper temperature, solvent, acid, base, flooding and damp environments, etc; ③. Breakage or damage caused by non-authorized institution or staff in the process of installation, maintenance, alternation, addition and detachment; ④. The original identifying information of product or accessory is modified, alternated, or removed; ⑤. No valid warranty card; ⑥. Breakage or damage caused by using illegally authorized, nonstandard or non-public released software; ⑦. Breakage or damage caused by force majeure or accident; ⑧. Breakage or damage that could not be attributed to the product itself. Once met these situations above, you should seek solutions from the related responsible parties and Godox assumes no responsibility. The damage caused by parts, accessories and software that beyond the warranty period or scope is not included in our maintenance scope. The normal discoloration, abrasion and consumption are not the breakage within the maintenance scope.

### Maintenance and Service Support Information

The warranty period and service types of products are implemented according to the following **Product Maintenance Information**:

Product Type	Name	Maintenance Period(month)	Warranty Service Type
Parts	Circuit Board	12	Customer sends the product to designated site
	Battery	3	Customer sends the product to designated site
	Electrical parts e.g. battery charger, power cord, sync cable, etc.	12	Customer sends the product to designated site
Other Items	Flash tube, modeling lamp, lamp body, lamp cover, locking device, package, etc.	No	Without warranty

Godox After-sale Service Call **0755-29609320-8062**