

深圳市神牛摄影器材有限公司  
GODOX Photo Equipment Co., Ltd.

地址/Add: 深圳市宝安区福海街道塘尾社区耀川工业区厂房2栋

Building 2, Yaochuan Industrial Zone, Tangwei Community, Fuhai Street, Bao'an District, Shenzhen, China

电话/Tel: +86-755-29609320(8062) 传真/Fax: +86-755-25723423 邮箱/E-mail: godox@godox.com

http://www.godox.com

705-M10000-00

Made In China



Godox



**M1** RGB迷你创意灯  
RGB Mini Creative Light

说明手册  
Instruction Manual

## 一、前言

感谢您购买神牛产品。

RGB迷你创意灯M1可通过按键拨轮调节色温和变换彩光，切换多种情景模式，轻松获得创意光效。外观时尚，操作简单、轻巧便携。适用于微距拍摄、视频拍摄、微电影、直播、人像拍摄、静物拍摄等。

### 主要特点：

- 一灯多用，随心切换LED双色温模式、彩光模式和40种情景特效模式
- 自由调节色温、亮度、色相和色彩饱和度
- 跟随音乐节奏跳动并变换颜色，营造多彩氛围
- 小巧显示屏，精确显示参数
- 自带万向多功能支架，可快速调节补光角度
- 操作简单，轻薄便携
- 多种使用方式

## 警告

- ▲ 请保持干燥：请勿用湿手接触产品，亦不可将产品浸入水中或暴露于雨中。
- ▲ 请勿私自拆卸产品，如产品出现故障须由本公司或授权的维修人员进行检查维修。
- ▲ 请勿让儿童接触本产品。
- ▲ 本产品不能防水，在雨天及潮湿环境下请注意防水。
- ▲ 请勿在化学品、可燃性气体或其他特殊物质附近使用灯，有可能导致火灾或电磁干扰。
- ▲ 内置锂电池，禁止拆卸、撞击、挤压或投入火中，若出现严重鼓胀，请勿继续使用。
- ▲ 请勿放置在超过50℃的高温环境中，否则可能导致电池性能下降或损坏。使用产品要求参数的充电器进行充电，并且正确的按照操作说明，在规定的电压、温度范围内使用。

#### 本说明书中使用的约定

- 此使用说明书中的操作步骤假定相机和闪光灯的电源开关已开启。
- 参考页码由(第\*\*页)表示。
- 此使用说明书中使用以下警告符号：
  - ▲该“小心”符号表示避免出现拍摄问题的警告。
  - 该“注意”符号提供补充信息。

## 目录

01	前言
02	警告
05	部件名称
07	标配物品
08	电池
08	操作说明
15	产品参数
16	热保护功能
17	维护保养

## 二、部件名称

### • 机身

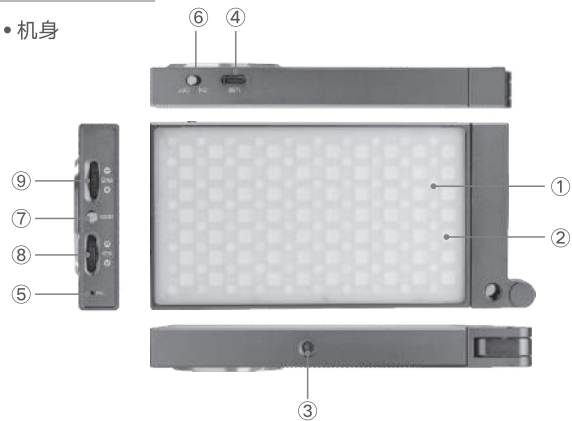

- 01. 灯珠
- 02. 扩散片
- 03. 通用1/4螺孔
- 04. Type-C USB充电接口
- 05. MIC孔
- 06. 开关推钮
- 07. 模式选择按钮
- 08. FN多功能拨轮
- 09. 高度调整拨轮

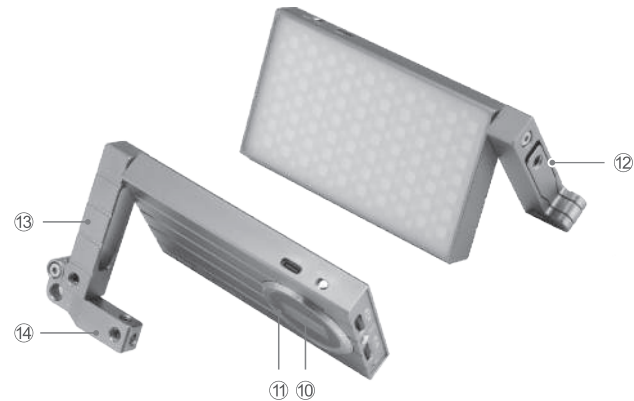

- 10. 显示屏
- 11. 色环
- 12. 多功能支架
- 13. 支架主轴
- 14. 支架收藏轴

### 三、标配物品



1、灯体 2、Type-C USB线 3、冷靴 4、扳手 5、便携包 6、说明书

### 四、电池

1. 本品采用锂离子电池，内置在产品里面不可拆卸，使用寿命长；
2. 安全可靠，内置电路有过充保护、过放保护、过流保护、短路保护；
3. 使用5V/2A充电器充电2个小时左右。

### 注意事项：

1. 充电不要放置超过24小时。
2. 应放置于凉爽、干燥及通风的地方存储。
3. 不要靠近和放置于火中。
4. 电池使用报废后请按当地的规定处理。
5. 长期不使用，请充电至60%再放置。
6. 为了延长电池的使用寿命，建议每三个月进行一次充电保养。
7. 电池有一定的寿命限制，使用一定时间后，性能会减弱，属正常现象。

### 五、操作说明

#### 1. 灯设置

##### 1.1. 开关机

将开关推钮推至ON，灯打开；推至OFF，灯关闭。  
LCD屏将显示主机当前信息。



1.2. 模式选择：双色温模式/彩光模式/情景模式。按MOD按钮切换模式：



显示屏上显示为CCT  
即为双色温模式。



显示HSI即为彩光模式。

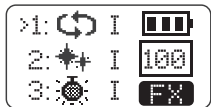

显示FX即为情景特效模式。

1.3. MIC：使用音乐模式时MIC孔需放入音源区，根据效果需求确定音源与灯的距离。



## 2. 双色温模式

2.1 色温调节：向左或向右拨动FN多功能拨轮调节色温，调节范围2500K~8500K。

2.2 亮度调节：拨动亮度调节拨扭调节亮度，亮度调节范围0~100%。



## 3. 彩光模式

3.1 调节色相H：按下FN多功能拨轮选中H，再向上或向下拨动FN多功能拨轮调节色相，色相调节范围0~360°。

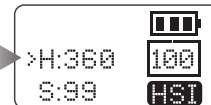

3.2 调节饱和度S：按下FN多功能拨轮选中S，再向上或向下拨动FN多功能拨轮调节饱和度，饱和度调节范围0-100。



3.3 亮度调节：拨动亮度调节拨扭调节亮度，亮度调节范围0~100%。

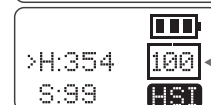

#### 4. FX情景特效模式

4.1 拨动FN多功能拨轮选择特效模式类别，1~15类可选，拨动拨轮循环出现。

4.2 选中后按压FN多功能拨轮可选择当前类别中的模式：I、II、III三种模式，按压拨轮循环出现。

4.3 亮度调节：拨动亮度调节拨扭调节亮度，亮度调节范围0~100%。

4.4 情景特效模式有15类共40种：可根据需求选择。

序号	显示	场景	显示 I	显示 II	显示 III
1		彩光循环	慢速	中速	快速
2		闪光灯	闪光	发布会	狗仔队
3		激光彩灯	生日会	KTV	迪斯科
4		雷闪电	间歇	频繁	持续
5		坏灯泡	间歇	频繁	持续
6		电视机	慢速	中速	快速

序号	显示	场景	显示 I	显示 II	显示 III
7		蜡烛	间歇	频繁	持续
8		火	柴火	篝火	火灾
9		烟花	短暂	连续	演出
10		警车	暴闪	频闪	快闪
11		消防车	暴闪	频闪	快闪
12		救护车	暴闪	频闪	快闪
13		音乐	音乐 I	音乐 II	
14		SOS			
15		爆灯(60s)			

注：

- 1、选中爆灯模式，按下FN键可以开始/停止爆灯，爆灯时灯的亮度和功率达到最大，爆灯时长60秒后灯自动熄灭。
- 2、爆灯模式输出亮度比较高，发热比较快，如果环境温度比较高不建议反复使用该功能，否则会导致高温警示。

## 5. 多功能支架

5.1 主轴：旋转角度为360度。

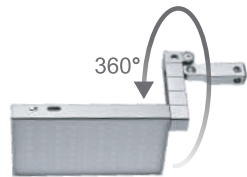

5.2 收藏轴：旋转角度为270度。

1. 先将主轴推出，方便手指伸进收藏槽的角度。



2. 用手指将收藏轴从主轴收藏槽推出即可旋转。

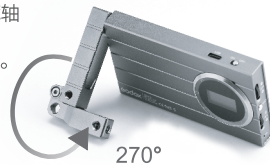

## 5.3 使用方法：



1. 可桌面支撑



2. 可连接灯架



3. 可手持



4. 可连接冷靴



5. 可悬挂

注：支架在反复转动后可能会逐渐变松，当松到影响使用时请使用标配物品中的扳手调节。



## 六、产品参数

型号	M1
充电器 (另购)	5V2A/18W QC3.0(5V3A,9V2A,12V1.5A)
功率	最大13W
色温范围	2500K ~ 8500K
调光范围	0%~100%
RGB色域	0 ~ 360° 全色彩
100%光照度 (LUX)	最大1700
CRI (≈)	97
TLCI (≈)	97
支架旋转角度	主轴360° ; 收藏轴270°
内置锂电池	2410mAh
型号	M1
持续使用时间 (100%功率连续输出)	150分钟左右
工作环境温度	-10~40°C
产品尺寸	145*70*15mm
净重	240g

## 七、热保护功能

为防止过热损坏电池，当温度过高时，屏幕会弹出高温警示符号 ，待温度恢复正常温度，灯恢复正常工作，高温警示消失。

## 八、维护保养

- 灯体在工作时，如发现异常，应立即关掉电源，查明原因。
- 灯体应避免震动，平时注意表面除尘。
- 灯体稍有发热为正常现象，无特别需要时，勿连续引闪。
- 闪光灯的所有维修概由本厂指定可供原厂配件之维修部负责。
- 本产品保修一年，消耗品不在一年保修范围内，内置电池保修六个月。
- 经发现，擅自检修此灯的，将取消灯一年保修期，维修需要收取相关费用。
- 如果本品出现故障或者被水淋湿，在专业人员维修后方可继续使用。

如有技术更改，恕不另行通知。

## Forward

Thank you for purchasing Godox product.

RGB Mini Creative Light M1 can adjust its color temperatures and change different colors. It can easily achieve creative light effects by switching different situational modes. With fashion appearance, simple operation and great portability, M1 is suitable for macro photography, video shooting, microfilm, live, portrait shooting, product shooting, etc.

### Main features:

- Freely switch LED bicolor mode, colorful light mode and 40 situational special effects modes
- Easy to adjust color temperature, light brightness, hue and color saturation
- Blink with the rhythm of music
- With a dedicated screen to display parameters precisely
- With a universal multifunctional bracket to quickly adjust different lighting angles
- With simple operation and light and thin body which offers great portability
- Various of using methods

## Warning

- ⚠ Always keep this product dry. Do not use in rain or in damp conditions.
- ⚠ Do not disassemble. Should repairs become necessary, this product must be sent to an authorized maintenance center.
- ⚠ Keep out of reach of children.
- ⚠ As this product do not have waterproof function, please take measures of waterproof in rainy or damp environment.
- ⚠ Do not use the flash unit in the presence of flammable gases, chemicals and other similar materials. In certain circumstance, these materials may be sensitive to the strong light emitting from this flash unit and fire or electromagnetic interference may result.
- ⚠ As this product has built-in lithium battery, do not disassemble, impact, squeeze or put it into fire. If serious bulge occurs, please do not use. Do not use or store the product if the ambient temperature reads over 50 °C otherwise, the lithium battery may be degraded or damaged. Please charge the product with specialized charger and correctly operate it within the defined voltage and working temperate according to the instruction manual.

#### Declaration of Conformity

GODOX Photo Equipment Co.,Ltd. hereby declares that this equipment are in compliance with the essential requirements and other relevant provisions of Directive 2014/30/EU. They are allowed to be used in all EU member states.

For more information of DoC, Please click this web link:

[http://www.godox.com/DOC/Godox\\_M1\\_DOC.pdf](http://www.godox.com/DOC/Godox_M1_DOC.pdf)

## Contents

19	Forward
20	Warning
23	Body
25	Included Items
25	Battery
26	Operation
33	Technical Data
34	Heat Protection Function
35	Maintenance

## Body

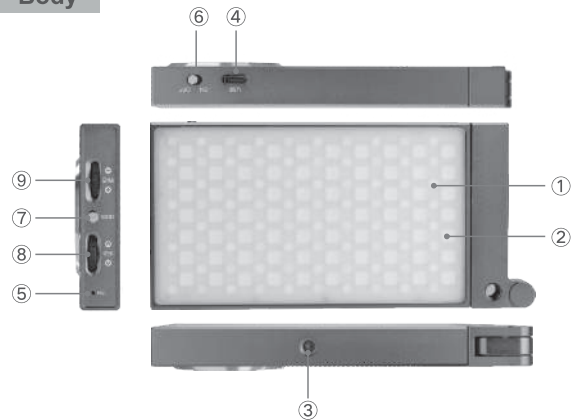

- 01. LED Beads
- 02. Diffuser
- 03. 1/4 Mounting Socket
- 04. Type-C USB Charging Port
- 05. MIC Hole
- 06. Power Switch
- 07. Mode Selection Button
- 08. FN Multifunctional Select Dial
- 09. Light Brightness Select Dial

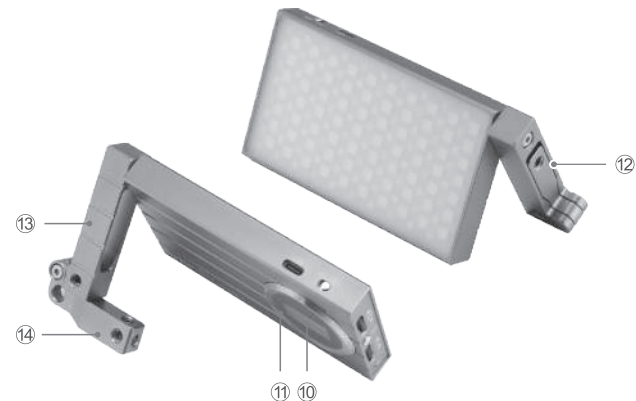

- 10. Display Screen
- 11. Color Circle
- 12. Multifunctional Bracket
- 13. Main Axis of Bracket
- 14. Inside Axis of Bracket

## Included Items



1. Light body   2. Type-C USB cable   3. Cold shoe   4. Wrench   5. Portable bag   6. Instruction manual

## Battery

1. This flash unit uses non-detachable built-in Li-ion polymer battery which has long runtime.
2. It is reliably safe. The inner circuit is against overcharge, overdischarge, overcurrent and short circuit.
3. Take approx. 2 hours to fully charge the battery through 5V/2A charger.

## Cautions

1. No over 24 hours' continuous charging.
2. Store in dry, cool, ventilated places.
3. Do not put aside or into fire.
4. Dead batteries should be disposed according to local regulations.
5. Please charge the battery to approx. 60% before being placed for long time.
6. If the battery had ceased using for over 3 months, please make a full recharge.
7. It's normal that the battery will be degraded after a period's usage for the battery life limitation.

## Operation

### 1. Light Setting

#### 1.1 Power on/off the light

Push the power switch to ON/OFF to power the light on or off.  
The LCD screen will display the current information.



### 1.2 Mode Selection: Bicolor mode/Colorful mode/Situational special effects mode

Press MOD button to switch different modes: CCT displayed on the screen means bicolor mode, HIS displayed on the screen means colorful mode and FX means situational special effects mode.



Bicolor mode



Colorful mode

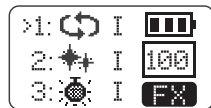

Special effects mode

**1.3 MIC:** when using music mode, please place the MIC hole closely to the music source area and adjust the distance between light and audio source according to the effects.



## 2. Bicolor Mode

**2.1 Color temperature adjustment:** turn the FN multifunctional select dial upwards or downwards to adjust the color temperature from 2500K to 8500K.

**2.2 Light brightness adjustment:** turn the light brightness select dial from 0 to 100%.



## 3. Colorful Mode

**3.1 Adjust hue H:** press the FN multifunctional select dial and H is selected. Turn the FN multifunctional select dial upwards or downwards to adjust the hue from 0 to 360°.



**3.2 Adjust saturation S:** press the FN multifunctional select dial and S is selected. Turn the FN multifunctional select dial upwards or downwards to adjust the saturation from 0 to 100.



**3.3 Adjust light brightness:** turn the light brightness select dial to adjust the brightness from 0-100%.



#### 4. FX Situational Special Effects Mode(40 kinds)

4.1 Turn the FN multifunctional select dial to choose different special effects modes from 1 to 15.







And the modes will display circularly.









4.2 After choosing the current mode, press down the FN multifunctional select dial from I, II and III.

And the modes will display circularly when keeping pressing the FN multifunctional select dial.

4.3 Adjust light brightness: turn the light brightness select dial to adjust from 0 to 100%.

4.4 There're 40 kinds of situational special effects mode which are divided into 15 categories for your choice.

No.	Display	Situation	DisplayI	DisplayII	DisplayIII
1		Colorful lights recycle	Slow speed	Medium speed	Quick speed
2		Flash	Flash	Press conference	Paparazzi
3		Laser colorful lights	Birthday party	KTV	Disco
4		Lightning	Discontinuous	Frequent	Sustainable
5		Broken bulb	Discontinuous	Frequent	Sustainable
6		TV	Slow speed	Medium speed	Quick speed

No.	Display	Situation	DisplayI	DisplayII	DisplayIII
7		Candle	Discontinuous	Frequent	Sustainable
8		Fire	Firewood	Campfire	Fire hazard
9		Firework	Brief	Continuous	Show
10		Police car	Strong flash	Frequent flash	Quick flash
11		Fire truck	Strong flash	Frequent flash	Quick flash
12		Ambulance	Strong flash	Frequent flash	
13		Music	Music I	Music II	
14		SOS			
15		Strong light (60s)			

#### Note:

1. Choose the strong light mode and press the FN multifunctional select dial to power on/off the light. The light brightness and power will up to max. in strong light mode. The duration of strong light mode is 60 seconds and the light will auto off after 60 seconds.
2. The light in strong light mode will be hot quickly for outputting high brightness. It is not recommended to use this function when the environment temperature is high. Otherwise, high temperature warning will be activated.



## 5. Multifunctional Bracket

5.1 Main axis: the rotation angle is 360°.

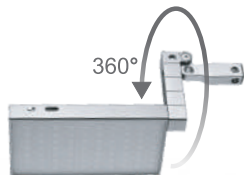

5.2 Inside axis: the rotation angle is 270°.

1. Push the main axis out firstly.



2. Push out the inside axis and rotate it with your fingers.

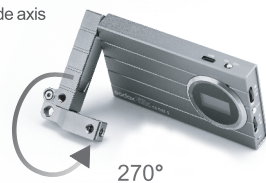

## 5.3 Using method:



1. On the table



2. On the light stand



3. Handheld



4. Cold shoe connection



5. Hang

**Note:** The bracket may be loose after thousands of rotation. Please use the included wrench to screw it tightly when the usage is affected.

## Technical Data

Model	M1
Charger(separately sold)	5V2A/18W QC3.0(5V3A,9V2A,12V1.5A)
Power	Max. 13W
Color temperature range	2500K ~ 8500K
Light brightness range	0%~100%
RGB Color gamut	0 ~ 360°(full colors)
100% Illuminance(LUX)	Max. 1700
CRI(≈)	97
TLCI(≈)	97
Bracket rotation angle	Main axis: 360° ; Inside axis: 270°
Built-in lithium battery	2410mAh

Model	M1
Duration (continuous output in 100% full power)	Approx. 150 Minutes
Operation temperature	-10~40°C
Dimension	145*70*15mm
Net weight	240g

## Heat Protection Function

To avoid damaged battery caused by overheating, a high temperature warning icon  will be displayed on the screen. And the warning icon will disappear when the temperature and the light back to normal.

## Maintenance

- Shut down the device immediately should abnormal operation be detected.
- Avoid sudden impacts and the product should be dedusted regularly.
- It is normal for the light beads to be warm when in use. Avoid continuous flashes if unnecessary.
- Maintenance of the light must be performed by our authorized maintenance department which can provide original accessories.
- This product, except consumables, is supported with a one-year warranty. Lithium battery is supported with six months warranty.
- Unauthorized service will void the warranty.
- If the product had failures or was wetted, do not use it until it is repaired by professionals.
- Changes made to the specifications or designs may not be reflected in this manual.

## FCC statement

This equipment complies with FCC radiation exposure limits set forth for an uncontrolled environment.

**A. This device complies with part 15 of the FCC Rules.** Operation is subject to the following two conditions: (1) This device may not cause harmful interference, and (2) this device must accept any interference received, including interference that may cause undesired operation.

**B. Warning:** Changes or modifications to this unit not expressly approved by the part responsible for compliance could void the user's authority to operate the equipment.

**C. NOTE:** This equipment has been tested and found to comply with the limits for a Class B digital device, pursuant to part 15 of the FCC Rules.

These limits are designed to provide reasonable protection against harmful interference in a residential installation. This equipment generates, uses and can radiate radio frequency energy and, if not installed and used in accordance with the instructions, may cause harmful interference to radio communications. However, there is no guarantee that interference will not occur in a particular installation. If this equipment does cause harmful interference to radio or television reception, which can be determined by turning the equipment off and on, the user is encouraged to try to correct the interference by one or more of the following measures:

- Reorient or relocate the receiving antenna.
- Increase the separation between the equipment and receiver.
- Connect the equipment into an outlet on a circuit different from that to which the receiver is connected.
- Consult the dealer or an experienced radio/TV technician for help.