

PIXAPRO®

G101 C

TTL Li-ion Round Head Camera Flash



INSTRUCTION MANUAL

Before using this product:

Please read this user manual carefully in order to ensure your safety and the proper operation of this product. Keep for future reference.

PIXAPRO® LTD.

Unit 5 Sterling Park
Pedmore Road

Brierley Hill

West Midlands,

DY5 1TB

Tel: 0121 552 3113

Web: www.essentialphoto.co.uk

E-mail: info@essentialphoto.co.uk

Company Registration No. 07601334

Foreword

Thank you for purchasing this product.





This GIO1-C camera flash applies to Canon EOS series cameras and is compatible with E-TTL II autoflash. With this E-TTL II compatible flash, your shooting will become simpler. You can easily achieve a correct flash exposure even in complex light-changing environments. This camera flash features:

- With round flash head to achieve soft, even and more creative light effects. It has a 2W LED modeling lamp, which can be used off the camera.
- 76Ws power output at the max step. 81 steps from 1/1 to 1/128.
- Pro 2600mAh Li-ion Battery-max. 1.5s recycle-480 full power pops.
- Fully support Canon E-TTL II camera flash. Workable as Transmitter or Receiver unit in a wireless flash group.
- Use dot-matrix LCD panel to make clear and convenient operations.
- With built-in 2.4GHz wireless remote system to support transmitting and receiving.
- Provided multiple functions, include HSS (up to 1/8000s), FEC, FEB, etc.
- Stable consistency and color temperature with good even lighting.
- Support with firmware upgrade.

⚠ Warning



- ⚠ Always keep this product dry. Do not use in rain or in damp conditions.
- ⚠ Do not disassemble. Should repairs become necessary, this product must be sent to an authorized maintenance center.
- ⚠ Keep out of reach of children.
- ⚠ Stop using this product if it breaks open due to extrusion, falling or strong hit. Otherwise, electric shock may occur if you touch the electronic parts inside it.
- ⚠ Do not fire the flash directly into the eyes (especially those of babies) within short distances. Otherwise visual impairment may occur.
- ⚠ Do not use the flash unit in the presence of flammable gases, chemicals and other similar materials. In certain circumstance, these materials may be sensitive to the strong light emitting from this flash unit and fire or electromagnetic interference may result.
- ⚠ Do not leave or store the flash unit if the ambient temperature reads over 50°C. Otherwise the electronic parts may be damaged.
- ⚠ Turn off the flash unit immediately in the event of malfunction.

Contents

01	Foreword
02	Warning
05	Name of Parts
	Body
	Control Panel
	Dot-matrix LCD Panel
	LCD Panel in Three Modes
	What's in the Box of GIO1-C Kit?
	Separately Sold Accessories
09	Battery
10	LED Modeling Lamp
10	Attaching to a Camera
10	Power Management
11	Flash Mode — E-TTL Autoflash
	 FEC (Flash Exposure Compensation)
	 FEB (Flash Exposure Bracketing)
	FEL: Flash Exposure Lock
	 High-Speed Sync
	 Second-Curtain Sync
14	M: Manual Flash
15	Multi: Stroboscopic Flash
16	Wireless Flash Shooting: Radio (2.4G) Transmission
	Wireless Settings
	Transmitter Unit's Flash OFF
	Setting the Communication Channel
	Wireless ID Settings
	Scan the Spare Channel
	ETTL: Fully Automatic Wireless Flash Shooting
	ETTL: Use the Wireless Flash Shooting of Flash Ratio
	M: Wireless Flash Shooting with Manual Flash
	Multi: Wireless Flash Shooting with Manual Flash
23	Other Applications
	Sync Triggering
	Modeling Flash
	Auto Focus Assist Beam
	Bounce Flash
	ZOOM: Setting the Flash Coverage
	Low Battery Indicator
25	C.Fn: Setting Custom Functions
26	Control with the Camera's Menu Screen
27	Protection Function
28	Technical Data
29	Troubleshooting
30	Firmware Upgrade
30	Compatible Camera Models
30	Maintenance

GIO1

Conventions used in this Manual

- This manual is based on the assumption that both the camera and camera flash's power switches are powered on.
- Reference page numbers are indicated by "p.**".
- The following alert symbols are used in this manual:
 -  The Caution symbol gives supplemental information.
 -  The Note symbol indicates a warning to prevent shooting problem.

Name of Parts

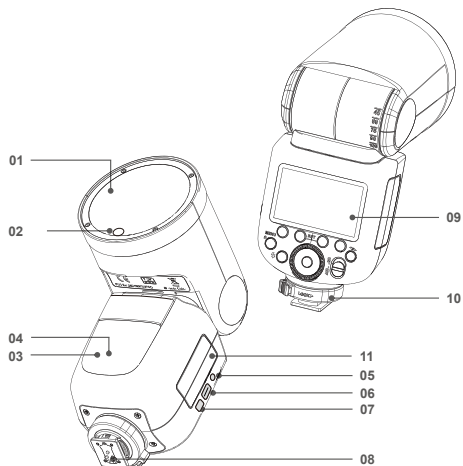

● Body

- | | |
|------------------------------|---------------------------|
| 01. Flash Head | 07. Battery Remove Button |
| 02. LED Modeling Lamp(01~10) | 08. Hotshoe |
| 03. Wireless Sensor | 09. LCD Panel |
| 04. Focus Assist Beam | 10. Hotshoe Fixing Buckle |
| 05. Sync Cord Jack | 11. Lithium Battery |
| 06. Type-C USB Port | |

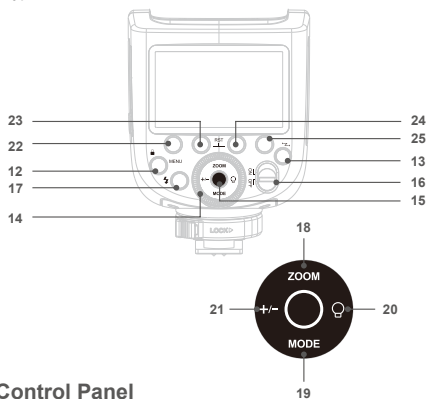

● Control Panel

- | | |
|---|---------------------------------|
| 12. <MENU>Flash Menu Button/Locking Button | 19. Setting |
| 13. <+Z> Wireless Selection Button | 20. <MODE>Mode Selection Button |
| 14. Select Dial | 21. <+/->Power Output |
| 15. Set Button | 22. Function Button 1 |
| 16. ON/OFF Power Switch | 23. Function Button 2 |
| 17. <⚡> Test Button / Flash Ready Indicator | 24. Function Button 3 |
| 18. <ZOOM> Focus Length | 25. Function Button 4 |

● LCD Panel

(1)E-TTL Autoflash

Zoom : zoom display (Page 24)

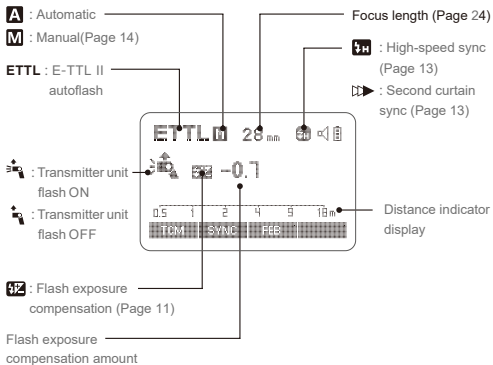

- The display will only show the settings currently applied.
- The functions displayed above function buttons 1 to 4, such as **SYNC** and <A/B/C/D>, change according to settings' status.
- When a button or dial is operated, the LCD panel illuminated.

(2)M Manual Flash

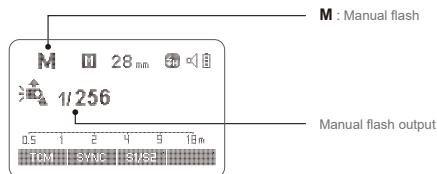

(3)Multi Flash

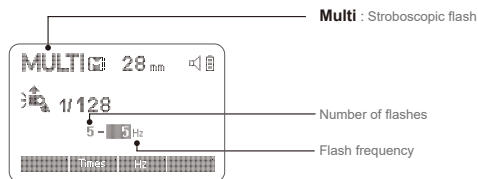

(4) Radio Transmission Shooting

● Transmitter Unit (TX)

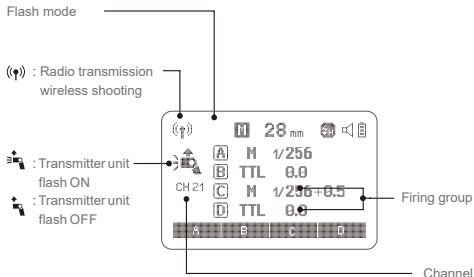

● Receiver Unit (RX)

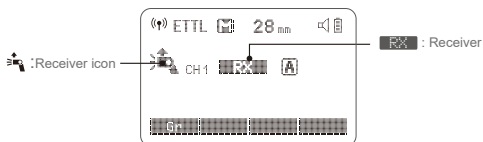

Note: The flash unit attached to the camera is referred to as the "Transmitter", and other flash units controlled wirelessly are referred to as "Receivers".

● LCD Panel in Three Modes

● Attached to the Camera

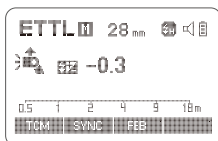

● 2.4G Radio Transmission: As a Transmitter Unit

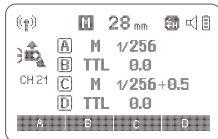

● 2.4G Radio Transmission: As a Receiver Unit



● What's in the Box of GIO1 C

1. Flash Unit
2. Lithium Battery
3. USB Battery Charger
4. USB Line
5. Charger
6. Mini Stand
7. Protection Case



● Separately Sold Accessories

The product can be used in combination with the following accessories sold separately, so as to achieve best photography effects:

ST-IV & ST-III TTL wireless flash trigger, AK-R1 accessory kit for round flash head, etc.

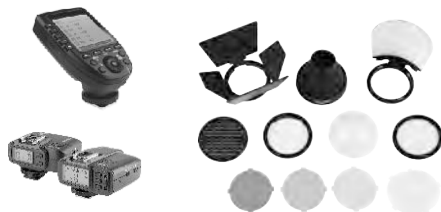

Battery

● Features

1. This flash unit uses Li-ion polymer battery which has long runtime. The available charge-and-discharge times are 500.
2. It is reliably safe. The inner circuit is against overcharge, overdischarge, overcurrent, and short circuit.
3. Take only 3.5 hours to fully charge the battery by using the standard battery charger.

● Cautions

1. Do not short circuit.
2. Do not expose to rain or immerse into water. This battery is not water proof.
3. Keep out of reach of children.
4. No over 24 hours' continuous charging.
5. Store in dry, cool, ventilated places.
6. Do not put aside or into fire.
7. Dead batteries should be disposed according to local regulations.
8. If the battery had ceased using for over 3 months, please make a full recharge.

● Loading and Unloading the Battery

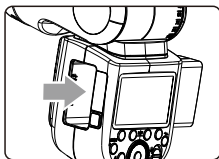

- 1 To unload the battery, hold down the battery remove button and push the battery downwardly to take it out.

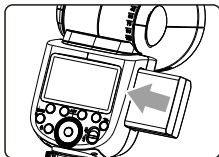

- 2 According to the triangle sign on the battery pack, insert it into the compartment until a white knob locks the battery with a click sound.

● Battery Level Indication

Make sure the battery pack is securely loaded in the flash. Check the battery level indication on the LCD panel to see the remaining battery level.

Battery Level Indication	Meaning
3 grids	Full
2 grids	Middle
1 grid	Low
Blank grid	Lower battery, please recharge it.
Blinking	The battery level is going to be used out immediately. And the flash will auto power off in 1 minute. Note: Please recharge the battery as soon as possible (within 10 days). Then, the battery can be used or be placed for long period.

LED Modeling Lamp

Press the Modeling Lamp Setting button to set the modeling lamp. Short press the Set Button to turn on or off the modeling lamp. When turning the modeling lamp on, turn the select dial to set its brightness. There are 10 levels(01~10) for choice.

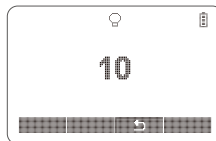

Attaching to a Camera



- 1 Attach the Camera Flash.
 - Rotate the hotshoe fixing buckle to the left and insert the camera flash into the camera's hotshoe.



- 2 Secure the Camera Flash.
 - Rotate the hotshoe fixing buckle to the right until it locks up.



- 3 Detach the Camera Flash.
 - Press the button and rotate the hotshoe fixing buckle to the left until it is loosened.

Power Management

Use ON/OFF Power Switch to power the flash unit on or off. Turn off if it will not be used for an extended period of time. Setting as a transmitter flash, it will turn the power off automatically after a certain period (approx. 90 seconds) of idle use. Pressing the camera shutter halfway or pressing any flash button will wake up the flash unit. Setting as a receiver flash, it will enter sleep mode after a certain period (adjustable, 60 minutes by default) of idle use. Pressing any flash button will wake it up.

- C.Fn** Disabling Auto Power Off function is recommended when the flash is used off camera. (C.Fn-STBY, Page 25)
- C.Fn** Receiver Auto Power Off Timer is set to 60 minutes by default. Another option "30 minutes" is available. (C.Fn-RX STBY, Page 25)

Flash Mode—E-TTL Autoflash

This flash has three flash modes: **E-TTL**, **Manual (M)**, and **Multi** (Stroboscopic). In **E-TTL** mode, the camera and the flash will work together to calculate the correct exposure for the subject and the background. In this mode, multiple TTL functions are available: **FEC**, **FEB**, **FEL**, **HSS**, second curtain sync, modeling flash, control with the camera's menu screen.

* Press **<MODE>** Mode Selection Button and three flash modes will display on the LCD panel one by one with each pressing.

E-TTL Mode

Press **<MODE>** Mode Selection Button to enter E-TTL mode. The LCD panel will display.

- Press the camera release button halfway to focus. The aperture and effective flash range will be displayed in the viewfinder.
- When the shutter button is fully pressed, the flash will fire a pre-flash that the camera will use to calculate exposure and flash output the instant before the photo is taken.

FEC: Flash Exposure Compensation

With **FEC** function, this flash can adjust from -3 to +3 in 1/3rd stops. It is useful in situations where minor adjusting of the TTL system is needed based on the environment.

Setting FEC:

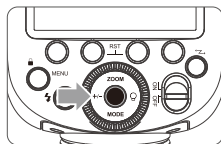

- 1** Press Function **Button 2**. Press the **<+/->** button. The icon **< +/- >** and flash exposure compensation amount will be highlighted on the LCD panel.

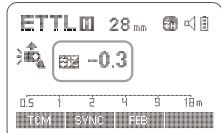

- 2** Set the flash exposure compensation amount.
 - Turn the Select Dial to set the amount.
 - "0.3" means 1/3 step, "0.7" means 2/3 step.
 - To cancel the flash exposure compensation, set the amount to "+0".

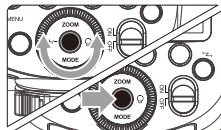

- 3** Press Set Button again to confirm the setting.

FEB: Flash Exposure Bracketing

You can take three flash shots while automatically changing the flash output for each shot from -3 to +3 in 1/3rd stops. The camera will record three images with different exposures: one exposed according to camera calculations, one over-exposed and another under-exposed. Over and under exposure amount is user adjustable. This function helps get correct exposure especially in shooting moving objects or when environmental lights are complex.

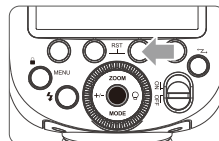

- 1** Press function button **3** **< FEB >**. The icon **< FEB >** and the exposure bracketing amount will be highlighted on the LCD panel.

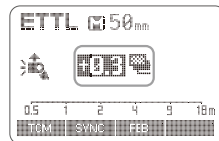

- 2** Set the flash exposure compensation amount.
 - Turn the Select Dial to set the amount.
 - "0.3" means 1/3 step, "0.7" means 2/3 step.

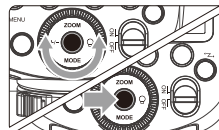

- 3** Press Set Button again to confirm the setting. Then your **FEC** and **FEB** settings are displayed on the LCD panel.

- FEB will be cancelled after three photos are taken.
- For best results, set the camera drive mode to "single" and ensure the flash is ready before shooting.
- FEB can be used with **FEC** and **FEL**.
- C.Fn** You can prevent the FEB from being cancelled automatically after three photos are taken. (C.Fn-FEB ACL, Page 25)

FEL: Flash Exposure Lock

FEL can lock the correct flash exposure setting for any part of the scene.

With **<ETTL>** displayed on the LCD panel, press the camera's **<FEL>** button. If the camera does not have the **<FEL>** button, press the **<* >** button.

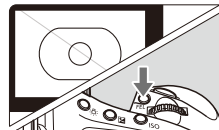

- 1** Focus the subject.
- 2** Press the **<FEL>** button.
 - Aim the subject at the center of the viewfinder and press **<FEL>** button.
 - The camera flash will fire a preflash and the required flash output for the subject is retained in memory.
 - Each time the **<FEL>** button is pressed, a preflash will be fired and a new flash exposure setting will be locked.

- If the subject is too far away and underexposure, the <↓> icon will blink in the viewfinder. Move closer to the subject and try the FE lock again.
- If <ETTL> is not displayed on the LCD panel, FE lock cannot be set.
- If the subject is too small, FE lock might not be very effective.

High-Speed Sync

High Speed Sync (FP flash) enables the flash to synchronize with all camera shutter speeds. This is convenient when you want to use aperture priority for fill-flash portraits.

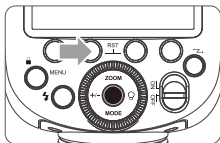

- 1 Press Function Button 2 <SYNC> so that <H> is displayed.

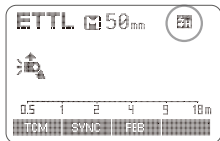

- 2 Check that <H> is displayed in the viewfinder.

- If you set a shutter speed that is the same as or slower than the camera's maximum flash sync speed, <H> will not be displayed in the viewfinder.
- With high-speed sync, the faster the shutter speed, the shorter the effective flash range.
- To return to normal flash, press <SYNC> button again. Then <H> will disappear.
- Multi flash mode cannot be set in high-speed sync mode.
- Over-temperature protection may be activated after 15 consecutive high-speed sync flashes.

Second-Curtain Sync

With a slow shutter speed, you can create a light train following the subject. The flash fires right before the shutter closes.

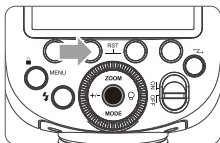

- Press function button 2 <SYNC> button so that <⇨> is displayed on the LCD panel.

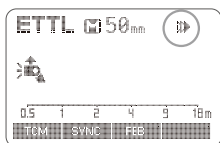

M: Manual Flash

The flash output is adjustable from 1/1 full power to 1/256th power in 1/10th stop increments. To obtain a correct flash exposure, use a hand-held flash meter to determine the required flash output.

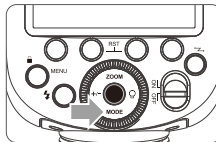

- 1 Press <MODE> button so that <M> is displayed.

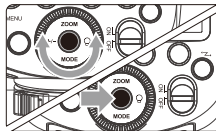
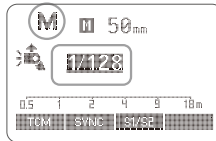

- 2 Turn the Select Dial to choose a desired flash output amount.
- 3 Press Set Button again to confirm the setting.

Optic S1 Secondary Unit Setting

In M manual flash mode, press <S1/S2> button so that this flash can function as an optic S1 secondary flash with optic sensor. With this function, the flash will fire synchronously when the main flash fires, the same effect as that by the use of radio triggers. This helps create multiple lighting effects.

Optic S2 Secondary Unit Setting

Press <S1/S2> button so that this flash can also function as an optic S2 secondary flash with optic sensor in M manual flash mode. This is useful when cameras have pre-flash function. With this function, the flash will ignore a single "pre-flash" from the main flash and will only fire in response to the second, actual flash from the main unit.

- S1 and S2 optic triggering is only available in M manual flash mode.

Multi: Stroboscopic Flash

With stroboscopic flash, a rapid series of flashes is fired. It can be used to capture a multiple images of a moving subject in a single photograph.

You can set the firing frequency (number of flashes per sec. expressed as Hz), the number of flashes, and the flash output.

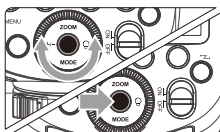
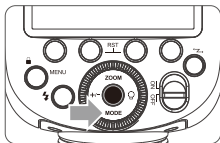

- 1 Press <MODE> button so that <MULTI> is displayed.
- 2 Set the flash frequency and flash times.
 - Press the Function Button 2 <Times> to select the flash times. Turn the Select Dial to set the number.
 - Press the Function Button 3 <Hz> to select the flash frequency. Turn the Select Dial to set the number.
- 3 Turn the Select Dial to choose a desired flash output.
 - After you finish the setting, press Set Button and all the settings will be displayed.

Calculating the Shutter Speed

During stroboscopic flash, the shutter remains open until the firing stops. Use the formula below to calculate the shutter speed and set it with the camera.

Number of Flashes / Flash Frequency = Shutter Speed

For example, if the number of flashes is 10 and the firing frequency is 5 Hz, the shutter speed should be at least 2 seconds.

- ⚠ To avoid overheating and deteriorating the flash head, do not use stroboscopic flash more than 10 times in succession. After 10 times, allow the camera flash to rest for at least 15 minutes. If you try to use the stroboscopic flash more than 10 times in succession, the firing might stop automatically to protect the flash head. If this happens, allow at least 15 minutes' rest for the camera flash.

- 📌 • Stroboscopic flash is most effective with a highly reflective subject against a dark background.
- Using a tripod and a remote control is recommended.
- A flash output of 1/1 and 1/2 cannot be set for stroboscopic flash.
- Stroboscopic flash can be used with "buLb".
- If the number of flashes is displayed as "--", the firing will continue until the shutter closes or the battery is exhausted. The number of flashes will be limited as shown by the following table.

Maximum Stroboscopic Flashes:

Flash output \ Hz	1	2	3	4	5	6-7	8-9
1/4	8	6	4	3	3	2	2
1/8	14	14	12	10	8	6	5
1/16	30	30	30	20	20	20	10
1/32	60	60	60	50	50	40	30
1/64	90	90	90	80	80	70	60
1/128	100	100	100	100	100	90	80
1/256	100	100	100	100	100	90	80

Flash output \ Hz	10	11	12-14	15-19	20-50	60-199
1/4	2	2	2	2	2	2
1/8	4	4	4	4	4	4
1/16	8	8	8	8	8	8
1/32	20	20	20	18	16	12
1/64	50	40	40	35	30	20
1/128	70	70	60	50	40	40
1/256	70	70	60	50	40	40

Wireless Flash Shooting: Radio (2.4G) Transmission

- ⚠ • When the camera's shooting mode is set to a fully automatic mode or an Image Zone mode, the operations in this chapter are not available. Set the camera's shooting mode to P/Tv/Av/M/B (Creative Zone Mode).
- 📌 • The GIO1-C attach to the camera is called the transmitter unit, and a GIO1-C that is wirelessly controlled is called the receiver unit.
 - You can also wirelessly control the GIO1-C set as the receiver unit with the transmitter X1T-C (sold separately). For details on setting the transmitter unit functions, see the transmitter's instructions.

Using a flash (transmitter/receiver) with a radio transmission wireless shooting function make it easy to shoot with advanced wireless multiple flash lighting, in the same way as E-TTL II autoflash shooting.

The basic relative position and operation range are as shown in the picture. You can then perform wireless E-TTL II autoflash shooting just by setting the transmitter unit to <ETTL>.

Positioning and Operation Range (Example of wireless flash shooting)

● Autoflash Shooting with One Receiver Unit

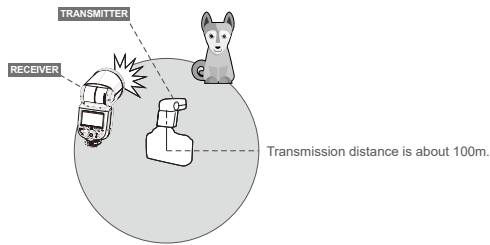

- Use the supplied mini stand to position the Receiver unit.
- Before shooting, perform a test flash and test shooting.
- The transmission distance might be shorter depending on the conditions such as positioning of Receiver units, the surrounding environment and whether conditions.

Wireless Multiple Flash Shooting

You can divide the Receiver units into two or three groups and perform E-TTL II autoflash while changing the flash ratio (factor). In addition, you can set and shoot with a different flash mode for each firing group, for up to 4 groups.

● Auto Shooting with Two Receiver Groups

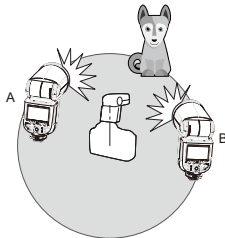

● Auto Shooting with Three Receiver Groups

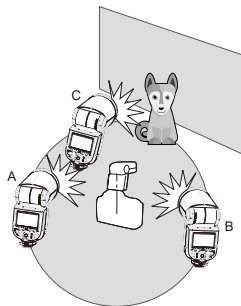

● Shooting with a Different Flash Mode set for Each Group

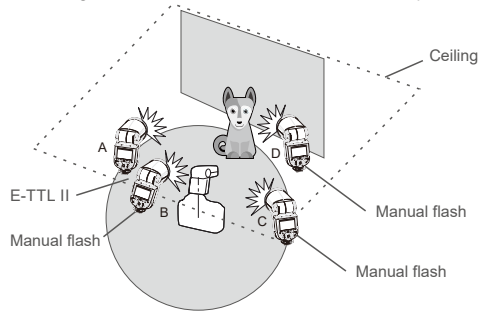

* The flash mode settings are indicated only as an example

1. Wireless Settings

You can switch between normal flash and wireless flash. For normal flash shooting, be sure to set the wireless setting to OFF.

Transmitter Unit Setting

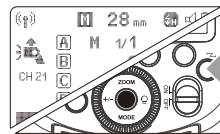

Press < > button so that < > is displayed on the LCD panel.

Receiver Unit Setting

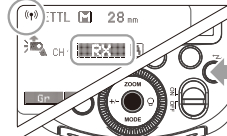

Press < > button so that < > or < > are displayed on the LCD panel.

2. Transmitter Unit's Flash OFF

When the Transmitter unit is set to OFF, only the Receiver units will fire a flash.

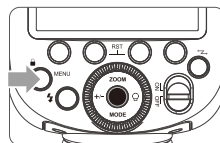

1 Press <MENU> Button to enter C.Fn Transmitter setting.

2 Set Transmitter to ON/OFF to control the On/Off of the Transmitter unit.

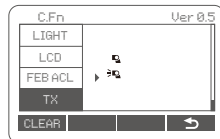

< >: The Transmitter unit flash firing is ON.

< >: The Transmitter unit flash firing is OFF.

- Even if the Transmitter unit flash firing is disabled, it still fires a preflash to transmit wireless signals.

3. Setting the Communication Channel

If there are other wireless flash systems nearby, you can change the channel IDs to prevent signal interference. The channel IDs of the Transmitter unit and the Receiver unit(s) must be set to the same.

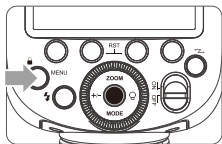

- 1 Press <MENU> Button to enter C.Fn CH setting.

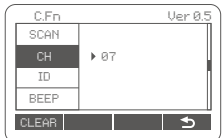

- 2 In C.Fn CH, turn the Select Dial to choose channel ID from 1 to 32.

- 3 Press the Set Button to confirm.

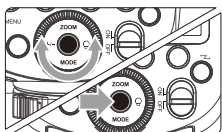

2 Receiver Unit Setting

- Set the other camera flash as the wireless Receiver Unit.

3 Check the communication channel.

- If the Transmitter unit and Receiver unit(s) are set to a different channel, set them to the same channel. (Page 19)

4 Position the camera and flashes.

- Position the camera and flashes as the picture shows. (Page 17)

5 Set the Transmitter unit's flash mode to <ETTL>.

- Set the Transmitter unit's flash mode to <ETTL>.
- For shooting, <ETTL> will automatically be set for the Receiver unit.
- Set the Transmitter unit flash firing as ON to fire a flash.

6 Check that the flash is ready.

- Check that the Transmitter flash ready indicator is lightened.
- When the Receiver flash ready indicator is ready, the AF-assist beam lighting area will blink at 1 second intervals.

7 Check the flash operation.

- Press the Transmitter unit's Test Button <4>.
- Then, the Receiver unit will fire. If not, adjust the Receiver unit's angle toward the Transmitter unit and distance from the Transmitter unit.

4. Wireless ID Settings

Change the wireless channels and wireless ID to avoid interference for it can only be triggered after the wireless IDs and channels of the Transmitter unit and the Receiver unit are set to the same. Press the <MENU> button to enter C.Fn ID. Press the Set Button to choose OFF channel expansion shutdown, and choose any figure from 01 to 99.

5. Scan the Spare Channel

To avoid the interference of using the same channel by others, this function can be used: enter the C.Fn settings and find the SCAN option. When setting it to START, it will scan from 1% to 100%. And the 8 spare channels will be displayed after the scan is completed.

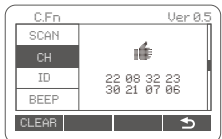

6. E TTL: Fully Automatic Wireless Flash Shooting

Using Automatic Wireless Flash with a Single Receiver Unit

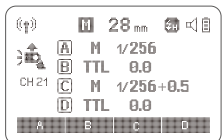

1 Transmitter Unit Setting

- Attach a GIO1-C camera flash on the camera and set it as the Transmitter unit.
- X1T-C can also be used as Transmitter unit. X1T-C can control GIO1-C's ZOOM value when the ZOOM is adjusted to auto (A) mode.

Using Automatic Wireless Flash with Multiple Receiver Units

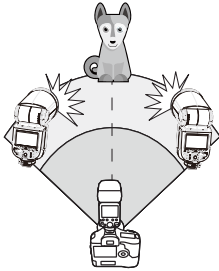

When stronger flash output or more convenient lighting operation is needed, increase the number of Receiver units and set it as a single Receiver unit.

To add Receiver units, use the same steps as setting "automatic wireless flash with a single Receiver unit". Any flash group can be set (A/B/C/D/E).

When the number of Receiver units is increased and the Transmitter unit flash firing is ON, automatic control is implemented to make all groups of flashes fire the same flash output and ensure the total flash output up is to standard exposure.

- Press the depth-of-field preview button on the camera to fire a modeling flash.
- If the Receiver unit's auto power off function is workable, press the Transmitter unit's test button to power it on. Please note that test firing is unavailable during the camera's regular metering time.
- The effective time of Receiver auto power off is changeable. (C.Fn-RX STBY Page 25)
- By making some settings, the auto AF-assist transmitter will not blink after the Receiver unit's flash ready indicator is lightened. (C.Fn-AF Page 25)

Using Fully Automatic Wireless Flash

The FEC and other settings that set on the Transmitter unit will also be appeared on the Receiver unit automatically. The Receiver unit does not need any operation. Use the following settings to make wireless flashes according to the same methods with normal flash shooting.

- Flash Exposure Compensation (Page 11)
- Flash Exposure Lock (Page 12)
- Manual Flash (Page 14)
- Stroboscopic Flash (Page 15)

About Transmitter Unit

Use two or more Transmitter units. By preparing several cameras that with Transmitter units flash attached, cameras can be changed in shooting while keeping the same lighting source (Receiver unit).

7. M: Wireless Flash Shooting with Manual Flash

This describes wireless (multiple shooting) using manual flash. You can shoot with a different flash output setting for each Receiver unit (firing group). Set all parameters on the Transmitter unit.

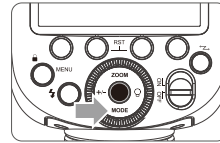

- 1 Setting the flash mode to <M>.

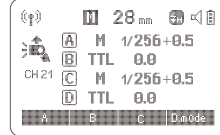

- 2 Setting flash output.1/2/3/4<A/B/C/D>
 - Press Function Button 3 < Gr >. Turn the Select Dial to set the flash output of the groups. Press Set Button to confirm.

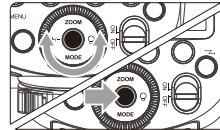

- 3 Taking the picture.
 - Each group fires at the set flash ratio.

Setting <M> Flash Mode

You can directly operate the Receiver unit to manually set the manual flash or stroboscopic flash.



- 1 Setting the Receiver unit.
- 2 Setting flash mode to <M>.
 - Press <MODE> button so that <M> is displayed.
 - Set the manual flash output. (Page 14)

8. Multi: Wireless Flash Shooting with Manual Flash

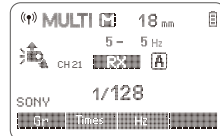

Setting <MULTI> stroboscopic flash.

- Press <MODE> button so that <MULTI> is displayed.
- Setting the stroboscopic flash. (Page 15)

Other Applications

Sync Triggering

The Sync Cord Jack is a $\Phi 2.5\text{mm}$ plug. Insert a trigger plug here and the flash will be fired synchronously with the camera shutter.

Modeling Flash

If the camera has a depth-of-field preview button, pressing it will fire the flash continuously for 1 second. This is called modeling flash. It enables you to see the shadow effects on the subject and the lighting balance. You can fire the modeling flash during wireless or normal flash shooting.

- ⚠ To avoid overheating and deteriorating the flash head, do not fire the modeling flash for more than 10 consecutive times. If you fire the modeling flash 10 consecutive times, allow at least 10 minutes' break for the camera flash.
- The modeling flash cannot be fired with the EOS 300 and Type-B cameras.

Auto Focus Assist Beam

In poorly-lit or low-contrast shooting environments, the built-in auto focus assist beam will automatically light on to make it easier for autofocus. The beam will light up only when autofocus is difficult and get out as soon as the autofocus becomes correct.

If you want to turn off the auto focus assist beam, set the "AF" to "OFF" on the C.Fn settings.

- 🔦 • If you find the auto focus assist beam does not light up, this is because the camera has got a correct autofocus.

Position	Effective Range
Center	0.6~10m / 2.0~32.8 feet
Periphery	0.6~5m / 2.0~16.4 feet

Bounce Flash

By pointing the flash head toward a wall or ceiling, the flash will bounce off the surface before illuminating the subject. This can soften shadows behind the subject for a more natural-looking shot. This is called bounce flash.

To set the bounce direction, hold the flash head and turn it to a satisfying angle.

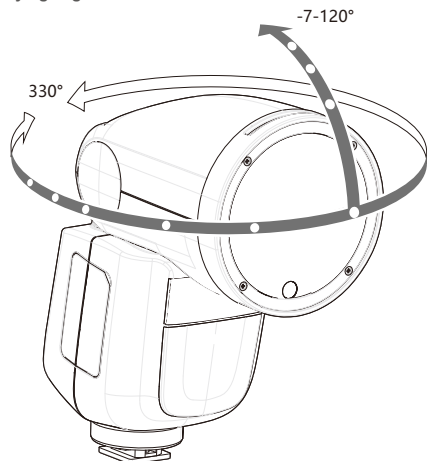

- 🔦 • If the wall or ceiling is too far away, the bounced flash might be too weak and result in underexposure.
- The wall or ceiling should be a plain, white color for high reflectance. If the bounce surface is not white, a color cast may appear in the picture.

ZOOM: Setting the Flash Coverage

The flash coverage can be set automatically or manually. It can be set to match the lens focal length from 28mm to 105mm.

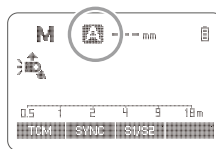

In Manual Zoom mode, press the <ZOOM> button.

- Turn the Select Dial to change the flash coverage.
- If <A> is displayed, the flash coverage will be set automatically.

- 🔦 • If you set the flash coverage manually, make sure it covers the lens focal length so that the picture will not have a dark periphery.

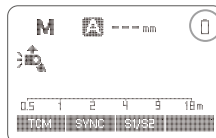



Low Battery Warning

If the battery power is low, < > will appear and blink on the LCD panel. Please replace the battery immediately.

C.Fn: Setting Custom Functions

The following table lists the available and unavailable custom functions of this flash.

C.Fn Custom Functions			
Custom Function Signs	Function	Setting No	Settings & Description
m/ft	Distance indicator	m	m
		ft	feet
AF	AF-assist beam	ON	ON
		OFF	OFF
STBY	Auto sleep setting	ON	ON
		OFF	OFF
RX STBY	Receiver auto power off timer	60min	60min
		30min	30min
SCAN	Scan the spare channel	OFF	OFF
		START	Start to find the spare channel
CH	Channel setting	01-32	Choose channels from 01-32
ID	Wireless ID	OFF	Off
		01-99	Choose any figure from 01-99
BEEP	Beeper	ON	ON
		OFF	OFF
LIGHT	Backlighting time	12sec	Off in 12 sec.
		OFF	Always off
		ON	Always lighting
LCD	LCD contrast ratio	-3~+3	7 levels
FEB ACL	FEB auto cancel	ON	ON
		OFF	OFF
TX	Transmitter unit control		OFF
			ON

- Press <MENU> Button until C.Fn menu is displayed. The “Ver x.x” in the top-right corner refers to the software version.
- Select the Custom Function No.
 - Turn the Select Dial to select the Custom Function No.
- Change the Setting.
 - Press Set Button and the Setting No. blinks.
 - Turn the Select Dial to set the desired number. Pressing Set Button will confirm the settings.
 - After you set the Custom Function and press <MENU> button, the camera will be ready to shoot.
- In the C.Fn states, long press the “Clear” button for 2 seconds until “OK” is displayed on the panel, which means the values in C.Fn can be reset.

Control with the Camera’s Menu Screen

If the camera flash is attached to an EOS camera which has a speedlite control function, the flash can be controlled using the camera’s menu screen. For the menu operation procedure, refer to your camera’s instruction manual.

● Setting Camera Flash Functions

The following flash functions are settable according to different flash modes.

- Flash mode
- Shutter sync (1st/2nd curtain, high speed sync)
- FEB
- Flash exposure compensation
- Flash firing
- Clear camera flash’s settings

● Custom Functions of Camera Flash

C.Fn-00, C.Fn-01, C.Fn-03, C.Fn-08, C.Fn-10, C.Fn-20, C.Fn-22.

Clear All Flash Custom Functions

Flash function settings screen

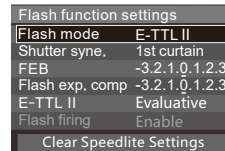

Flash C.Fn settings screen

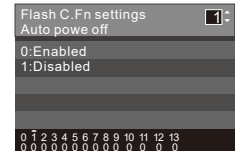

* Screens from the EOS-1D Mark III.

- If flash exposure compensation has already been set with the camera flash, flash exposure compensation cannot be set with the camera. To set it with the camera, the camera flash’s flash exposure compensation must be set to zero.
- If any Flash Custom Functions and flash settings other than flash exposure compensation have been set by both the camera and the flash, the latest settings will take effect.

Protection Function

1. Over-Temperature Protection

- To avoid overheating and deteriorating the flash head, do not fire more than 30 continuous flashes in fast succession at 1/1 full power. After 30 continuous flashes, allow a rest time of at least 10 minutes.
- If you fire more than 30 continuous flashes and then fire more flashes in short intervals, the inner over-temperature protection function may be activated and make the recycling time over 10 seconds. If this occurs, allow a rest time of about 10 minutes, and the flash unit will then return to normal.
- When the over-temperature protection is started,  is shown on the LCD display.

Number of flashes that will activate over-temperature protection:

Power Output Level	Number of Flashes
1/1	30
1/2 +0.7	40
1/2 +0.3	50
1/2	60
1/4(+0.3,+0.7)	100
1/8(+0.3,+0.7)	200
1/16(+0.3,+0.7)	300
1/32(+0.3,+0.7)	500
1/64(+0.3,+0.7)	1000
1/128(+0.3,+0.7)	

Number of flashes that will activate over-temperature protection in high-speed sync triggering mode:

Power Output	Times
1/1	15
1/2(+0.3,+0.7);	20
1/4(+0.3,+0.7)	30
1/8(+0.3,+0.7);	40
1/16(+0.3,+0.7)	
1/32(+0.3,+0.7);	
1/64(+0.3,+0.7);	50
1/128(+0.3,+0.7);	

2. Other Protections

The system provides real-time protection to secure the device and your safety. The following lists prompts for your reference:

Prompts on LCD Panel	Meaning
E1	A failure occurs on the recycling system so that the flash cannot fire. Please restart the flash unit. If the problem still exists, please send this product to a maintenance center.
E2	The system gets excessive heat. Please allow a rest time of 10 minutes.
E3	The voltage on two outlets of the flash tube is too high. Please send this product to a maintenance center.
E9	There are some errors occurred during the upgrading process. Please using the correct firmware upgrade method.





Technical Data

Model	GI01-C
Compatible Cameras	Canon EOS cameras (E-TTL II autofocus)
Power (1/1 output)	76Ws
Flash Coverage	28 to 105mm <ul style="list-style-type: none"> • Auto zoom (Flash coverage set automatically to match the lens focal length and image size) • Manual zoom • Swinging/tilting flash head (bounce flash): 0 to 330° horizontally and -7° to 120° vertically
Flash Duration	1/300 to 1/20000 seconds
• Exposure Control	
Exposure control system	E-TTL II autofocus and manual flash
Flash exposure compensation (FEC)	Manual. FEB: ±3 stops in 1/3 stop increments (Manual FEC and FEB can be combined.)
FE lock	With <FEL> button or < * > button
Sync mode	High-speed sync (up to 1/8000 seconds), first-curtain sync, and second-curtain sync
Multi flash	Provided (up to 100 times, 199Hz)
• Wireless Flash	
Wireless flash function	Transmitter, Receiver, Off
Transmitter groups	A, B, C, D
Controllable Receiver groups	A, B, C, D, E (E group can be controlled by X series flash trigger)
Transmission range (approx.)	100m
Channels	32 (1~32)
ID	01~99
Modeling flash	Fired with camera's depth-of-field preview button
• Auto Focus Assist Beam	
Effective range (approx.)	Center: 0.6~10m / 2.0~32.8 feet Periphery: 0.6~5m / 2.0~16.4 feet
• LED Modeling Lamp	
Power	2W
Color Temperature	3300K±200K
• Power Supply	
Power source	7.2V/2600mAh Li-ion battery
Recycle time	Approx 1.5 seconds. Green LED indicator will light up when the flash is ready.
Full power flashes	Approx. 480
Power saving	Power off automatically after approx. 90 seconds of idle operation. (60 minutes if set as Receiver)
• Sync Triggering Mode	
• Dimensions	
W x H x D	76*93*197mm
Weight without battery	420g
Weight with battery	530g
2.4G Wireless Frequency Range	2413.0MHz-2464.5MHz
Max. Transmitting Power of 2.4G Wireless	5dbm

Troubleshooting

If there is a problem, refer to this Troubleshooting Guide.

The Camera Flash does not fire.

- The camera flash is not attached securely to the camera.
→ Attach the camera's mounting foot securely to the camera.
- The electrical contacts of the Camera Flash and camera are dirty.
→ Clean the contacts.
- <  > or <  H > is not displayed in the view finder of camera.
→ Wait until the flash is fully recycled and the flash ready indicator lights up.
→ If the flash ready indicator lights up, but <  > or <  H > is not displayed in the view finder, check whether this flash unit is securely attached to the camera hotshoe.
→ If the flash ready indicator does not light up after a long wait, check whether the battery power is enough. If the battery power is low, <  > will appear and blink on the LCD panel. Please replace the battery immediately.

The power turns off by itself.

- After 90 seconds of idle operation, auto power off took effect if the flash is set as Transmitter.
→ Press the shutter button halfway or press any flash button to wake up.
- After 60 minutes (or 30 minutes) of idle operation, the flash unit will enter sleep mode if it is set as Receiver.
→ Press any flash button to wake up.

Auto zoom does not work.

- The camera flash is not attached securely to the camera.
→ Attach the camera flash's mounting foot to the camera.

The flash exposure is underexposed or overexposed.

- There was a highly reflective object (e.g. glass window) in the picture.
→ Use FE lock (FEL).
- You used high-speed sync.
→ With high-speed sync, the effective flash range will be shorter. Make sure the subject is within the effective flash range displayed.
- You used Manual Flash mode.
→ Set the flash mode to E TTL or modify the flash output.

Photos have dark corners or only parts of the target subject are illuminated.

- The focal length of lens exceeds the flash coverage.
→ Check the flash coverage you set. This flash unit has the flash coverage between 28 and 105mm, which fits medium-format cameras.

Firmware Upgrade

- The USB port is a Type-C USB socket. Type-C USB connection line is applicable.
- As the firmware upgrade needs the support of PIXAPRO G3 software, please download and install the "PIXAPRO G3 firmware upgrade software" before upgrading. Then, choose the related firmware file.
- As the product needs to do firmware upgrade, please refer to instruction manual of the newest electric version as final.

Compatible Camera Models

This flash unit can be used on the following **Canon EOS series camera models**:

1DX	5D Mark III	5D Mark II	6D	7D	60D	50D	40D	30D
650D	600D	550D	500D	450D	400D Digital	1100D	1000D	
5D Mark IV	7D Mark II	6D Mark II	760D	750D	70D	80D		
800D	77D	M5	M3	M50	EOS R	1500D	3000D	

 This table only lists the tested camera models, not all Canon EOS series cameras. For the compatibility of other camera models, a self-test is recommended. Rights to modify this table are retained.

Maintenance

- Shut down the device immediately should abnormal operation be detected.
- Avoid sudden impacts and the product should be dedusted regularly.
- It is normal for the flash tube to be warm when in use. Avoid continuous flashes if unnecessary.
- Maintenance of the flash must be performed by our authorized maintenance department which can provide original accessories.
- This product, except consumables e.g. flash tube, is supported with a one-year warranty.
- Unauthorized service will void the warranty.
- If the product had failures or was wetted, do not use it until it is repaired by professionals.
- Changes made to the specifications or designs may not be reflected in this manual.

FCC Warning

This device complies with part 15 of the FCC Rules. Operation is subject to the following two conditions: (1) This device may not cause harmful interference, and (2) this device must accept any interference received, including interference that may cause undesired operation.

Any Changes or modifications not expressly approved by the party responsible for compliance could void the user's authority to operate the equipment.

Note: This equipment has been tested and found to comply with the limits for a Class B digital device, pursuant to part 15 of the FCC Rules. These limits are designed to provide reasonable protection against harmful interference in a residential installation. This equipment generates uses and can radiate radio frequency energy and, if not installed and used in accordance with the instructions, may cause harmful interference to radio communications. However, there is no guarantee that interference will not occur in a particular installation. If this equipment does cause harmful interference to radio or television reception, which can be determined by turning the equipment off and on, the user is encouraged to try to correct the interference by one or more of the following measures:

- ▶ Reorient or relocate the receiving antenna.
- ▶ Increase the separation between the equipment and receiver.
- ▶ Connect the equipment into an outlet on a circuit different from that to which the receiver is connected.
- ▶ Consult the dealer or an experienced radio/TV technician for help.

***RF warning:**

This equipment complies with FCC radiation exposure limits set forth for an uncontrolled environment.

IC statement:

This device complies with Industry Canada licence-exempt RSS standard(s).

Operation is subject to the following two conditions: (1) this device may not cause interference, and (2) this device must accept any interference, including interference that may cause undesired operation of the device.

Le présent appareil est conforme aux CNR d'Industrie Canada applicables aux appareils radio exempts de licence. L'exploitation est autorisée aux deux conditions suivantes : (1) l'appareil ne doit pas produire de brouillage, et (2) l'utilisateur de l'appareil doit accepter tout brouillage radioélectrique subi, même si le brouillage est susceptible d'en compromettre le fonctionnement.

:

This equipment complies with Industry Canada radiation exposure limits set forth for an uncontrolled environment.

Cet équipement est conforme à l'exposition aux rayonnements Industry Canada limités établies pour un environnement non contrôlé.