

## PIXAPRO设计文件图注

项目类型	<input type="checkbox"/> 彩盒 <input type="checkbox"/> 彩卡 <input type="checkbox"/> 白盒 <input type="checkbox"/> 贴纸 <input checked="" type="checkbox"/> 说明书 <input type="checkbox"/> 内托 <input type="checkbox"/> 胶盒 <input type="checkbox"/> 吸塑 <input type="checkbox"/> 其他:		
项目名称	PIXAPRO_Li-ion580III M 说明书		
产品料号	705-V85030-00	版本	A
展开尺寸(mm)		成品尺寸(mm)	80x195mm
尺寸公差	±2mm		
材质	105g铜版纸单色印刷		
工艺说明	骑马钉		
备注/色值			
设计师	陈正丰	校对	杨入人

705-V85030-00

# PIXAPRO®

## Li-ion580III M

Pioneering Li-ion Camera Flash



INSTRUCTION MANUAL

### PIXAPRO Ltd.

UNIT 5 Sterling Park  
Padmore Road  
Birreley Hill  
West Midlands  
DY5 1TB

Tel: +44 (0)121 552 3113  
E-mail: [info@essentialphoto.co.uk](mailto:info@essentialphoto.co.uk)

[essentialphoto.co.uk](http://essentialphoto.co.uk)

Made in China



### Before using this product:

Please read this user manual carefully in order to ensure your safety and the proper operation of this product. Keep for future reference.

## Foreword

### Thank you for purchasing this product.

This Li-ion580III M camera flash adopts PIXAPRO wireless ONE System and 2.4GHz radio transmission, which is compatible with HyBRID360 TTL, GIO1, ST-III, ST-III+, ST-IV etc. Fit all DSLR camera brands e.g. Canon, Nikon, Sony, etc.

This camera flash features:

- GN60 (m ISO 100, @200mm). Adjust from 1/1 to 1/128 in 1/3rd stops
- Professional 2600mAh lithium battery offers 450 flashes and 1.5s recycle
- Built-in 2.4GHz wireless transmission to support transmitting and receiving
- High speed sync, wireless remote control, multi flash and manual focus assist
- Stable consistency and color temperature with good even lighting
- User-friendly LCD display & control panel



## ⚠ Warning

- ⚠ Always keep this product dry. Do not use in rain or in damp conditions.
- ⚠ Do not disassemble. Should repairs become necessary, this product must be sent to an authorized maintenance center.
- ⚠ Keep out of reach of children.
- ⚠ Stop using this product if it breaks open due to extrusion, falling or strong hit. Otherwise, electric shock may occur if you touch the electronic parts inside it.
- ⚠ Do not fire the flash directly into the eyes (especially those of babies) within short distances. Otherwise visual impairment may occur.
- ⚠ Do not use the flash unit in the presence of flammable gases, chemicals and other similar materials. In certain circumstance, these materials may be sensitive to the strong light emitting from this flash unit and fire or electromagnetic interference may result.
- ⚠ Do not leave or store the flash unit if the ambient temperature reads over 50°C. Otherwise the electronic parts may be damaged.
- ⚠ Turn off the flash unit immediately in the event of malfunction.

# Contents

<b>01</b>	<b>Foreword</b>
<b>02</b>	<b>Warning</b>
<b>05</b>	<b>Name of Parts</b>
	Body
	Control Panel
	LCD Panel
	What's in the Box
	Separately Sold Accessories
<b>07</b>	<b>Battery</b>
<b>08</b>	<b>Attaching to a Camera</b>
<b>08</b>	<b>Using the Flash</b>
	Power Management
	Flash Output
	ZOOM: Setting the Flash Coverage
	M Mode: Manual Mode
	Multi Mode: Stroboscopic Flash
	S1 Mode
	S2 Mode
	 Hi-Speed Sync Triggering
	Custom Function----Focus Assist Beam
	Buzz Function
	Wireless Flash Shooting: Radio (2.4G) Transmission
	Sync Triggering
	Custom Function----Sleep Function
	C.Fn Setting Custom Functions
<b>15</b>	<b>Protection Function</b>
<b>16</b>	<b>Advanced Application</b>
<b>18</b>	<b>Technical Data</b>
<b>18</b>	<b>Maintenance</b>

## Conventions used in this Manual

- This manual is based on the assumption that both the camera and camera flash's power switches are powered on.
- Reference page numbers are indicated by "p.\*\*".
- The following alert symbols are used in this manual:
  -  The Caution symbol gives supplemental information.
  -  The Note symbol indicates a warning to prevent shooting problem.

## Name of Parts

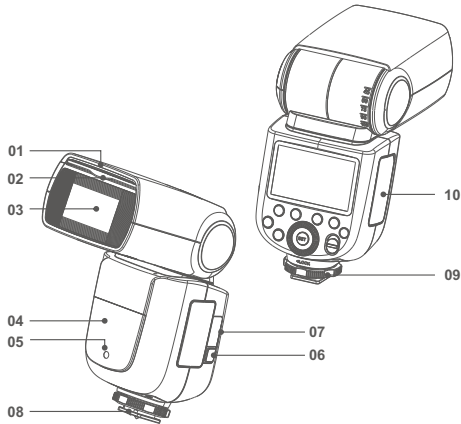

### • Body

- |                                     |                            |
|-------------------------------------|----------------------------|
| 01. Catchlight Panel                | 06. Battery Release Button |
| 02. Built-In Wide Panel (Retracted) | 07. Sync Cord Jack         |
| 03. Flash Head                      | 08. Hotshoe                |
| 04. Optic Control Sensor            | 09. Lock Ring              |
| 05. Focus Assist Beam               | 10. Battery Compartment    |

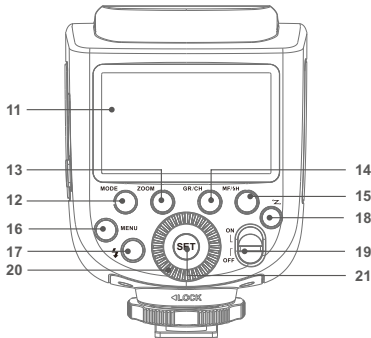

### • Control Panel

- |  |                                       |
|--|---------------------------------------|
| 11. Display  | 16. MENU Flash Menu                   |
| 12. MODE Flash Mode Selection                            | 17. Test Button/Flash Ready Indicator |
| 13. ZOOM Zoom Setting                                    | 18. 'Z' Wireless Setting Button       |
| 14. GR/CH Group/Channel Setting (long press)             | 19. ON/OFF Power Switch               |
| 15. MF/SH Focus Assist Beam/High-speed Sync (long press) | 20. Select Dial                       |
|  | 21. SET Set Button                    |

### • LCD Panel

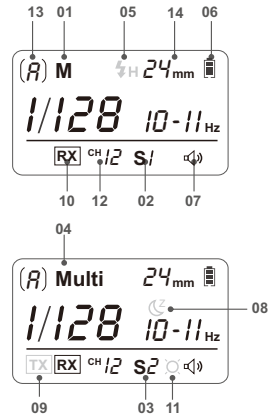

- |  |   |
|--|---|
| 19. <M> Manual Flash Mode                | 25. <[bell icon]> Sound Beep Indication |
| 20. <S1>S1 Slave Flash Triggering        | 26. <[sleep icon]> Sleep Status         |
| 21. <S2>S2 Slave Flash Triggering        | 27. TX Transmitter Mode                 |
| 22. <Multi>Multi/Stroboscopic Flash Mode | 28. RX Receiver Mode                    |
| 23. <[H]> High Speed Sync Triggering     | 29. <[Q]> Focus Assist Beam Indicator   |
| 24. <[B]> Battery Level Indication       | 30. Channel                             |
|  | 31. Group                               |
|  | 32. Zoom focal length                   |

### • What's in the Box

- Flash Unit
- Li-ion Battery Pack
- Battery Charger
- Battery Charger Cable
- Mini Stand
- Protection Case
- Instruction Manual

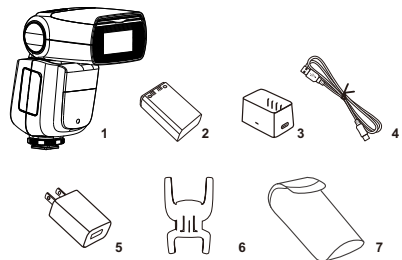

### • Separately Sold Accessories

The product can be used in combination with the following accessories sold separately, so as to achieve best photography effects: ST-III, ST-III+ and ST-IV TTL wireless flash trigger, Mini softbox, White & Silver Reflector, Honeycomb, Color gels, Snoot, etc.

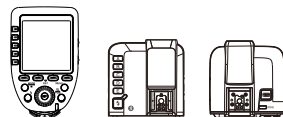

## Battery

### • Features

1. This flash unit uses Li-ion polymer battery which has long runtime. The available charge-and-discharge times are 500.
2. It is reliably safe. The inner circuit is against overcharge, overdischarge, overcurrent, and short circuit.
3. Take only 2.5 hours to fully charge the battery by using the standard battery charger.

### • Cautions

1. Do not short circuit.
2. Do not expose to rain or immerse into water. This battery is not water proof.
3. Keep out of reach of children.
4. No over 24 hours' continuous charging.
5. Store in dry, cool, ventilated places.
6. Do not put aside or into fire.
7. Dead batteries should be disposed according to local regulations.
8. If the battery had ceased using for over 3 months, please make a full recharge.
9. If do not use it for a long time, please charge the battery to approx. 60% before placing it.
10. It is recommended to use a brand-new battery after charging and discharging over 500 times or being used over 3 years.

### • Loading and Unloading the Battery

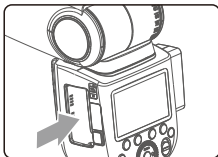

- 1 To unload the battery, hold down the battery remove button and push the battery downwardly to take it out.

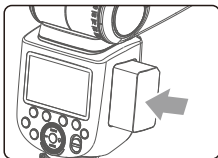

- 2 According to the triangle sign on the battery pack, insert it into the compartment until a white knob locks the battery with a click sound.

### • Battery Level Indication

Make sure the battery pack is securely loaded in the flash. Check the battery level indication on the LCD panel to see the remaining battery level.

Battery Level Indication	Meaning
3 grids	Full
2 grids	Middle
1 grid	Low
Blank grid	Lower battery, please recharge it.
Blinking	The battery level is going to be used out immediately. And the flash will auto power off in 1 minute. Note: Please recharge the battery as soon as possible (within 10 days). Then, the battery can be used or be placed for long period.

## Attaching to a Camera

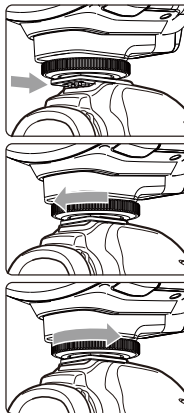

- 1 Attach the Camera Flash.
  - Rotate the hotshoe fixing buckle to the left and insert the camera flash into the camera's hotshoe.
- 2 Secure the Camera Flash.
  - Rotate the hotshoe fixing buckle to the right until it locks up.
- 3 Detach the Camera Flash.
  - Press the button and rotate the hotshoe fixing buckle to the left until it is loosened.

## Using the Flash

### 1. Power Management

Use ON/OFF Power Switch to power the flash unit on or off. Turn off if it will not be used for an extended period of time. This flash unit has Sleep Function and will enter into sleep status when there is no operation for a long time. For Sleep Function setting, see the following instruction.

### 2. Flash Output

- Flash output can be varied from 1/128th power to 1/1 full power in 1/3 stop increments. To obtain a correct flash exposure, use a hand-held flash meter to determine the required flash output.
- Adjust the power output by rotating Select Dial. The following table makes it easier to see how the stop changes in terms off/stop when you increase or decrease the flash output:

Figures displayed when reducing flash output level ➡

1/1	1/1-0.3	1/1-0.7	1/2	1/2-0.3	1/2-0.7	1/4	...	OF
	1/2+0.7	1/2+0.3		1/4+0.7	1/4+0.3		...	

← Figures displayed when increasing flash output level

- ▲ When "OF" is shown on the LCD display, it means no flash output and flash firing is turned off.

### 3. ZOOM: Setting the Flash Coverage

The flash coverage can be set to match the lens focal length from 20 mm to 200 mm. Press <ZOOM> button and rotate Select Dial <⊙> to change the flash coverage.

- ▲ When setting the flash coverage, make sure it covers the lens focal length so that the picture will not have a dark periphery.

## 4. M Mode: Manual Mode

Press MODE Selection Button <MODE> to enter M mode. In this mode, you can set the flash unit onto your camera hot shoe or your trigger hot shoe for firing. Before shooting, adjust the flash power output. When the camera's shutter is pressed, the flash will fire synchronously. Slave triggering mode is not available in M mode.

## 5. Multi Mode: Stroboscopic Flash

Press Mode Selection Button <MODE> to enter Multi mode (Stroboscopic flash). With stroboscopic flash, a rapid series of flashes is fired. It can be used to capture multiple images of a moving subject in a single photograph. You can set the firing frequency (number of flashes per sec. expressed as Hz), the number of flashes, and the flash output. For setting procedures, see the following:

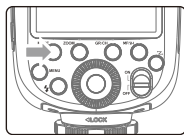

**1** Press the Mode Selection Button <MODE> so that "Multi" is displayed.



**2** Press Set Button <SET> to select the item to be set. The item blinks.

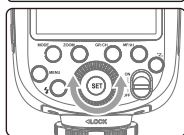

**3** Rotate Select Dial <⊙> to set a desired number.

### Calculating the Shutter Speed

During stroboscopic flash, the shutter remains open until the firing stops. Use the provided formula to calculate the shutter speed required to capture the full sequence of flashes:

$$\text{Number of flashes} / \text{Firing frequency} = \text{Shutter speed}$$

For example, if the number of flashes is 10 and the firing frequency is 5 Hz, the shutter speed should be at least 2 sec.

#### Note:

- Stroboscopic flash is most effective with a highly reflective subject against a dark background.
- Using a tripod and a remote switch is recommended.
- A flash output of 1/1 or 1/2 cannot be set for stroboscopic flash.
- Stroboscopic flash can be used with "buLb".

## Maximum Stroboscopic Flashes:

Flash output \ Hz	1	2	3	4	5	6-7	8-9
1/4	7	6	5	4	4	3	3
1/8	14	14	12	10	8	6	5
1/16	30	30	30	20	20	20	10
1/32	60	60	60	50	50	40	30
1/64	90	90	90	80	80	70	60
1/128	100	100	100	100	100	90	80

Flash output \ Hz	10	11	12-14	15-19	20-50	60-199
1/4	2	2	2	2	2	2
1/8	4	4	4	4	4	4
1/16	8	8	8	8	8	8
1/32	20	20	20	18	16	12
1/64	50	40	40	35	30	20
1/128	70	70	60	50	40	40

▲ To avoid overheating and deteriorating the flash head during stroboscopic flash, do not use stroboscopic flash more than 10 times in succession.

## 6. S1 Mode: S1 Slave Triggering Mode

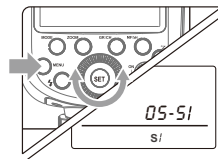

- Press the <MENU> button for 2 seconds to enter the custom menu and press <SET> Button to choose OS. Then, turn the Select Dial to choose OFF/S1/S2.
- In S1 mode, the flash unit can function as a slave flash for creating multiple lighting effects. It is respectively applicable to manual flash environment.
- In S1 mode, the flash unit will fire synchronously when the master flash fires, the same effect as

## 7. S2 Mode: S2 Slave Triggering Mode

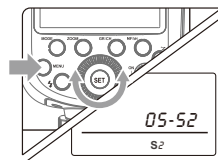

- Press the <MENU> button for 2 seconds to enter the custom menu and press <SET> Button to choose OS. Then, turn the Select Dial to choose OFF/S1/S2.
- In S2 mode, the flash unit can function as a slave flash for creating multiple lighting effects. It is applicable when using a TTL master flash.
- In S2 mode, the flash unit will ignore a single "preflash" from the master flash and will only fire in response to the second, actual flash from the master.

## 8. $\frac{1}{2}$ Hi-Speed Sync Triggering

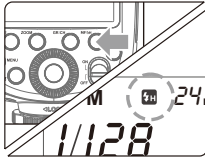

- To enter <math>\frac{1}{2}</math> mode, long press <MF/SH> button and hold for 2 seconds.
- To exit <math>\frac{1}{2}</math> mode, press Mode Selection Button or long press <MF/SH> button and hold for 2 seconds again.
- In <math>\frac{1}{2}</math> hi-speed sync triggering mode, you can use a hi-speed sync trigger to have your flash unit synchronized with all shutter speeds of cameras (max. 1/8000 second, up to your camera). This is convenient when you want to use aperture priority for fill-flash portraits.

**Note:** \*Hi-speed sync triggering mode is effective only when the flash unit is used together with the following flash triggers. (TTL wireless flash trigger ST-III, ST-III+, ST-IV)  
 \*Hi-speed sync triggering mode is not available when Li-ion580III M is mounted onto the camera.

▲ To avoid overheating or deteriorating the flash head during high speed sync flash, the over-temperature protection function will be activated automatically after 10 continuous high-speed flashes and the cycle time becomes 10 seconds longer.

## 9. Custom Function--Focus Assist Lamp

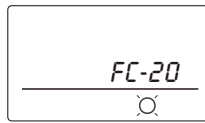
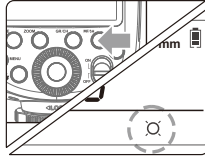

- Under poorly-lit or low-contrast conditions, you can press <MF/SH> button to turn on the focus assist beam in order to make it easier to autofocus.
- The beam will automatically put out certain seconds after the last pop is fired. The time between the last fire and the auto shutdown of focus assist beam is called No-Flash Time. The time is user adjustable and set to 10 seconds by default.
- Press <MENU> button to enter Custom Function. Then press "SET" button to enter "FC" mode. The LCD panel displays "FC" (Auto shutdown of focus assist lamp) and "No-Flash Time". Rotate Select Dial <> to set a desired time for the flash. Press <> button to return.

No-Flash Time	Meaning
10 seconds	10 seconds after the last fire, focus assist lamp will automatically get out.
20 seconds	20 seconds after the last fire, focus assist lamp will automatically get out.
30 seconds	30 seconds after the last fire, focus assist lamp will automatically get out.

## 10. Buzz Function

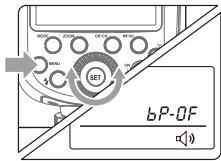

- To turn the buzz function on or off, press the <MENU> button to enter Custom Function.
- Then press "SET" button to enter "bp" mode. The LCD displays "ON" means buzz is turned on while "OF" means buzz is turned off.
- When the buzzer is turned on, <math>\langle \rangle</math> is shown on the LCD display.

## 11. Wireless Flash Shooting: Radio (2.4G)

### Transmission

- Li-ion580III M has 2.4GHz radio transmission (Master/Slave)
- **Wireless mode setting:** Press the <Z> wireless setting button to set TX or RX mode.
- **Channel setting:** Long press <GR/CH> button and hold for 2 seconds until the figure besides the CH is blinking. Turn the Select Dial to choose the channel from 1~32.
- **Group setting:** Short press <GR/CH> button to select group. In TX or RX mode, groups can be selected from A/B/C/D/E.
- **ID Setting:** Press the <MENU> button to enter the menu. Then, press SET button to choose ID and turn the select dial to select ID from OF, 01 to 99.
- As Li-ion580III M adopts PIXAPRO wireless ONE System, it is compatible

with ST-IV, ST-III+, ST-III, STORM II 600, Li-ion580II series, Li-ion580III series, GIO1 series, Li-ion350II, Hybrid360TTL, CITI1200Pro, CITI400Pro, CITI100Pro, PIKA200, CITI600Pro series, PIKA200Pro, CITI300Pro, etc.

• See the picture below:

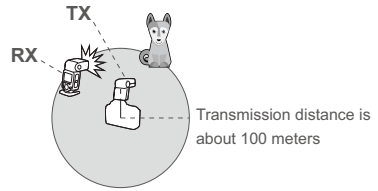

## 12. Sync Triggering

The Sync Cord Jack is a  $\Phi$ 2.5mm plug. Insert a trigger plug here and the flash will be fired synchronously with the camera shutter.



### 13. Custom Function - Sleep Function

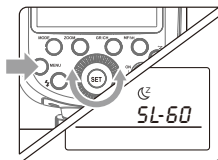

• This product is equipped with Sleep Function to avoid battery drain when the flash unit is idle.

• Press the <MENU> button to enter the sleep Function Mode. Press SET button to enter "SL" adjustment.

The LCD panel displays "SL" (Sleep) and "Sleeping Time". Idle time before entering Sleep Mode is 10 minutes by default. Rotate Select Dial <⊙> to set a desired time for the flash or to turn off Sleep Function.

Press <MENU> button to return.

Idle Time	Meaning
OF	Sleep Function is turned off. The flash unit will not automatically enter sleep mode.
3	Idle time before entering Sleep Mode is set to 3 minutes.
10	Idle time before entering Sleep Mode is set to 10 minutes.
30	Idle time before entering Sleep Mode is set to 30 minutes.
60	Idle time before entering Sleep Mode is set to 60 minutes.

- When the flash enters sleep mode, the LCD panel displays a "Ⓜ" icon.
- To wake up the flash unit, press any button on the flash unit, or press the camera release button, or press the trigger TEST button.

#### Note:

The idle time before entering Sleep Mode is recommended to set short. This can ensure a longer battery life.

### 14. Custom Function - Sleep Function

Custom Function Signs	Function	Settings & Description	Operation
SL	Sleeping Time Setting	Settable Time: <3> 3 minutes <10> 10 minutes <30> 30 minutes <60> 60 minutes <OF> OFF	1. Press <MENU> button to enter Custom Functions. 2. Turn the Select Dial <⊙> to adjust sleeping time. 3. Press <MENU> button to return. * Press any button can wake up the flash. * The idle time before entering Sleep Mode is recommended to set short. This can ensure a longer battery life.
FC	Auto Power OFF Time Setting of Auto Focus Assist	<10> 10 seconds <20> 20 seconds <30> 30 seconds	1. Press <MENU> button to enter Custom Functions. 2. Press <SET> button to enter FC states. 3. Turn the Select Dial <⊙> to adjust. 4. Press <MENU> button to return.
BP	Buzz Setting	<ON> On <OF> Off	1. Press <MENU> button to enter Custom Functions. 2. Press <SET> button to enter bp states. 3. Turn the Select Dial <⊙> to adjust. 4. Press <MENU> button to return.
BL	Backlight Setting	Backlight can be set as follows: <ON>: Always lighting <12>: Off in 12 sec <OF>: Off	1. Press <MENU> button to enter Custom Functions. 2. Press <SET> button to enter bL states. 3. Turn the Select Dial <⊙> to adjust. 4. Press <MENU> button to return.
OS	Optic Slave Mode	<OF> Off <S1> S1 mode <S2> S2 mode	1. Press <MENU> button to enter Custom Functions. 2. Press <SET> button to enter OS states. 3. Turn the Select Dial <⊙> to adjust. 4. Press <MENU> button to return.
ID	ID Setting	<OF> Off <01-99> 01-99	1. Press <MENU> button to enter Custom Functions. 2. Press <SET> button to enter id states. 3. Turn the Select Dial <⊙> to adjust. 4. Press <MENU> button to return.

- Display all functions: press and hold down MENU and MODE button, then, turn the flash on to check the display.
- Software version checking: press and hold down SET button, then, turn the flash on to check the number of version.

## Protection Function

### 1. Over-Temperature Protection

- To avoid overheating and deteriorating the flash head, do not fire more than 30 continuous flashes in fast succession at 1/1 full power. After 30 continuous flashes, allow a rest time of at least 10 minutes.
- If you fire more than 30 continuous flashes and then fire more flashes in short intervals, the inner over-temperature protection function may be activated and make the recycling time over 10 seconds. If this occurs, allow a rest time of about 10 minutes, and the flash unit will then return to normal.
- When the over-temperature protection is started,  is shown on the LCD display.

**Number of flashes that will activate over-temperature protection:**

Number of Flashes / Power Output Level \ ZOOM (mm)	20 - 200
1/1	35
1/2	50
1/4	100
1/8	200
1/16	300
1/32	500
1/64	1000
1/128	2000

**Number of flashes that will activate over-temperature protection in high-speed sync triggering mode:**

Number of Flashes / Power Output Level \ ZOOM (mm)	20 - 200
1/1	30
1/2	30
1/4	34
1/8	40
1/16	50
1/32	50
1/64	60
1/128	60

### 2. Other Protections

The system provides real-time protection to secure the device and your safety. The following lists prompts for your reference:

Prompts on LCD Panel	Meaning
E1	A failure occurs on the recycling system so that the flash cannot fire. Please restart the flash unit. If the problem still exists, please send this product to a maintenance center.
E2	The system gets excessive heat. Please allow a rest time of 10 minutes.
E3	The voltage on two outlets of the flash tube is too high. Please send this product to a maintenance center.
E9	There are some errors occurred during the upgrading process. Please using the correct firmware upgrade method.

## Advanced Application

### • Bounce Flash

By pointing the flash head toward a wall or ceiling, the flash will bounce off the surface before illuminating the subject. This can soften shadows behind the subject for a more natural-looking shot. This is called bounce flash. To set the bounce direction, hold the flash head and turn it to a satisfying angle.

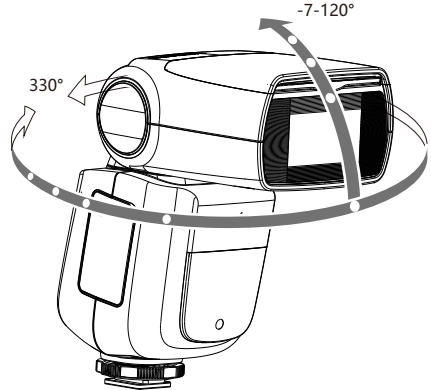

- If the wall or ceiling is too far away, the bounced flash might be too weak and result in underexposure.
- The wall or ceiling should be a plain, white color for high reflectance. If the bounce surface is not white, a color cast may appear in the picture.

### • Creating a Catchlight

With the catchlight panel, you can create a catchlight in the subject's eyes to add life to the facial expression.

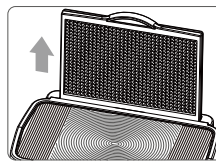

- 1 Point the flash head upward by 90°.

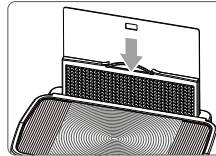

- 2 Pull out the wide panel. The catchlight panel will come out at the same time.

- 3 Push the wide panel back in.
  - Push in only the wide panel.
  - Follow the same procedures as for bounce flash.

- Point the flash head straight ahead and then upward by 90°. The catchlight will not appear if you swing the flash head left or right.
- For best catchlight effect, stay 1.5m/4.9ft away from the subject.

## • Using the Wide Panel

Pull out the built-in wide panel to enlarge the flash lighting range, so as to get more softened and natural lighting effect.

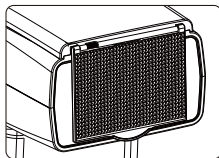

Pull out the wide panel and place it over the flash head as shown. The flash coverage will then be extended to 14 mm.

- The catchlight panel will come out at the same time. Push the catchlight panel back in.

### Reasons & Solutions for Flash Not Triggering

#### 1. Disturbed by the 2.4GHz signal in outer environment (e.g. wireless base station, 2.4GHz wifi router, Bluetooth, etc.)

→ To adjust the channel CH setting on the flash trigger (add 10 channels) and use the channel which is not disturbed. Or turn off the other 2.4GHz equipment in working.

#### 2. Please make sure that whether the flash has finished its recycle or caught up with the continuous shooting speed or not (the flash ready indicator is lighten) and the flash is not under the state of over-heat protection or other abnormal situation.

→ Please downgrade the flash power output.

#### 3. Whether the distance between the flash trigger and the flash is too close or not

→ Please turn on the "close distance wireless mode" on the flash trigger (< 0.5m):

ST-III+ & ST-III series: press the test button and hold on, then turning it on until the flash ready indicator blinks for 2 times.

ST-IV series: Set the C.Fn-DIST to 0-30m.

#### 4. Whether the flash trigger and the receiver end equipment are in the low battery states or not

→ Please replace the battery (the flash trigger is recommended to use 1.5V disposable alkaline battery).

## Technical Data

Model	Li-ion580III M
Power (1/1 output)	76Ws
Guide No.(1/1 output, 200mm)	GN≈60 (m ISO100)
Flash Coverage	20 to 200mm • Manual zoom • Swinging/tilting flash head (bounce flash): 0 to 330° horizontally and -7° to 120° vertically
Flash Duration	1/300 to 1/20000 seconds
• Wireless Flash	
Wireless flash function	Transmitter, Receiver, Off
Transmitter groups	A, B, C, D
Controllable Receiver groups	A, B, C, D, E (E group can be controlled by ONE System flash triggers)
Transmission range (approx.)	100m
Channels	32 (1-32)
ID	01-99
• Power Supply	
Power source	7.2V/2600mAh Li-ion battery
Recycle time	Approx 1.5 seconds. Green LED indicator will light up when the flash is ready.
Full power flashes	Approx. 450
Power saving	Power off automatically after approx. 3, 10, 30 or 60 minutes of idle operation.
• Sync Triggering Mode	
	Hotshoe, 2.5mm sync line
• Dimensions	
W x H x D	199x71.5x60 mm
Weight without battery	390g
Weight with battery	500g
2.4GHz Frequency Range	2413.0MHz-2465.0 MHz
Max. Transmitting Power	5dbm

## Maintenance

- Shut down the device immediately should abnormal operation be detected.
- Avoid sudden impacts and the product should be dedusted regularly.
- It is normal for the flash tube to be warm when in use. Avoid continuous flashes if unnecessary.
- Maintenance of the flash must be performed by our authorized maintenance department which can provide original accessories.
- This product, except consumables e.g. flash tube, is supported with a one-year warranty.
- Unauthorized service will void the warranty.
- If the product had failures or was wetted, do not use it until it is repaired by professionals.
- Changes made to the specifications or designs may not be reflected in this manual.

## FCC Statement

This device complies with part 15 of the FCC Rules. Operation is subject to the following two conditions: (1) This device may not cause harmful interference, and (2) this device must accept any interference received, including interference that may cause undesired operation.

Any Changes or modifications not expressly approved by the party responsible for compliance could void the user's authority to operate the equipment.

Note: This equipment has been tested and found to comply with the limits for a Class B digital device, pursuant to part 15 of the FCC Rules. These limits are designed to provide reasonable protection against harmful interference in a residential installation. This equipment generates uses and can radiate radio frequency energy and, if not installed and used in accordance with the instructions, may cause harmful interference to radio communications. However, there is no guarantee that interference will not occur in a particular installation. If this equipment does cause harmful interference to radio or television reception, which can be determined by turning the equipment off and on, the user is encouraged to try to correct the interference by one or more of the following measures:

- Reorient or relocate the receiving antenna.
- Increase the separation between the equipment and receiver.
- Connect the equipment into an outlet on a circuit different from that to which the receiver is connected.
- Consult the dealer or an experienced radio/TV technician for help.

The device has been evaluated to meet general RF exposure requirement.

The device can be used in portable exposure condition without restriction.