

705-MF1200-00

PIXAPRO®

# MACRO MF12

Macro Flash

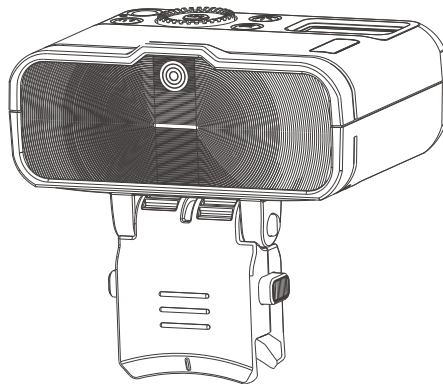

**PIXAPRO Ltd.**

UNIT 5 Sterling Park, Pedmore Road, Brierley Hill, Wes Midlands, DY5 1TB

el: +44 (0)121 552 113 E-mail: [info@essentialphoto.co.uk](mailto:info@essentialphoto.co.uk)

[www.essentialphoto.co.uk](http://www.essentialphoto.co.uk)

Made in China



Instruction Manual

# Contents

02	<b>Forward</b>
03	<b>Warning</b>
05	<b>Names of Parts</b>
	Body
	Control Panel
	OLED Display
06	<b>Included Items</b>
06	<b>Optional Accessories</b>
07	<b>Battery</b>
09	<b>Battery Management</b>
10	<b>Modeling Lamp</b>
10	<b>Flash Mode Selection</b>
	TTL Auto Flash Mode
	M Manual Flash Mode
12	<b>Wireless(2.4G) Transmission</b>
14	<b>C.Fn: Setting Custom Functions</b>
14	<b>Reset Function</b>
14	<b>Forced Shutdown Function</b>
14	<b>Over-Temperature Function</b>
15	<b>Technical Data</b>
16	<b>Maintenance</b>

# Foreword

Thank you for purchasing!

The MACRO MF12 is a mini macro flash.

Functionally, MACRO MF12 is equipped with two flash modes: TTL automatic flash mode and M manual flash mode. With S1 / S2 secondary optic triggering mode, no additional command signal or external remote control, direct trigger flash, convenient. Allocated with always-on LED modeling light, it provides modeling light anywhere anytime, which can also be used as a background light, hair light, or daily lighting.

In terms of structure, MACRO MF12 adopts professional optical lens design, which has stronger focusing effect and ensures even distribution of shooting light effect. Built-in rechargeable lithium battery, it is convenient for outdoor shooting and travel shooting. Menu easy to operate, compact and light-weight size ensure it can be put into pocket with great portability.

This mini flash is ideal for macro photography of animals and plants, food, jewelry, oral images and so on.

## Main Features

- Equipped with TTL automatic flash mode and M manual flash mode
- Having S1 / S2 secondary optic triggering modes
- Using a constant light LED modeling Light
- Adopted professional optical lens which offers more even lights
- Built-in 2.4GHz Wireless ONE System
- Selecting the clear OLED display
- With built-in lithium battery which can be charged through Type-C port
- Max.1.7s recycle and 500 full power pops

## ⚠ Warning

- ⚠ Always keep this product dry.
- ⚠ Do not disassemble. Should repairs become necessary, this product must be sent to an authorized maintenance center.
- ⚠ Keep out of reach of children.
- ⚠ Stop using this product if it breaks open due to extrusion, falling or strong hit. Otherwise, electric shock may occur if you touch the electronic parts inside it.
- ⚠ Do not fire the flash directly into the eyes (especially those of babies) within short distances. Otherwise visual impairment may occur.
- ⚠ Do not use the flash unit in the presence of flammable gases, chemicals and other similar materials. In certain circumstance, these materials may be sensitive to the strong light emitting from this flash unit and fire or electromagnetic interference may result.
- ⚠ Do not leave or store the flash unit if the ambient temperature reads over 50. Otherwise the electronic parts may be damaged.
- ⚠ As this product do not have waterproof function, please take measures of waterproof in rainy or damp environment.
- ⚠ Turn off the flash unit immediately in the event of malfunction.

## Names of Parts

### • Body

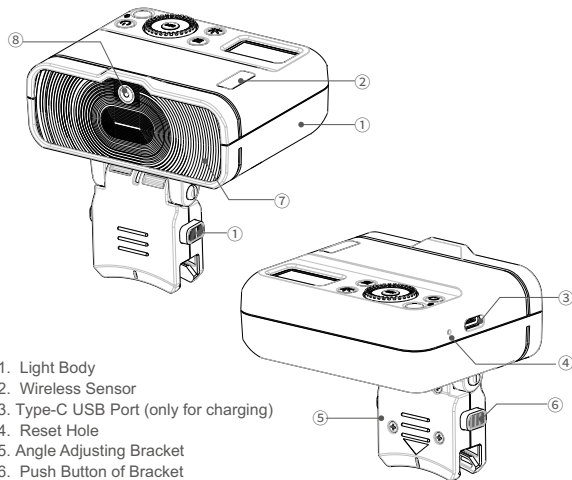

1. Light Body
2. Wireless Sensor
3. Type-C USB Port (only for charging)
4. Reset Hole
5. Angle Adjusting Bracket
6. Push Button of Bracket
7. Lens
8. Modeling Lamp

## Names of Parts

### • Control Panel

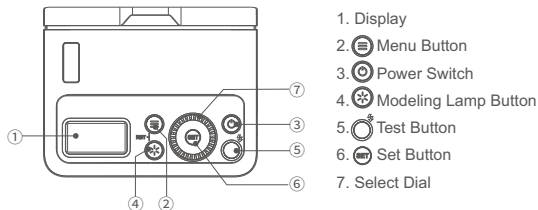

### • OLED Display

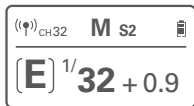
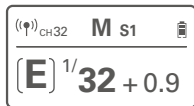
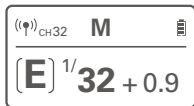

## Included Item

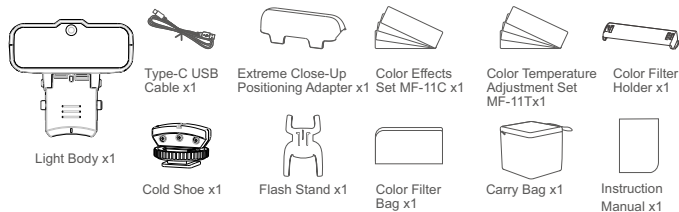

**Note:** MACRO MF12 Two-light Kit is not only including above items but also including 1 unit MF-AR Adapter Ring and 8 pieces lens adaptor rings (Diameters of 49mm,52mm,55mm,58mm, 62mm,67mm,72mm,77mm).

## Optional Accessories

The product can be used in combination with the following optional accessories, so as to achieve best photography effects: ST-IV, ST-III and ST-III+ TTL flash trigger, MF-AR adapter ring, camera lens adapter rings kit (49mm, 52mm, 55mm, 58mm, 62mm, 67mm, 72mm, 77mm), etc.



## Install Accessories

### • How to Install Cold Shoe

1. Press and hold down the push button of MACRO MF12's fixing bracket. Then, aim one end of the cold shoe into the end of bracket and slide it to install until a "click" can be heard.
2. Attach the cold shoe onto the hotshoe of camera firstly. Then, turn the locking ring and lock them.

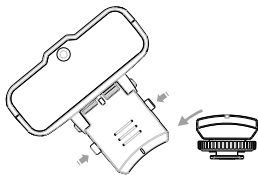

### • How to Use Adapter Ring (Optional)

1. Aim the socket of MACRO MF12 into the sliding block and push it until a "click" can be heard. One adapter ring can install 6 lights at most.

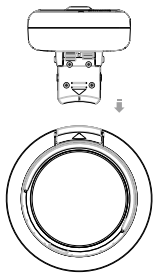

2. MACRO MF12 can be rotated leftwards or rightward by pressing the push button of bracket.

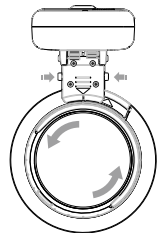

3. Choose the optional adapter ring (8 different diameters of 49mm, 52mm, 55mm, 58mm, 62mm, 67mm, 72mm, 77mm, etc.) whose size is suitable for the neck strap of camera lens. Install the camera's adapter ring onto the MF-AR adapter ring.

4. Attach the adapter ring onto the camera lens.

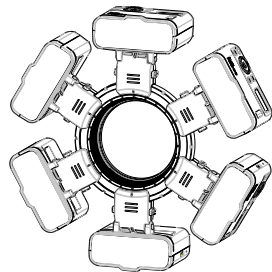

## Battery

1. This adopts Li-ion battery which is non-detachable.
2. It is reliably safe. The inner circuit is against overcharge, overdischarge, overcurrent, and short circuit.
3. Take only approx. 55 minutes (within 1 hour) to fully charge the battery by using the 5V/2A charger.

### • Battery Level Indicator

Battery Level Indication	Meaning
3 grids	Full
2 grids	Middle
1 grid	Low
Blank grid	Low battery, please recharge it.
 is displayed	The battery level is going to be used out immediately. And the flash will auto power off in 10 seconds. Note: please recharge the battery as soon as possible (within 10 days). Then, the battery can be used or be placed for long period.

## Power Management

Please turn off the power if not used for a long time.

### Auto Power off Mode Setting

Press the menu button, turn the Dial to select STBY, press the SET button, and then turn the Dial to select 30min/60min/90min/OFF.

After setting the auto power off mode, the flash will automatically shut down when unattended operation for a long time (more than 30/60/90 minutes). When it is automatically shut down, please press the power on button to restart it, the boot animation appears, turn the Dial to operate.



When using off the camera, it is recommended to turn off the "auto power off" mode through C.Fn-STBY of custom setting functions.

## Modeling Lamp

### 1. Modeling lamp power ON/OFF:

1.1. Short press the  button to control the on/off of LED modeling lamp.

1.2. Long press the  button to enter the modeling lamp interface and then short press SET button to on/off modeling lamp.

2. **Modeling lamp setting:** long press the  button to enter modeling lamp interface.

2.1 Brightness setting: turn the select dial to setting the brightness value from 1 to 10 levels.

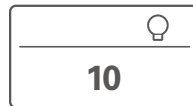

## Flash Mode Selection

MACRO MF12 flash has two modes: TTL autoflash and M manual flash. In TTL mode, the camera and the flash will work together to calculate the correct exposure for the subject and the background.

The main subject is correctly exposed regardless of background brightness. This is useful when you want to highlight the main subject or make exposure compensation.

In Manual flash photography, you select the aperture and flash output level. In this way, you can control the exposure and flash shooting distance when shooting subjects where the correct exposure is difficult to obtain in the TTL auto flash mode.

Short press the  menu button and turn the select dial to choose MODE. Then, short press the SET button and turn the select dial to choose TTL or M mode. Then, short press the SET button to exit from Mode Selection.

### • TTL Autoflash Mode

Choose TTL mode and press the  menu button to back to the interface and the flash will enter TTL autoflash mode.

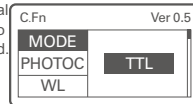

## • M Manual Flash Mode

The flash output is adjustable from 1/128 to 1/1 full power in 0.1 and 1 step increment.

1. Choose M and press the  menu button to back to the main interface.
2. In M mode's main interface, turn the select dial to set the flash output value.

To obtain a correct flash exposure, use a hand-held flash meter to determine the required flash output.

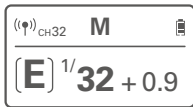

## • Light Control Flash (PHOTOC)

In M manual mode, press the  menu button to enter C.Fn and turn the select dial to choose PHOTOC. Then, press the SET button and turn the select dial to choose S1 or S2 function.

### • S1 Secondary Optic Triggering

Choose S1 light control synchronous flash, flash MACRO MF12 can be used as auxiliary Light, create a variety of lighting effects, suitable for manual flash environment. It will trigger the flash synchronously with the first flash of the main flash. The effect is the same as using the wireless flash guide, and the response is sensitive.

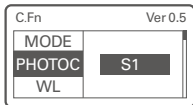

### • S2 Secondary Optic Triggering with Anti-preflash

Select S2 light control to prevent pre flash, flash MACRO MF12 can be used as auxiliary light, suitable for TTL automatic flash shooting environment. With high-energy anti pre flash function, when using the camera with a pre flash function, S2 light control pre flash function is used to achieve synchronous shooting. At the same time, it will trigger the flash synchronously with the second flash of the main flash with TTL function, that is, the second light control flash.

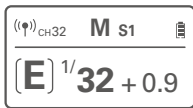

 MF12 flash only supports S1/S2 light control flash in M manual flash mode.

## Wireless Radio Transmission

With built-in PIXAPRO 2.4GHz Wireless ONE System, this MACRO MF12 can be used in combination with PIXAPRO ST-III, ST-IV and ST-III+ trigger. As a auxiliary unit, MACRO MF12 can be compatible with Canon, Nikon, Sony, Panasonic, Olympus/Fuji system and switched automatically. Nikon camera (using ST-III-T-N), Canon camera (using ST-III-T-C) and Sony camera (using ST-III-T-S) can share one or more MACRO MF12's TTL functions.

## • Wireless (WL) Setting

Press the  menu button to enter C.Fn custom setting. Turn the select dial to choose wireless WL, press the SET button, and turn the select dial to choose ON or OFF. OFF means the wireless function is turned off while ON means turned on.

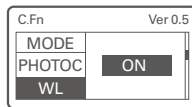

## • Channel (CH) Setting

If there are other wireless flash systems nearby, you can change the channels to prevent signal interference. The channel (CH) of the transmitter unit and the receiver unit(s) must be set to the same. Press the  menu button to enter C.Fn menu. Turn the select dial to choose CH. Press the SET button and turn the select dial to choose channel from 01- 32. Then, short press the SET button to exit from CH setting.

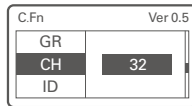

## • Group (GR) Setting

Enter C.Fn menu and turn the select dial to choose GR. Press the SET button and turn the select dial to choose group from A/B/C/D/E. Then, short press the SET button to exit from GR setting.

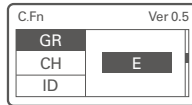

## • ID Setting

Enter C.Fn menu and turn the select dial to choose ID. Press the SET button and turn the select dial to choose ID from OFF and 01 to 99. Then, short press the SET button to exit from ID setting.

Note: this can only be used when the main unit has this function.

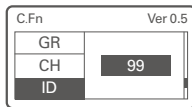

## ⚠ The Reason & Solution of Not Triggering in PIXAPRO 2.4GHz Wireless

### 1. Disturbed by the 2.4GHz signal in outer environment (e.g. wireless base station, 2.4GHz wifi router, Bluetooth, etc.)

→ To adjust the channel CH setting on the flash trigger (add 10+ channels) and use the channel which is not disturbed. Or turn off the other 2.4GHz equipment in working.

### 2. Please make sure that whether the flash has finished its recycle or caught up with the continuous shooting speed or not (the flash ready indicator is lightened) and the flash is not under the state of over-heat protection or other abnormal situation.

→ Please downgrade the flash power output. If the flash is in TTL mode, please try to change it to M mode (a preflash is needed in TTL mode).

### 3. Whether the distance between the flash trigger and the flash is too close or not

Please turn on the "close distance wireless mode" on the flash trigger (<0.5m):



ST-III series: Press and hold the flash button, then turn on the machine until the indicator light flashes twice.

ST-III+, ST-IV series: Set C.Fn-DIST to 0-30m.

### 4. Whether the flash trigger and the receiver end equipment are in the low battery states or not

→ Please replace the battery (the flash trigger is recommended to use 1.5V disposable alkaline battery).

## C.Fn: Setting Custom Functions

1. Press the  button to enter C.Fn and turn the select dial to choose the custom setting functions.
2. Press the SET button and turn the select dial to set the parameters.
3. After finishing all the settings, press the SET button to confirm and press the  button to exit.

Custom Function Signs	Functions	Settings	Settings & Descriptions
MODE	Flash mode	M	Manual flash
		TTL	Auto flash
PHOTOC	S1/S2 Light controlled flash	OFF	Off
		S1	S1 Secondary Optic Triggering
		S2	S2 Secondary Optic Triggering with Anti-preflash
WL	Wireless setting	ON	Wireless on
		OFF	Wireless off
GR	Group setting	A/B/C/D/E	Choose any letters from A/B/C/D/E
CH	Channel setting	1~32	Choose any figure from 1 to 32
ID	ID setting	OFF/01~99	Choose any figure from 01 to 99 or OFF
STBY	Auto power off	OFF	Off
		30min	The flash will automatically shut down when unattended operation for a long time (more than 30/60/90 minutes).
		60min	
		90min	

## Forced Shutdown Function

When the light's system crashes or cannot be operated, insert a needle into the reset hole to forced shutdown the device.

## Over-Temperature Protection

When the continuous flashes fires up to 50 times in fast succession at 1/1 full power, an Over-Temperature Protection symbol appears on the display to remind the user that the flash unit is overheated. It is recommended to temporarily stop the macro flash.

## Reset Function

Long press  menu button and  modeling lamp button at the same time to realize the function of settings reset function.



## Technical Data

<b>Model</b>	MACRO MF12
Built-in Lithium Battery	3.7V/6.29W
Guide No. (1/1 output)	GN=16.1 (±0.1)
Flash Power	12W
Output Level	8 levels: 1/128~1/1
Brightness of LED Modeling Lamp	1~10 Levels
Display	OLED Display
Optical Flash	S1 Secondary Optic Triggering S2 Secondary Optic Triggering with Anti-preflash
Flash Mode	TTL Autoflash, M manual flash
Flash Duration	1/1200s~1/34000s
2.4GHz Wireless Transmission	ON/OFF
Channel	32 channel: 1~32
Group	5 group: A/B/C/D/E
ID	OFF/01~99
Transmission Distance	30m
Type-C Power Charging	5V 2A
Full Power Flashes	Approx. 500
Recycle Time	Approx. 0.01~1.7s
Battery Level Indication	Battery level indicator shows on the upper right corner of the display
Power Saving	30min/60min/90min: It will automatically power off when unattended operation over 30min/60min/90minutes. OFF: Turn off auto power off mode,energy-saving performance is invalid.
<b>Dimension</b>	
Size	81*76.5*64.3mm
Net Weight	≈144g

## Maintenance

- Shut down the device immediately should abnormal operation be detected.
- Avoid sudden impacts and the product should be dedusted regularly.
- It is normal for the light beads to be warm when in use. Avoid continuous flashes if unnecessary.
- Maintenance of the light must be performed by our authorized maintenance department which can provide original accessories.
- This product, except consumables, is supported with a one-year warranty. Lithium battery is supported with six months warranty.
- Unauthorized service will void the warranty.
- If the product had failures or was wetted, do not use it until it is repaired by professionals.
- Changes made to the specifications or designs may not be reflected in this manual.

## FCC Statement

This device complies with part 15 of the FCC Rules. Operation is subject to the following two conditions: (1) This device may not cause harmful interference, and (2) this device must accept any interference received, including interference that may cause undesired operation.

Note: This equipment has been tested and found to comply with the limits for a Class B digital device, pursuant to part 15 of the FCC Rules. These limits are designed to provide reasonable protection against harmful interference in a residential installation. This equipment generates uses and can radiate radio frequency energy and, if not installed and used in accordance with the instructions, may cause harmful interference to radio communications. However, there is no guarantee that interference will not occur in a particular installation. If this equipment does cause harmful interference to radio or television reception, which can be determined by turning the equipment off and on, the user is encouraged to try to correct the interference by one or more of the following measures:

- Reorient or relocate the receiving antenna.
- Increase the separation between the equipment and receiver.
- Connect the equipment into an outlet on a circuit different from that to which the receiver is connected.
- Consult the dealer or an experienced radio/TV technician for help.