



**7 Inch 4K Touch Screen High Brightness Monitor With HDR**

**Monitor Usage Guide**













# Contents

- PACKING LIST
- NOTICE
- QUICK START
- MENU OPERATION GUIDE
- IMPORT LUTs
- UPGRADE INSTRUCTION
- MENU GUIDE
- SPECIFICATIONS
- WARRANTY

## PACKING LIST

Before using this product, please check carefully whether everything is in the package.  
If there is anything missing, please contact us

 <p>Monitor</p>	 <p>Hotshoe</p>	 <p>U Disk</p>	 <p>HDMI Micro</p>	 <p>Sun Hood</p>
 <p>HDMI Mini</p>	 <p>D-Tap</p>	 <p>Storage Bag</p>	 <p>Microfiber Cloth</p>	 <p>Instruction Manual</p>

## NOTICE

Thank you for buying the monitor. The content mentioned in this article concerns your safety and legitimate rights and responsibilities. Please read this article carefully before using this product, to ensure that the product has been properly set up. Failure to follow the instructions and warnings in this article may cause harm to you and the people around you, and damage the monitor or other surrounding items. The final interpretation rights of this document and all relevant documents of the monitor belong to Shenzhen Bestview Electronics Co., Ltd. as It is updated without notice. Please visit official website: [www.desview.com](http://www.desview.com) to get the latest product information.

By using this product, you are deemed to have read the disclaimer and warning carefully. Understand, acknowledge and accept all the terms and contents of this statement You promise to. Take full responsibility for using this product and possible consequences. You undertake to use this product only for legitimate purposes, and agree to this clause and any relevant regulations, policies and guidelines established by Desview.

Desview is not responsible for any loss injury or any liability arising from direct or indirect use of the product. Users should follow all security guidelines including but not limited to this article.

## Body Size

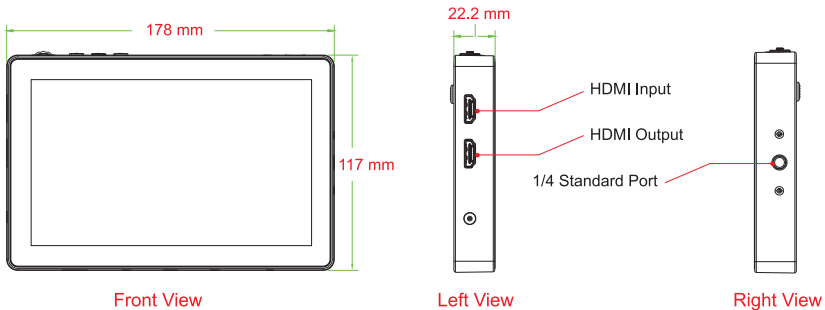

# QUICK START

Battery Slot

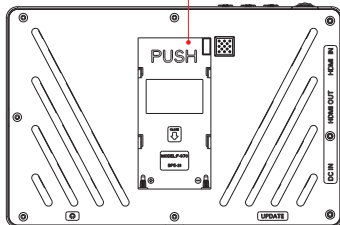

Rear View

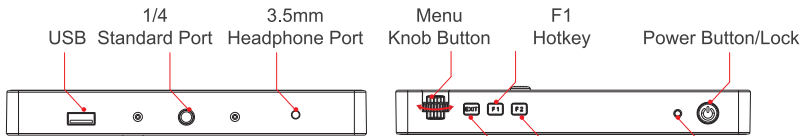

Top View

Exit F2 Hotkey

LED light

# MENU OPERATION GUIDE

**Attention:** This is a capacitive touch screen monitor, all option and content in menu can be operated by touch screen or use the knob button.



Double-tap screen to open the menu



Touch on the screen beside menu to exit menu interface



Pinch to Zoom



# IMPORT LUTs

1. Copy the Log file into the U disk.
2. Insert the U disk into the monitor's USB interface.

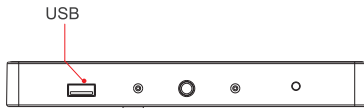

3. Find the 'Custom Lut\_usb" in the LUT config menu, then touch "Search USB".



4. Open the LUT file you find.

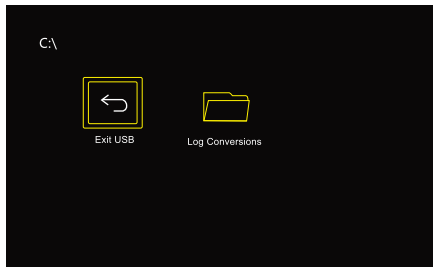

## QUICK STARTING

5. Choose the LUT you need to use, when the icon shows  , it indicates that the LUT has been imported successfully.

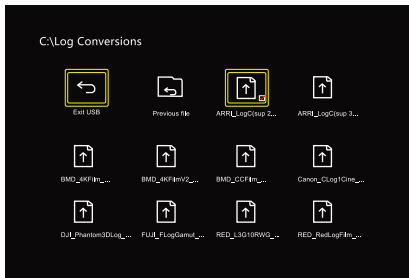

6. After import the LUT file, touch "Exit USB", then pull out the U disk.

## UPGRADE INSTRUCTION

1. Copy the downloaded upgrade program into the U disk.
2. Insert the U disk into the monitor's USB interface.



3. Find the "Update" in "System config" menu, then touch "OK"

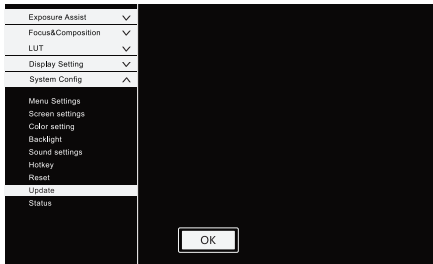

The LED light which nears the power button will start flashing with red and green color.

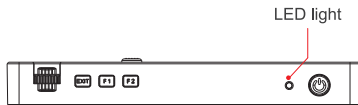

4. The monitor will turn on automatic when the update is finished.

# MENU GUIDE

Exposure Assist 

False color



Zebra



Histogram



Waveform



Vectorscope

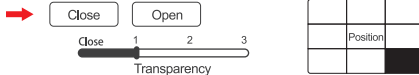

All Wave

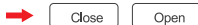

HDR



# MENU GUIDE

Focus&Composition ^

Single Color



Peaking

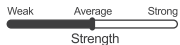

Center Mark



Safe Area

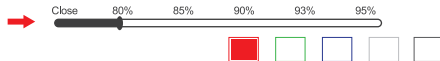

Mark Ratio

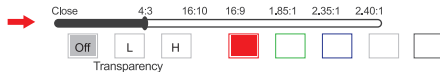

Grid Lines



Audio Meters



# MENU GUIDE

LUT Config ^

LUT



Custom LUT\_ usb

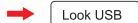

Display Setting ^

Aspect Ratio



Display Flip



Zoom

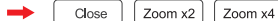

Pixel-to-Pixel

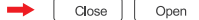

HV Delay



Frame



Battery notification

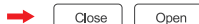

Anamorphic

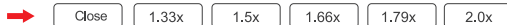

# MENU GUIDE

System Config 

Menu Config

Color

Color Temperature

Backlight

Sound

Hotkey



Reset



Update

Status

Language

→ Duration

→ Brightness  Contrast 

Sharpness  Saturation 

→ Color Temperature

Red 

Green 

Blue 

→ Backlight    

→   Volume 

→

<input type="button" value="Luminance Waveform"/>	<input type="button" value="RGB Waveform"/>	<input type="button" value="Brightness Histogram"/>	<input type="button" value="RGB Histogram"/>
<input type="button" value="Vectorscope"/>	<input type="button" value="False color"/>	<input type="button" value="Zebra"/>	<input type="button" value="Single Color"/>
<input type="button" value="Peaking"/>	<input type="button" value="Center Mark"/>	<input type="button" value="SafeArea"/>	<input type="button" value="Mark Ratio"/>
<input type="button" value="Grid Lines"/>	<input type="button" value="Audio Meters"/>	<input type="button" value="LUT"/>	<input type="button" value="Look USB"/>
<input type="button" value="Aspect Ratio"/>	<input type="button" value="H Flip"/>	<input type="button" value="V Flip"/>	<input type="button" value="Pixel-to-Pixel"/>

→ Input	HDMI	Resolution	NO signal	Scan Mode	NO signal
Frame	NO signal	Color Temperature	6500K	Aspect Ratio	Auto
Backlight	80	Volume	50	R7PV3.3	20200110

## SPECIFICATIONS

Screen Size	7 inch
Machine Size	178x117x22.2mm
Weight	380g
Resolution	1920x1200
Contrast	1100:1
Brightness	1000
Viewing Angle	178°(H/V)
Backlight	LED
Material	ABS engineering plastic
Voltage	DC7-24V
Power	12W
Signal Input	HDMI1.4
Signal Output	HDMI1.4
Audio Output	3.5mm stereo headphone jack



## SPECIFICATIONS

### HDMI input signal format

720x480i&720x480p@59.94, 60Hz

720x576i&720x576p@50Hz

1280x720p@50, 59.94, 60Hz

1920x1080i@50, 59.94, 60Hz

1920x1080psf@24, 25, 29.97, 30Hz

1920x1080p@23.93, 24, 25, 29.97,30,

50,59.94,60Hz

3840x2160p@24,25,30Hz

4096x2160p@24Hz

### HDMI output signal format

720x480i&720x480p@59.94, 60Hz

720x576i&720x576p@50Hz

1280x720p@50, 59.94, 60Hz

1920x1080i@50, 59.94, 60Hz

1920x1080psf@24, 25, 29.97, 30Hz

1920x1080p@23.93, 24, 25, 29.97,30,

50,59.94,60Hz

3840x2160p@24,25,30Hz

4096x2160p@24Hz

## WARRANTY INTRODUCTION

**Thank you for buying the product .You can enjoy the following services:**

- 1.The product will enjoy one year free warranty and free maintenance service for the whole life from the date of purchase.
- 2.During the warranty period, the company will be responsible for free maintenance if any fault is caused by the quality of the product itself under normal use.
- 3.If it is damaged due to improper use or other non product quality problem, it is necessary to charge maintenance fees as appropriate , even during the warranty period.(Time fee, material fee plus freight)
- 4.If the monitor exceeds the warranty period,we will continue to provide free technical support and maintenance advisory service in case of tehcnical or quality problem.
- 5.If you need to return or exchange for special reasons, you must keep the packaging intact and the accessories complete.
- 6.Any artificial damage, water entry,collision causing breakage to series of monitor is not included in warranty.

## WARRANTY CARD

### USER INFORMATION

name:

phone:

add:

### SALES INFORMATION

sale date:

distributor name:

distributor tel:

### REPAIR LOG

repair date:

repair name:

issue:

result:

repaired

not repaired

return

# Certificate

This product is strictly inspected and meets the standard and is allowed to be sold.

Examination clerk:

---

The contents are subject to update without notice



# FIELD MONITOR

