



OWNER'S MANUAL

A MAJOR CAUSE OF FIRES IS FAILURE TO MAINTAIN REQUIRED CLEARANCES (AIR SPACES) TO COMBUSTIBLE MATERIALS. IT IS OF UTMOST IMPORTANCE THAT THIS PRODUCT BE INSTALLED ONLY IN ACCORDANCE WITH THESE INSTRUCTIONS.

WOODRIDGE™

**WELCOME TO THE WOOD-FIRED REVOLUTION.
WE WANT YOU TO GET THE MOST OUT OF YOUR TRAEGER.**

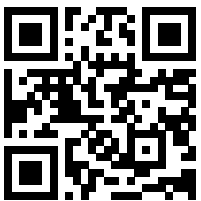

IMPORTANT SAFETY PRECAUTIONS

READ ALL INSTRUCTIONS BEFORE INSTALLING AND USING YOUR TRAEGER® GRILL

SAFETY ALERT KEY

- ▲ DANGER** Indicates an imminently hazardous situation which, if not avoided, may result in death or serious injury.
- ▲ WARNING** Indicates the possibility of serious bodily injury if the instructions are not followed.
- ▲ CAUTION** Indicates a potentially hazardous situation which, if not avoided, may result in minor or moderate injury.

A MAJOR CAUSE OF FIRES IS FAILURE TO MAINTAIN REQUIRED CLEARANCES (AIR SPACES) BETWEEN COMBUSTIBLE MATERIALS AND YOUR GRILL. IT IS OF UTMOST IMPORTANCE THAT THIS PRODUCT BE INSTALLED ONLY IN ACCORDANCE WITH THESE INSTRUCTIONS.

When properly operated and maintained, cooking with a hardwood fire on a Traeger® Grill brings years of enjoyment to you and your friends and family. Your new Traeger® Grill is specially designed to make cooking easier while giving you optimal performance with the most flavorful food.

Please read this entire manual before installation and operation. Anyone who uses this grill should also read the entire manual before operating it. Failure to follow these instructions could result in property damage, bodily injury, or even death. Contact local building or fire officials about restrictions and installation inspection requirements in your area. **Save these instructions.** If you are installing this unit for someone else, provide this manual for the owner to read and save for future reference.

▲ DANGER Carbon Monoxide Hazard

Burning wood pellets produces carbon monoxide which may lead to illness, serious injury, and/or death. Follow these guidelines to prevent this colorless, odorless gas from poisoning you, your family, your pets, or others:

- Only use your Traeger® Grill outside in a well-ventilated area. This grill is intended for **OUTDOOR USE ONLY**.
- **Never** use your Traeger® Grill in any enclosed area or any area without adequate ventilation.
- Know the symptoms of carbon monoxide poisoning: headache, dizziness, weakness, nausea, vomiting, sleepiness, and confusion. Carbon monoxide reduces the blood's ability to carry oxygen. Low blood oxygen levels can result in loss of consciousness and death.
- See a doctor if you or others develop cold- or flu-like symptoms while cooking or in the vicinity of this appliance. Carbon monoxide poisoning, which can easily be mistaken for a cold or flu, is often detected too late.
- Alcohol consumption and drug use increase the effects of carbon monoxide poisoning.
- Carbon monoxide is especially toxic to mother and child during pregnancy, infants, the elderly, smokers, and people with blood or circulatory system problems, such as anemia or heart disease.

▲ WARNING Fire Hazard

- When operating your Traeger® Grill, maintain a **MINIMUM** distance of 20 inches (50.8 cm) from the grill to any nearby combustibles, including wooden railings, home siding, window frames, furniture, trees, and trash receptacles, etc.

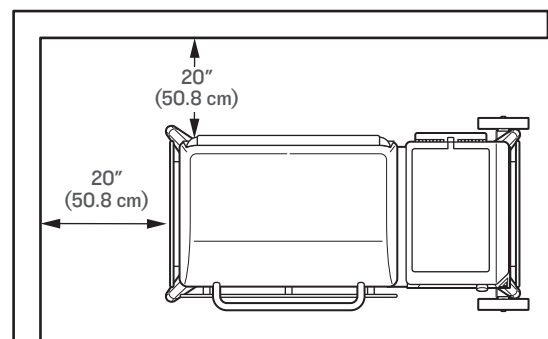

- Do not install or operate this grill indoors or under a combustible ceiling or overhang.
- Do not install or operate your Traeger® Grill on combustible floors or surfaces.
- Do not put a grill cover or anything flammable in the storage space area under the grill.
- To reduce the risk of fire, remove pots and pans from the appliance when it's operating unattended.

▲ WARNING Fire Hazard

- Keep your Traeger® Grill clean. Grease fires are caused by not properly maintaining your grill and failing to clean its Traeger® Grease Management

System on a consistent basis (see “Maintaining Your Grill” on page 34).

- Even if there is ample room in the grill, be cautious of loading excessive amounts of food or high fat content foods (e.g., bacon) that can release large quantities of flammable grease.
- Do not place food near the edges of the grill where grease drippings may miss the grease drip tray and fall to the bottom of the grill, where they could come into contact with embers from the firepot and ignite.
- Ensure the auger box is properly installed. If the auger box is not installed correctly, pellets will not flow properly into the firepot and may accumulate and cause damage to the grill.
- Always make sure the grease drain chute, heat baffle, and drip tray are properly seated on their locating brackets. If not installed correctly, direct heat and flame from the firepot could cause a grease fire or damage the Traeger® Grease Management System. Water could also enter and damage the Traeger® Grease Management System.
- **Never** use gasoline, lantern fuel, kerosene, lighter fluid, or other flammable materials to start or “freshen up” a fire.
- **Never** use or store flammable liquids or other combustibles materials near the grill.
- **Never** attempt to over-fire your grill by adding excess pellets or other combustible materials to the firepot or the hopper.

▲ DANGER In the event of a grease fire, ensure the grill lid and hopper lid are closed, and then immediately unplug the grill if you can do so safely. Move away from the grill until the fire is completely out and the grill has cooled down. Until the fire has extinguished and the grill has cooled off:

- **Do Not** move the grill;
- **Do Not** throw water on the grill;
- **Do Not** use salt or baking soda to put out a grease fire; and
- **Do Not** try to smother the fire.

With the grill lid and hopper closed, the fire will be starved of oxygen and burn itself out. Never keep the grill lid or hopper lid open during a grease fire; if the grill lid is open, use a non-combustible tool that will allow you to close the grill lid while keeping a safe distance from the grill. An all-class (class ABC) approved fire extinguisher should be used if a fire is not contained within the grill. If an uncontrolled fire does occur, immediately call the Fire Department. When the fire is completely out, allow the grill to cool completely. Remove everything from the inside of your grill, including all internal components (grill grates, drip tray, heat baffle), pots and pans, and food. Clean the entire grill, including any grease accumulation from the Traeger® Grease Management System and all ash and pellets from the grill and firepot (see “Maintaining Your Grill” on page 34). Place the grease drain chute, ember shield, heat baffle, grease drip tray, and grill grates back into the grill, restart the grill, and resume cooking.

▲ WARNING Fire Hazard

Always allow grill to cool completely before using the auger priming function.

▲ WARNING Burn Hazard

Ashes should always be completely cool before handling. Ashes should be placed in a metal container with a tight-fitting lid. The closed container of ashes should be placed on a noncombustible floor or on the ground, well away from all combustible materials, pending final disposal. Ashes should be retained in the closed container until they are disposed of.

▲ WARNING Burn Hazard

Many parts of the grill become very hot during operation. During operation of the grill and afterwards, care must be taken to avoid burns while the grill is hot.

- **Never** leave the grill unattended when young children or pets are present.
- **Never** move the grill when it is operating or hot. Let the grill cool thoroughly and close the grill lid before moving or attempting to transport. If you are transporting your grill in a vehicle after cooking on it, make sure the fire is completely out and the grill is cold before placing it in any vehicle.
- **Never** put water into the firepot; it will jam the auger.
- **Never** add pellets by hand to a hot firepot. This is dangerous and you may be seriously burned. If you run out of pellets and lose your fire while cooking, let the grill cool completely and start again. (See page 33, “Hopper Clean-out” instructions.)
- Grill grates and meat probes are extremely hot when heated. Please use caution when loading food onto the grill grates and when inserting, removing, or adjusting your meat probes.
- **Never** move the grill with the lid open. Always close the grill lid prior to moving.

▲ WARNING Smoke Hazard

- If there is a delayed start and the smoke from your grill changes from transparent white smoke to unusual billowing thick non-transparent white smoke that turns to a yellow-tinted smoke, immediately turn off your grill using the main power switch on the back of the auger box or unplug the power cord. **Do Not** initiate the shutdown cycle.

- **▲ DANGER Do Not** open the grill lid to air out the grill. Stay away from the grill until smoke clears and the grill completely cools. This may be the result of a pellet overflow condition, which is caused by partial ignition of pellets. If allowed to continue long enough, gases will build up, which can ignite. If these gases ignite they will combust all at once, making a loud noise that may startle and/or injure persons in the immediate vicinity of the grill, and the grill lid may open and close. This occurrence is sometimes referred to as a “grill burp” and should be avoided. If you have not properly maintained your grill, as described in “Maintaining Your Grill” on pages 34-36, a hazardous grease fire may also result.

IMPORTANT SAFETY PRECAUTIONS CONTINUED

- If a “grill burp” occurs, let the grill cool down completely, remove all internal components (including grill grates, drip tray, heat baffle, ember shield, and grease drain chute), and thoroughly clean all ash and pellets from the grill and firepot (see page 35, “Cleaning the Ash from Inside and Around the Firepot”) and ensure that grease and other buildup has been removed (see pages 34-36, “Maintaining Your Grill”). Remove all pellets from the pellet hopper. Clean all pellets out of the firepot. Fill hopper with new pellets and prime the auger.

- **⚠ DANGER** Do Not stick your hand in or near the auger located at the bottom of your pellet hopper. Severe injury will occur if the auger is turning and your hand is caught in the auger. Do not remove the wire guard in your pellet hopper. No maintenance should be performed on or around the auger while the grill is turned on or plugged into power.

⚠ WARNING Electrical Shock Hazard

Hazardous voltage is present, which can shock, burn, or cause death.

- Ground Fault Circuit Interrupter (GFCI) protection must be provided on the circuit(s) or outlet(s) to be used for the operation of this Traeger® Grill.
- Disconnect the power cord before servicing the grill unless otherwise noted in this Owner’s Manual.
- If using an extension cord, only use an extension cord suitable for outdoor use to prevent electric shock in accordance with the instructions and warnings accompanying that product. This type of cord is designated with “W-A” or “W” on the cord’s jacket, such as an extension cord of cord type: SW-A, SOW-A, STW-A, STOW-A, SJW-A, SJOW-A, SJTW-A, or SJTOW-A.
- If using an extension cord, be sure to use a No. 18 AWG cord.
- Do not modify the plug on your Traeger® Grill, the extension cord receptacle, or the extension cord plug in any way, including removing the ground (earth) prong.
- Make sure your extension cord is in good condition. Inspect extension cords prior to each use for loose or exposed wires and cut or worn insulation. Replace if damaged. Never use a damaged extension cord.
- Ensure that the power cord and extension cord are securely plugged together. Do not plug extension cords into one another.
- Keep extension cord clear of snow and standing water.
- Ensure that the power cord and extension cord do not create a tripping hazard. Do not route an extension cord through a window or doorway.
- When not in use, the extension cord should be removed and stored in a location protected from the sun and out of the reach of children.

⚠ CAUTION

- Never modify this grill or install any parts or components not authorized by Traeger for use with this grill. Any modification of this grill or installation of unauthorized parts or components will void the warranty and may create a safety hazard including, without limitation, a fire.
- Children should be supervised to ensure they do not play with the grill.

⚠ CAUTION Use Correct Pellets

- This grill is designed and approved only for all natural wood cooking pellets designed for wood pellet grills. Use of any other type of fuel in this grill will void the warranty, may lead to the auger becoming jammed, and may create a safety hazard.
- **FOR BEST RESULTS AND FLAVOR, USE GENUINE TRAEGER® BRAND HARDWOOD PELLETS.** Traeger pellets, when stored properly, have a mean heating value of approximately 8,000 BTUs per pound with approximately ≤2% ash. Do not use pellet fuel that does not meet these specifications or that has unnatural additives or binding agents.
- Always store wood pellets in a dry location, away from heat-producing appliances and other fuel containers.

⚠ WARNING Do Not Use Fuel Pellets

Never use heating fuel pellets in the grill because they may contain hazardous contaminants and additives and may damage the grill.

⚠ CAUTION Ambient Temperature

- When the ambient temperature falls below -20°F (-29°C) or rises above 120°F (49°C), damage to the controller’s display may occur.

⚠ WARNING Meat probes must be properly positioned to take accurate internal temperature readings of food. If positioned improperly, the temperature may not reflect the actual doneness, and undercooked food can increase the risk of food-borne illness.

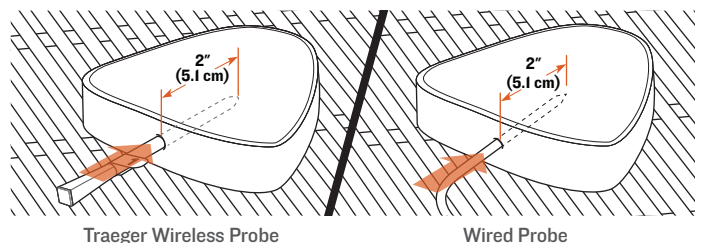

⚠ WARNING If the fire in the firepot goes out

while cooking, it is important to follow the steps below. Failure to do so may cause a hazardous “overfiring” of your grill due to an excess of unburned pellets in the firepot. This is often caused by improper start-up procedure and/or running out of pellets.

- Press the main power switch on the back of the auger box to OFF (O) and disconnect the power cord. Allow the grill to cool thoroughly. Open the lid and remove all food, grill grates, drip tray, heat baffle, ember shield, and grease drain chute.
- Remove all unburned pellets and ash from inside and around the firepot. (See instructions for proper handling and disposal of ash on pages 35-36.)
- Before replacing the grease drain chute, ember shield, heat baffle, drip tray, and grill grates, plug the power cord into a properly grounded/earthed electrical outlet protected by a Ground Fault Circuit Interrupter (GFCI), press the main power switch to ON (I), and start a cook. Pellets should fall into the firepot and the hot rod should begin to heat (it will start to turn red).

⚠ WARNING Do not touch the hot rod.

- When flames start to come out of the firepot, initiate a shutdown cycle by pressing and holding the shutdown button (lower left button) for 3 seconds. After shutdown cycle is complete, press the main power switch to OFF (O). Let the grill cool down. Now you're ready to place the grease drain chute, ember shield, heat baffle, drip tray, grill grates, and food back into the grill.

⚠ WARNING

- Press the main power switch to OFF (O) and disconnect the power cord before initiating any maintenance.
- Make sure that the grill is COLD and ashes are extinguished and COLD before checking the EZ-Clean™ Grease + Ash Keg.
- Accumulated grease is easier to clean off when the grill is still warm—not hot. **Be careful not to burn yourself. Always wear heat-protective gloves when cleaning.**
- A dedicated vacuum cleaner is the best way to remove ashes from the firepot, but this must be done with extreme care to avoid the risk of fire. Again, cleaning the ash from in and around the firepot should be done only when the grill and ashes are COLD.
- Cleaning the grill grates works best while they are still warm. **Be careful not to burn yourself. Always wear heat-protective gloves when cleaning.** We recommend keeping a long-handled cleaning brush near the grill. After removing your food, give the grill grate a quick brushing. It takes only a minute and it will be ready the next time you want to use the grill.

FCC Statement

Changes or modifications to this unit not expressly approved by the party responsible for compliance could void the user's authority to operate the device.

This device complies with part 15 of the FCC Rules. Operation is subject to the following two conditions: (1) this device may not cause harmful interference, and (2) this device must accept any interference received, including interference that may cause undesired operation.

This grill has been tested and found to comply with the limits for Class B digital device, pursuant to part 15 of the FCC Rules. These limits are designed to provide reasonable protection against harmful interference in a residential installation. This equipment generates, uses, and can radiate radio frequency energy and, if not installed and used in accordance with the instructions, may cause harmful interference to radio or television reception, which can be determined by turning the grill off and on. The user is encouraged to try to correct the interference by one or more of the following measures:

- Reorient or relocate the receiving antenna.
- Increase the separation between the device and receiver.
- Connect the device into an outlet on a circuit different from that to which the receiver is connected.
- Consult the dealer or an experienced radio/TV technician for help.

This device complies with FCC radiation exposure limits set forth for an uncontrolled environment. This device should be installed and operated with minimum distance of 8 in. (20 cm) between the device and a person's body.

This device complies with Industry Canada license-exempt RSS standard(s). Operation is subject to the following two conditions: (1) this device may not cause interference, and (2) this device must accept any interference, including interference that may cause undesired operation of the device.

SAVE THESE INSTRUCTIONS



WELCOME
TO THE
TRAEGERHOOD

TABLE OF CONTENTS

2 IMPORTANT SAFETY PRECAUTIONS

8 FLAVOR MATTERS

10 GETTING TO KNOW YOUR GRILL

13 QUICK REFERENCE GUIDE

14 FIRST THINGS FIRST

14 ONBOARDING PART 1: CONNECTING YOUR GRILL

16 ONBOARDING PART 2: SEASONING YOUR GRILL

19 EVERYDAY TRAEGERING

22 SHUTTING DOWN YOUR GRILL

23 HOW TO USE ADDITIONAL GRILL FEATURES

33 HOPPER CLEAN-OUT

34 MAINTAINING YOUR GRILL

36 TROUBLESHOOTING

37 OPERATING TIPS

37 SERVICE

38 WARRANTY

FLAVOR MATTERS. WOOD ISN'T JUST THE FUEL, IT'S THE **SECRET INGREDIENT.**

**TRAEGER
HARDWOOD**

**GOOD FOR ANYTHING
GREAT FOR:**

Flavor	Beef	Pork	Chicken	Seafood	Bread	Vegetables
APPLE			🐔	🐷	🍞	🍅
CHERRY	🐮		🐔	🐷	🍞	
HICKORY	🐮		🐔	🐷		🍅
MESQUITE	🐮		🐔		🍷	
PECAN	🐮		🐔	🐷	🍞	🍅
SIGNATURE BLEND	🐮		🐔	🐷	🍷	🍅

THE PERFECT **PAIRINGS**

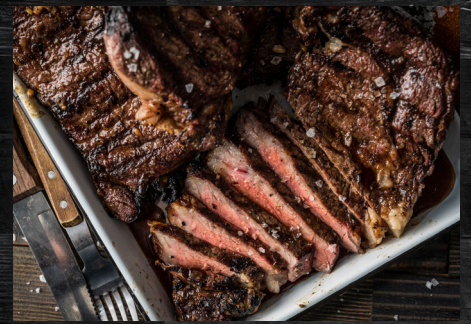

Bold cuts of beef need bold wood flavors to match, like hickory or mesquite.



Our signature blend pellets give your plain pizza pizzazz.



Pair your pie with cherry or apple pellets for a fruity, smoky finish.

NO FILLERS
BINDERS
NO WORRIES



AMERICAN HARDWOOD

ALL NATURAL HARDWOOD PELLETS

CONSISTENT PERFORMANCE & FLAVOR

HOW OUR PELLETS ARE MADE



1 Traeger pellets are made from **all natural hardwood** sawdust.



2 The sawdust is compressed into pellets using **heat and pressure**.



3 Pellets **fuel the fire and add flavor** to make meals unforgettable.

GETTING TO KNOW YOUR GRILL

Refer to the Assembly Guide to assemble your Traeger® Woodridge™ Grill.

PARTS AND FEATURES



PART	DESCRIPTION	PART	DESCRIPTION
1	UPPER GRILL GRATE	10	P.A.L. POP-AND-LOCK™ ACCESSORY RAILS
2	LOWER GRILL GRATE	11	LEGS
3	MODIFIRE® GRILL GRATE	12	HOOVES
4	DRIP TRAY	13	LID HANDLE
5	HEAT BAFFLE	14	LID
6	EMBER SHIELD	15	WiFiRE® CONTROLLER
7	GREASE DRAIN CHUTE	16	AUGER BOX
8	EZ-CLEAN™ GREASE + ASH KEG	17	ALL-TERRAIN WHEELS
9	WIRED MEAT PROBE	18	BRACE

WEIGHT CAPACITY

Pellet Hopper: 24 Pounds (11 kg)

PELLET HOPPER

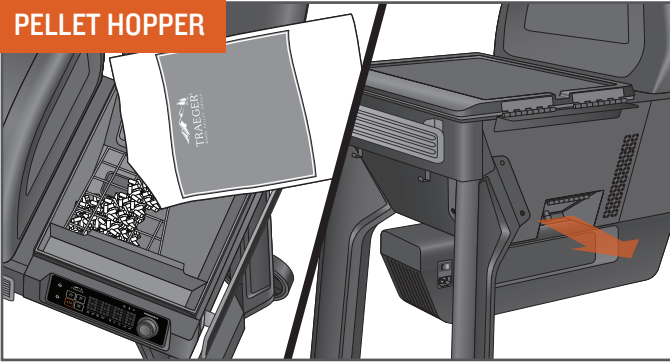

The hopper's 24 lb (11 kg) capacity allows for hours of cooking with no need to refill. Pellets can be emptied through the pellet release door on the back by unscrewing the knob.

USE ONLY TRAEGER HARDWOOD PELLETS. This product is developed and tuned using only Traeger pellets. Traeger pellets are crafted to meet strict quality and performance standards. Using pellets not manufactured by Traeger may result in inconsistent performance, poor flavor, and temperature inconsistency.

GRILLING SPACE

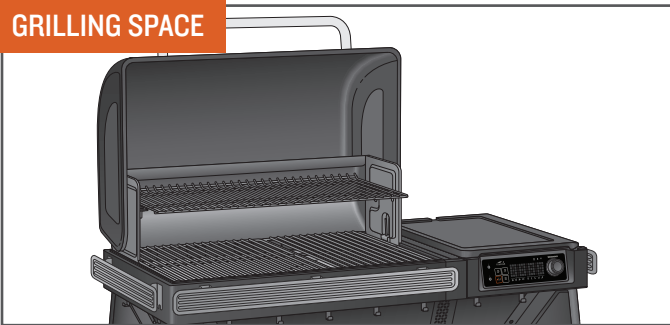

With 860 in.² (0.56 m²) of grilling space, your Traeger® Woodridge™ Grill has the real estate for party-sized orders of T-bones or racks of ribs, with enough room left over to handle those side dishes, too.

VERSATILITY

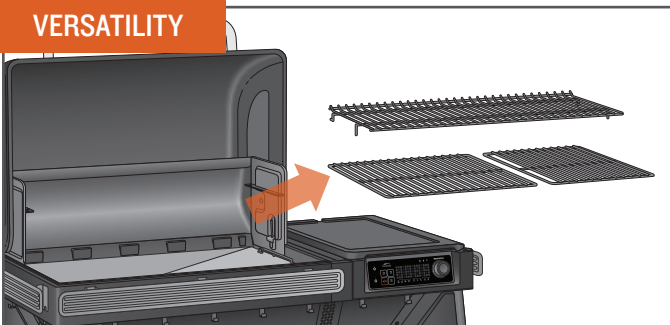

A removable upper grill grate and the lower ModifIRE® grill grate offer you the versatility you need to cook anything.



PRO TIP: The upper grate can be stored on back of the grill when cooking large items like turkeys (see page 34 for more information).

GRILL SHAPE

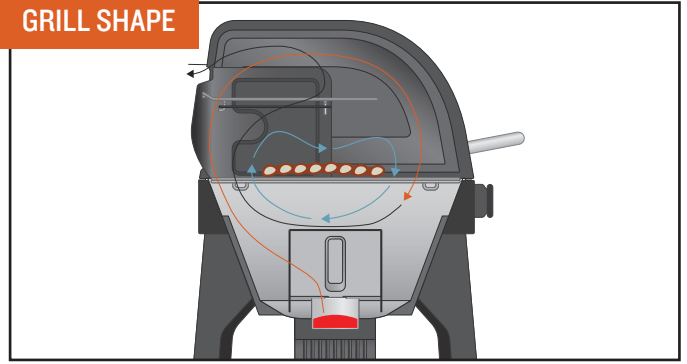

Your Traeger® Woodridge™ Grill has a unique barrel shape that helps funnel the smoke in and around your food for better, more flavorful results.

WiFi® CONNECTIVITY



Download the Traeger App and connect your grill to unlock the power of Traeger's WiFi® Technology. With the Traeger App you can remotely control your grill from anywhere, and your grill will also receive the latest and greatest firmware updates, keeping your grill operating at peak performance. Once connected, the Traeger App also lets you enable the Keep Warm Mode. See "Onboarding Part I: Connecting Your Grill" (page 14) for instructions on how to connect your grill to your phone.

NO FLARE-UPS

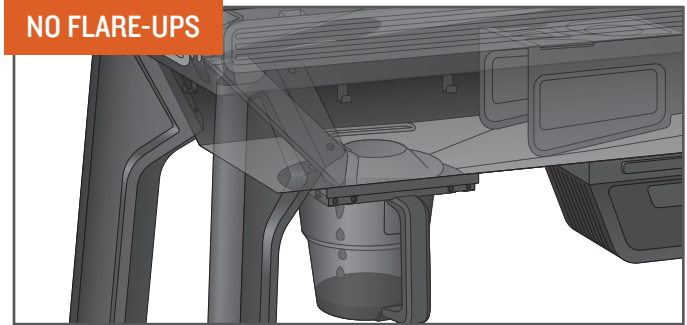

All grease is safely channeled into the EZ-Clean™ Grease + Ash Keg for disposal. This, combined with regular maintenance, prevents flareups and nasty fireballs from destroying your food.



PRO TIP: Keep your grill clean. See "Operating Tips" (page 37) and "Maintaining Your Grill" (page 34).

GETTING TO KNOW YOUR GRILL CONTINUED

YOUR WIFIRE® DIGITAL CONTROLLER Your Traeger® Woodridge™ Grill is equipped with a state-of-the-art Traeger Controller with WiFIRE® technology that is Wi-Fi-capable and Bluetooth®-enabled. Before you begin using the grill, familiarize yourself with the different features of the controller. Once the main power switch (located on the back side of the auger box) is ON (I), tap the ignite/shutdown button or turn the selection dial to wake the controller from sleep.

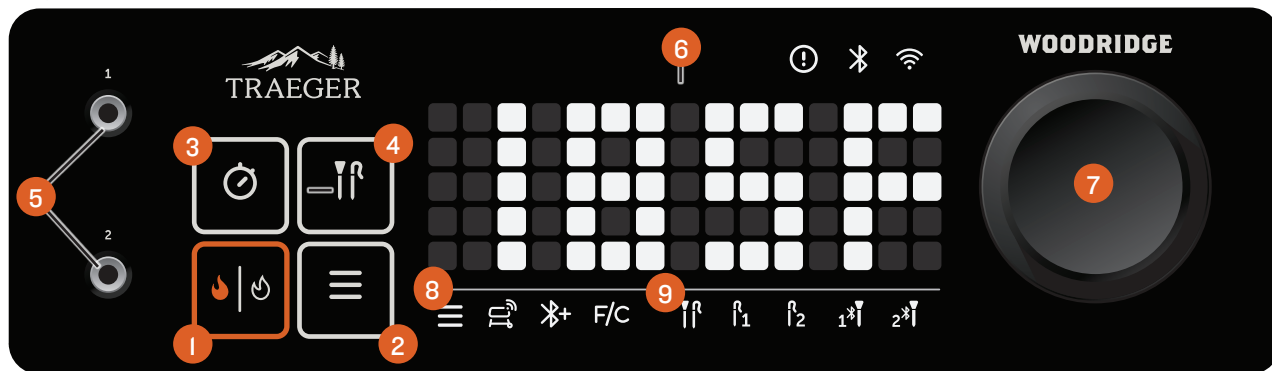

PRO TIP: On a good weather day, it is completely normal for a Traeger® Grill to experience temperature fluctuations of +/- 25°F. These fluctuations are actually a key component in creating the smoke flavor we at Traeger love. Your Traeger® Grill is designed to manage these fluctuations on its own. No need to change the set temperature! Any significant fluctuation could be the result of wind, air temperature, improper use, lack of grill maintenance, or opening the lid too often.

1 IGNITE/SHUTDOWN

Use this button to ignite your grill. If your grill is already running, press and hold this button to initiate a shutdown cycle.

2 MENU

You can connect your grill to WiFIRE®, connect your Traeger wireless probe, and change temperature units from this menu.

3 TIMER

The timer is for your convenience only; it does not affect grill operation. For example, if you need to braise your meat for 15 minutes, set the timer for 15 minutes. A tone will sound when the time is up.

4 PROBES

After connecting any wired probes via probe jacks or any Traeger wireless probes via the menu button, tap this button to interact with the connected probes. After tapping this probe button, use the selection dial to toggle between connected probes. When your desired probe lights up in the probe menu bar, press the dial to set/modify a probe goal alert for when a probe has reached the desired internal temperature.

5 WIRED MEAT PROBE JACKS

Use these jacks to plug in wired temperature probes.

6 STATUS DISPLAY

This dot matrix display shows current grill temperature, status of cook cycle, and all things related to grill control and function.

7 SELECTION DIAL

Rotate this dial to move up and down through the displayed menu. Press the center of the dial to make a selection.

8 MENU BAR



The menu bar icons light up when you tap the menu button to indicate which setting you are editing. Turn the selection dial to cycle through these selections.



Grill Connectivity Icon: Lights up when you are adjusting the WiFIRE® setting on your grill.



Add Bluetooth® Accessory Icon: Lights up when you are pairing Bluetooth® accessories.



F/C Icon: Lights up when you are adjusting your grill's temperature units to Fahrenheit or Celsius.

9 PROBE MENU BAR



The probe menu bar icons will light up as wired or Traeger wireless probes are connected, disconnected, selected, and activated for goal alerts. You can connect two wired probes and two Traeger wireless probes. Tap the probe button (upper right button to the left of the status display) to highlight connected probes in this probe menu one at a time. Use the selection dial to toggle between probes and press the dial to set/modify a probe goal alert for an individual probe. See the key below for probe states:

Off: Indicates that this wired or Traeger wireless probe is not connected.

Dim: Indicates that this wired or Traeger wireless probe is connected but not actively selected.

On: Icons will light up to full brightness when you tap the probe button. After tapping the button, turn the selection dial to see the selected probe icon turn to full brightness.

Blue: A probe icon will turn blue when a probe goal alarm has been set.

Blue + flashing: A probe icon will flash blue when a probe goal has been reached.

QUICK REFERENCE GUIDE

Be sure to check out the underside of the hopper lid for a quick reference to helpful information such as how to use your controller, how to clean your grill, and how to troubleshoot any error codes that may pop up. Scan the QR code here (or under your hopper lid) to view a Controller IOI video for a guided demonstration of your controller.

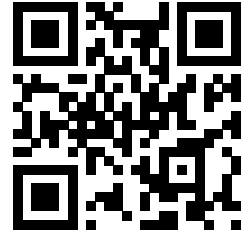

FIRST THINGS FIRST

- 1 Connect your WiFIRE® Grill to your home network via the Traeger App.
- 2 Season your grill.

ONBOARDING PART I: CONNECTING YOUR GRILL

Our dedication to delivering world-class products and experiences means we are constantly working to improve grill performance and features. We highly recommend connecting your Traeger® Woodridge™ Grill to WiFIRE® by following the instructions below. When your grill is connected and on, updates will automatically download, ensuring your grill is always operating at peak performance.

IMPORTANT:

- Make sure your smart device is running on the latest operating system and that Bluetooth® is turned ON.
- If using an Android device, turn on location services.
- To connect your grill to your home Wi-Fi, your grill must be powered on. Make sure the main power switch is pressed to ON (I) and lit up.
- Your home Wi-Fi router signal must be 2.4 GHz (a dual band router should also work). The 2.4 GHz band is currently industry standard for connected appliances. It has better range and penetrates walls/ceilings/obstacles better than 5 GHz, which your grill cannot recognize.

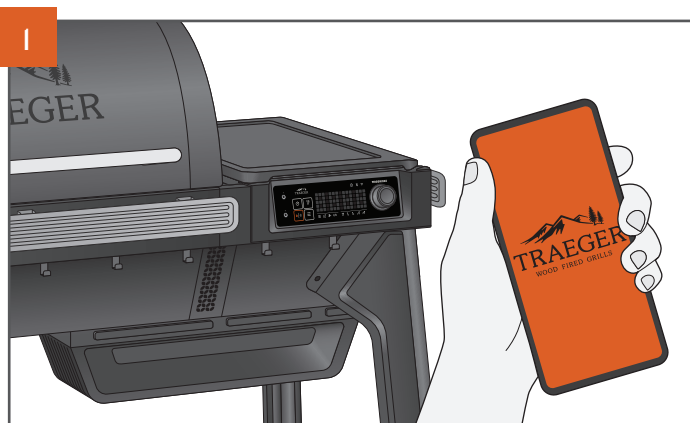
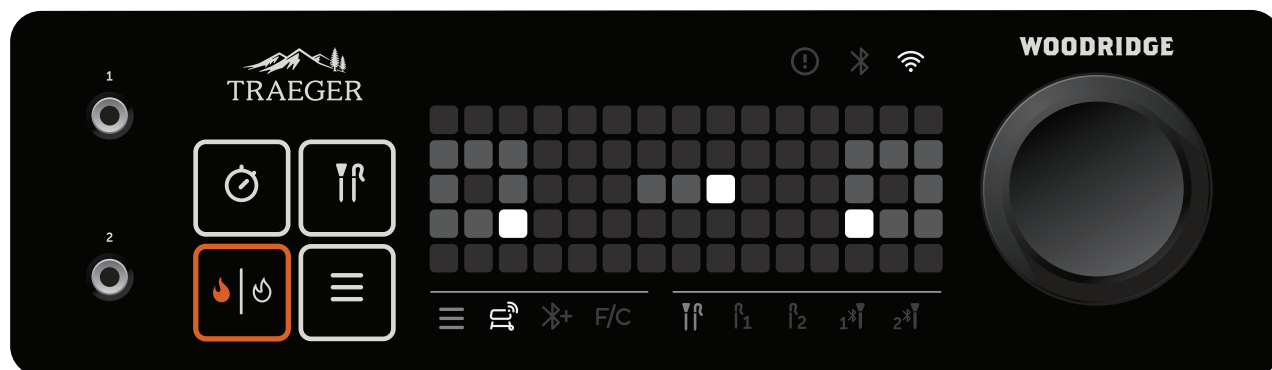

Go to the Apple App Store or Android Google Play Store to download the latest version of the Traeger App.

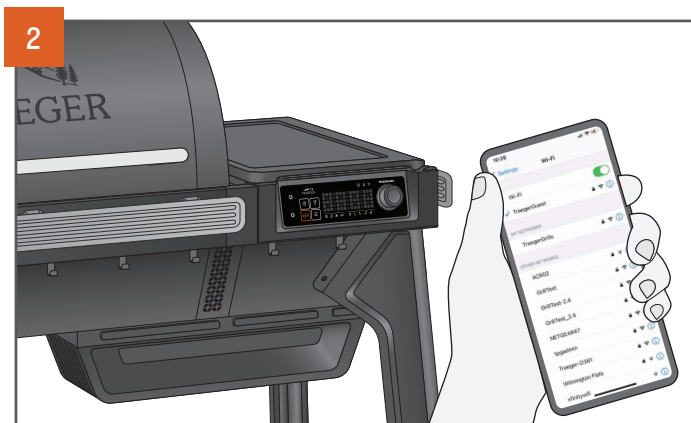

Ensure your smart device is connected to the Wi-Fi network to which you want your grill connected. The router signal must be 2.4 GHz, as the grill is not compatible with 5 GHz.



After powering on your grill, tap the menu button. You will see the Wi-Fi grill icon light up in the menu bar below the dot matrix, and an animation of a Wi-Fi signal with a question mark will be displayed. Press the selection dial to select this option and begin the connection process.

NOTE: You can navigate menu options by turning the selection dial after tapping the menu button. As you turn the dial, the menu bar icons below the dot matrix display will light up to indicate your selection.

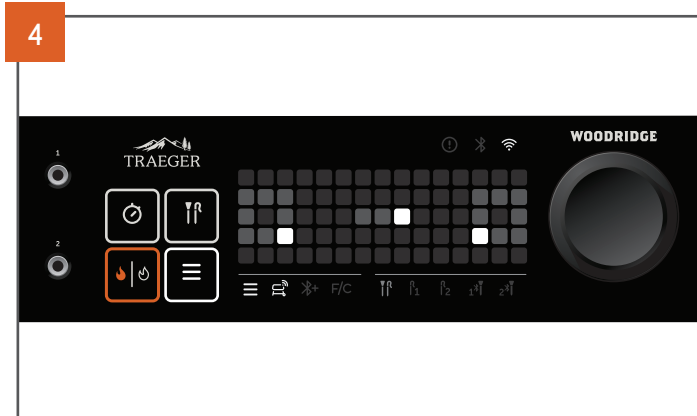

After selecting WiFIRE®, the pairing animation above will display on screen, indicating that your grill is broadcasting its Bluetooth® signal and is ready to pair. Open your smart device to the Traeger App and sign in to your account. On the home screen of the Traeger App, tap the grill icon in the lower center of the screen to start connecting.

Follow the instructions on the Traeger App to (1) pair your phone to your grill (via temporary Bluetooth® connection), (2) connect your grill to your desired 2.4 GHz home Wi-Fi network, and (3) complete the grill setup process.

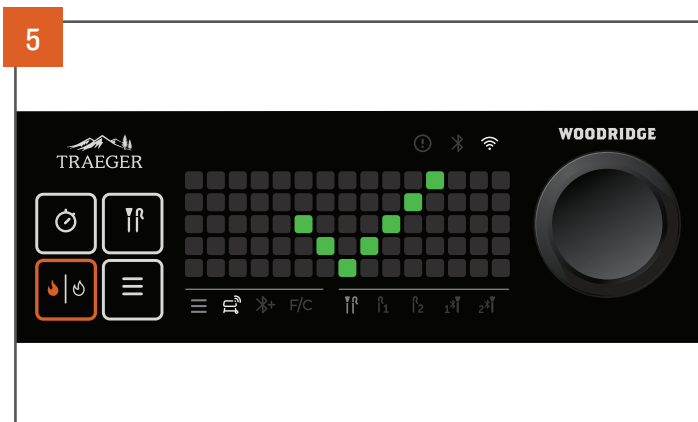

A green checkmark will display on your controller to indicate that you have successfully connected to WiFIRE®. The Wi-Fi icon in the top right above the dot matrix display will stay lit up when the grill is connected.



Once connected to WiFIRE®, you might see this animation on your screen. Don't turn off your grill until you see a green checkmark. This means that your grill is downloading and applying an update. Just like your smartphone, these updates keep your grill running smoothly, securely, and at peak performance. Once the update is done, you'll see a green checkmark and the grill will return to the idle mode – let's cook!

ONBOARDING PART 2: SEASONING YOUR GRILL



PRO TIP: Seasoning must be completed before cooking food on your grill. For more information, scan here to access the Seasoning Guide.



Before you can cook on your grill, the grill must be seasoned. This is a hands-off process in which the empty grill gets heated to a very high temperature. This seasoning cycle ensures the grill is cleaned of any factory residue, primed, and ready for optimal performance.

IMPORTANT:

- Make sure all components are properly installed in the grill and that all packaging/shipping materials are removed prior to seasoning.
- Do not wipe protective grease coating off of components before seasoning. This coating provides a more durable burn-in protective layer.

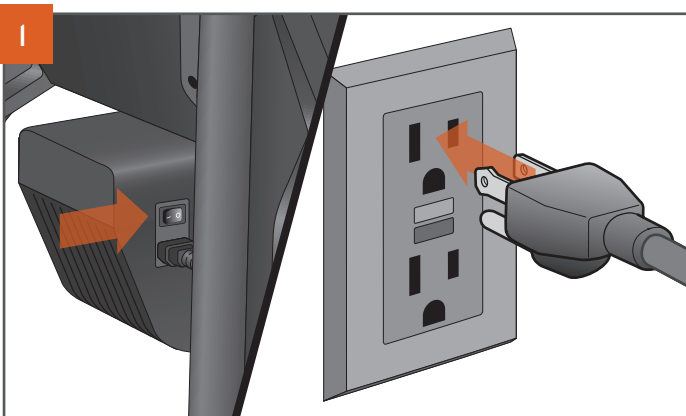
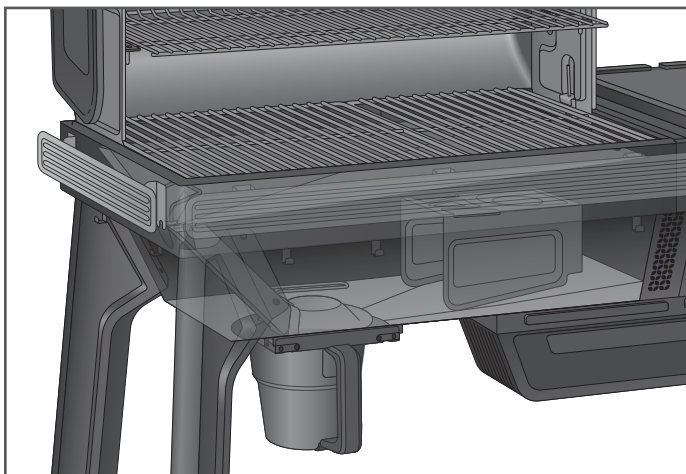

With the main power switch set to OFF (0), connect the power cord to your grill. Then plug the power cord into a properly grounded/earthed electrical outlet protected by a Ground Fault Circuit Interrupter (GFCI).

NOTE: Plug appearance may vary by region.



WARNING! ELECTRICAL SHOCK HAZARD
HAZARDOUS VOLTAGE IS PRESENT, WHICH CAN SHOCK, BURN, OR CAUSE DEATH.

- GROUND FAULT CIRCUIT INTERRUPTER (GFCI) PROTECTION MUST BE PROVIDED ON THE CIRCUIT(S) OR OUTLET(S) TO BE USED FOR THE OPERATION OF THIS TRAEGER® GRILL.

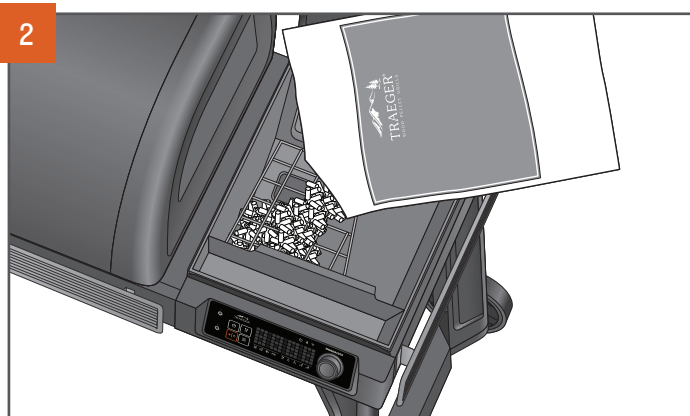

To add pellets, open the hopper lid and inspect for any foreign objects in the auger. Fill the hopper with pellets at least to the safety grate and close the lid.

USE ONLY TRAEGER HARDWOOD PELLETS. This product is developed and tuned using only Traeger pellets. Traeger pellets are crafted to meet strict quality and performance standards. Using pellets not manufactured by Traeger may result in inconsistent performance, poor flavor, and temperature inconsistency.

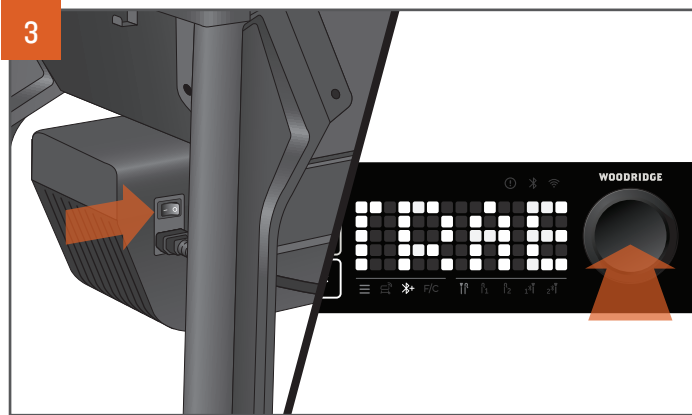

Press the main power switch, located on the back of the auger box, to ON (I). Press the selection dial to wake up the controller. "TRAEGER" will scroll across the screen, indicating the grill is on.



Turn the selection dial to set the grill's temperature to 350°F, then press the dial. Press the ignite/shutdown button.



PRO TIP: This seasoning process is important to ensure proper grill performance. Make sure that all internal components have been properly installed prior to this seasoning cycle and that there is no food on the grill grates during this cycle.



The grill temperature will display as it increases to the set temperature.

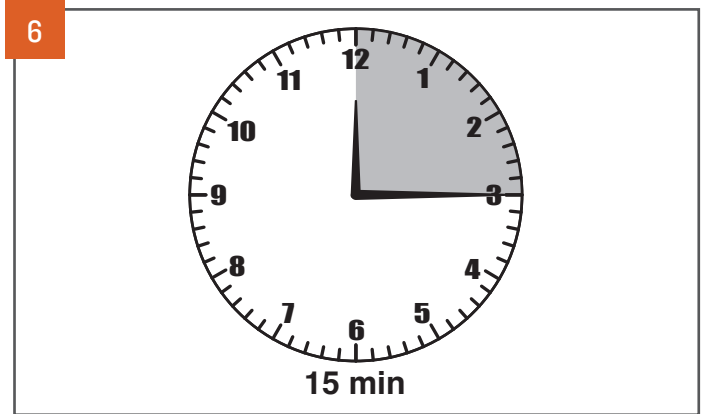

Once the grill has reached 350°F, let it run for 15 minutes. While the grill is seasoning, you may see dark or excessive smoke and ash; this is normal and will not be as significant on future startups.



After 15 minutes at 350°F, increase the temperature to 500°F.

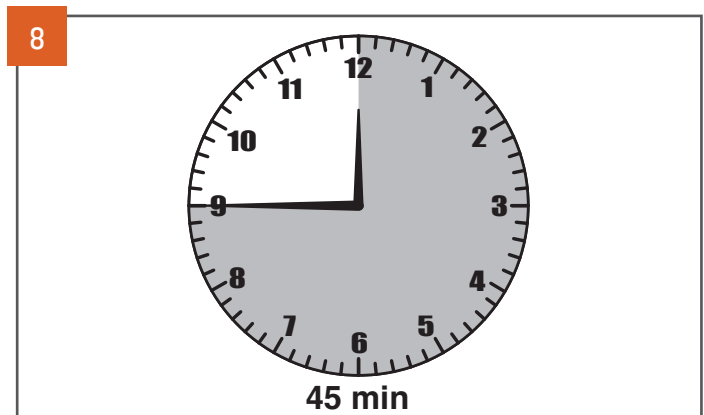

Once the grill has reached 500°F, let it run for another 45 minutes to ensure seasoning is completed properly.

NOTE: Getting to first-time seasoning temperature may take up to an hour.

ONBOARDING PART 2: SEASONING YOUR GRILL CONTINUED

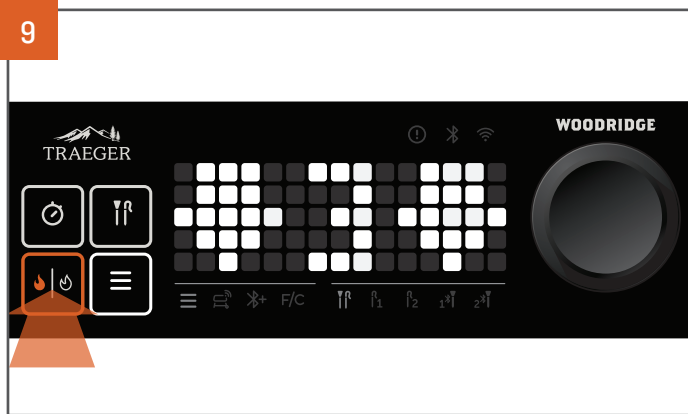

After 45 minutes at 500°F, shut down the grill and let the shutdown cycle complete. To shut down your grill, press and hold the ignite/shutdown button or the selection dial for three seconds until the display shows the shutdown animation.

NOTE: Always initiate a shutdown cycle after each and every cook.



A countdown timer begins while the grill is shutting down. You will hear the fan continue to run.

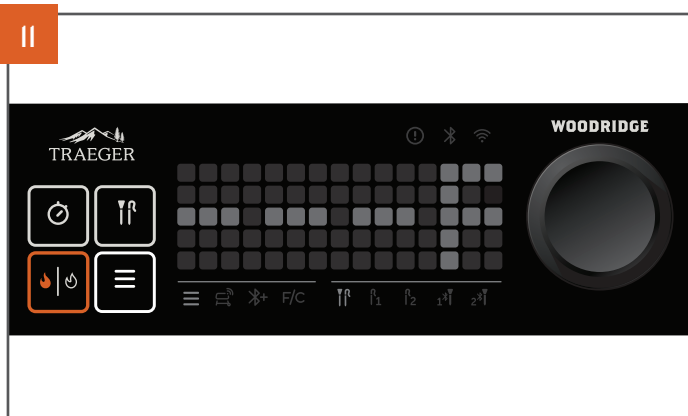

Once this countdown is complete, the shutdown cycle is complete.

NOTE: It is normal to observe ash on the drip tray and/or grill grates after seasoning. Simply wipe away ash on grill grates prior to your first cook.

EVERYDAY TRAEGERING

Become your neighborhood's backyard grilling hero in no time! Get familiar with how to cook on your new Traeger® Woodridge™ Grill and learn how to use your grill's features to the max.

PRE-GRILLING CHECKLIST (YOU WILL NEED TO BEGIN WITH THESE STEPS EVERY TIME YOU USE YOUR GRILL)

1. Is your grill clean?

Check to make sure that your grill is clean. Open the lid, brush any residual grease or debris down into the EZ-Clean™ Grease + Ash Keg and empty for best performance. Regularly inspect your grill for accumulated grease. Grease fires are caused by not properly maintaining the grill and failing to clean the Traeger® Grease Management System (TGMS) on a consistent basis.

2. Is everything in its place?

Be sure to open the lid and ensure auger box is properly installed and screws are tight, your drip tray is properly installed, and your EZ-Clean™ Grease + Ash Keg and Ember Shield are in place.

3. What's on the menu and are your grill grates in the right place?

Different grill grate levels will produce slightly different results. To optimize by style of cooking, we recommend:

a. **Lower grill grate** for high heat cooking (searing, roasting, grilling, etc)

b. **Upper grill grate** for low and slow cooking (smoking, baking, braising)

c. **IMPORTANT:** If you're cooking to high heat, what was the last thing you cooked? If it was a greasy dish (bacon, brisket, buttered-up corn, etc), make sure to give the grill a good wipe down to clean up any grease. Not maintaining or cleaning up grease and then cooking at a high temperature is the cause of grease fires.

4. Is your grill empty and the lid closed?

Ignite and preheat your grill with the lid closed and no food on the grates. Adding food before your grill reaches the set temperature can result in the grill taking longer than usual to achieve your desired temperature.

5. Do you have enough Traeger Hardwood Pellets?

USE ONLY TRAEGER HARDWOOD PELLETS. This product is developed and tuned using only Traeger pellets. Traeger pellets are crafted to meet strict quality and performance standards. Using pellets not manufactured by Traeger may result in inconsistent performance, poor flavor, and temperature inconsistency.

6. Is your grill connected to the app and updated to the latest and greatest firmware?

Connecting to the Traeger App not only allows you to remotely monitor and control your grill, but also ensures that your grill is operating on the latest firmware. Much like your smart device, when a new firmware package is released, your grill will automatically begin downloading this new release. If the grill is connected and powered on, the update will occur immediately. If the grill is connected but powered off, the grill will automatically update the next time you power on your grill. We recommend keeping your grill plugged in and powered on to keep update interruptions to a minimum and to ensure your grill is always operating on the latest firmware. For instructions on checking your firmware version, visit Support at traeger.com.



PRO TIP: Once connected, the Traeger App also lets you enable the Keep Warm Mode. This mode is only available through the app.

7. Cooking a protein?

Use a probe and cook to an internal temperature instead of relying on a suggested time. Trust us—it's the easiest, most foolproof way to get delicious, consistent and repeatable results, every cook.

EVERYDAY TRAEGERING CONTINUED

HOW TO COOK ON YOUR TRAEGER

Follow these steps to set and adjust your grill's temperature.



With the lid closed, press the main power switch located on the back of the auger box to ON (I). Press the selection dial or tap the ignite/shutdown button to wake the grill. A splash screen will appear after a few seconds as the grill powers on.

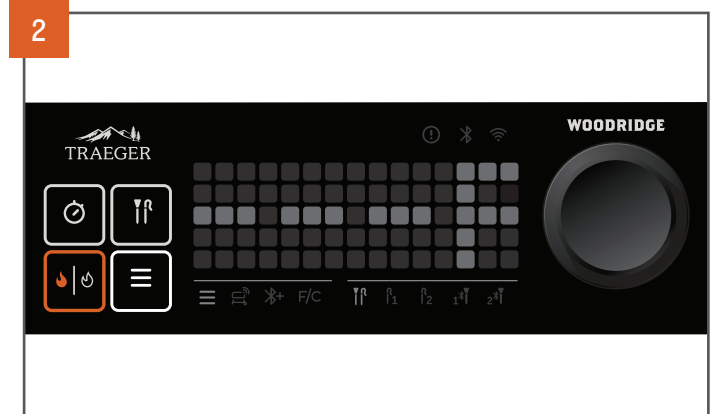

The dot matrix displays three dashes and F or C. This is the home screen when your grill is idle. You can set a grill temperature directly from this screen.

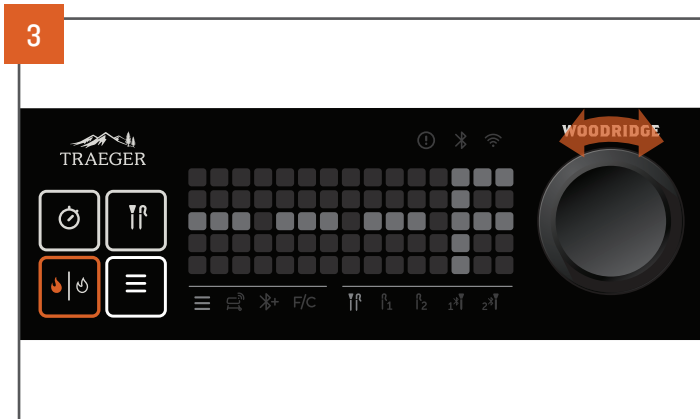

To select a temperature, rotate the selection dial to the right to increase the temperature, or to the left to lower the temperature.

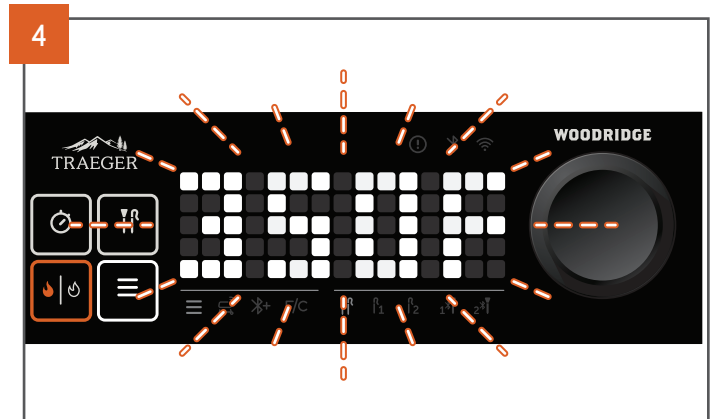

The selected temperature will blink on and off.

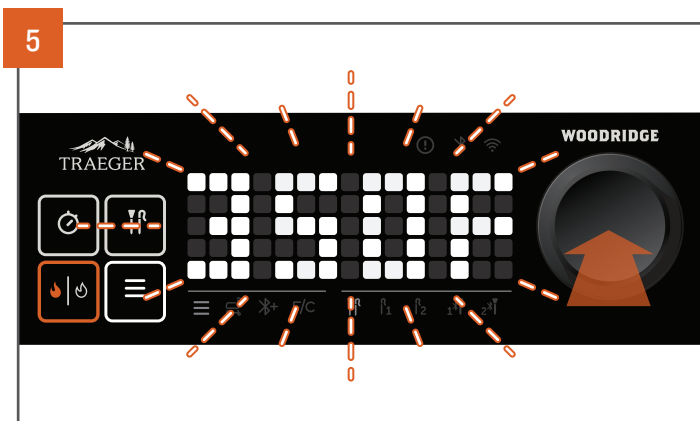

While the temperature is blinking, press the center of the selection dial to select your desired temperature.



Once your temperature is selected, the temperature will change from white to orange, indicating that your set temperature is locked in. The ignite/shutdown button will now blink. Tap this button to start ignition. The grill will now ignite and preheat automatically to reach the temperature you set.



While the grill is preheating, the controller will display an animated arrow next to the temperature, indicating preheating mode. The current temperature will climb in 5-degree increments as the grill heats up.

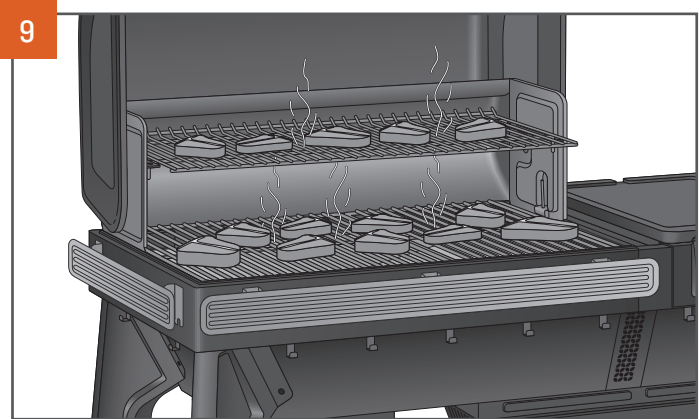

You are now ready to load up your grill with food and get cooking.

TIPS:

- Keep the grill closed during the preheat cycle so that the grill can reach the desired set temperature.
- Wait until the preheat cycle is complete before you begin cooking your food. Opening the lid before the desired temperature is reached can prevent you from getting the best cooking results.
- Adding food too early can result in the grill taking longer than usual to achieve your desired set temperature.
- Traeger® Woodridge™ Grills provide real-time temperature readings in five-degree increments, and you should expect to see fluctuations in temperature.



PRO TIP: Cooking to a desired internal food temperature is the best-kept secret for getting great results.



Once the grill has reached the set temperature, the controller will no longer display the preheating arrow animation, and the current temperature will continue to hover within +/- 25°F of the set temperature. These small temperature swings are completely normal for daily wood pellet grill use and are the natural result of fanning and monitoring the flame. Do not open the lid or adjust the set temperature before it is reached.

SHUTTING DOWN YOUR GRILL

The shutdown cycle is crucial to the success and high-quality grill performance of your Traeger® Woodridge™ Grill. The shutdown cycle gets your grill properly set up for your next cook, and prevents future adverse events.

IMPORTANT: Always initiate a shutdown cycle after each and every cook.



Press and hold the ignite/shutdown button down for three seconds. Your controller will then count down from 3. When it reaches 0, the shutdown cycle will begin.



A countdown timer begins. You will hear your fan running; this is normal.

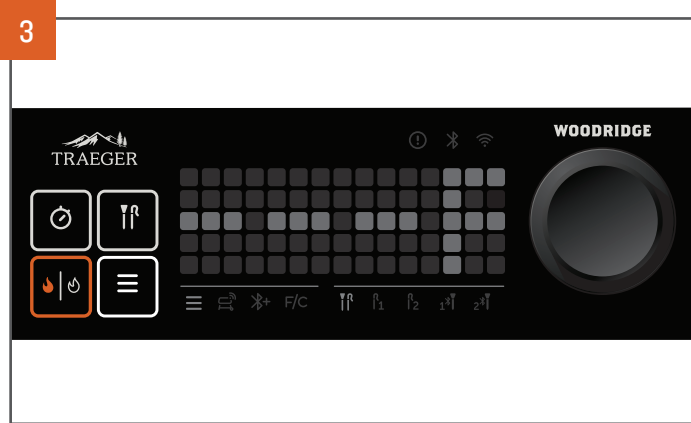

Once shutdown is complete, your grill will enter standby mode until you are ready to use it again.

NOTES:

- The shutdown cycle minimizes your risk for future adverse events like backburn. Backburn occurs when the fire from the firepot burns pellets in the auger tube, causing the fire to burn back into the hopper.
- The shutdown cycle will run for approximately 15-25 minutes, depending on the previous set temperature. Allow the shutdown cycle to complete for the proper operation of your grill. Do not press the main power switch on the back of the auger box to OFF (0) or unplug your grill prior to completion.
- After your grill completes the shutdown cycle, it will automatically enter sleep mode. The grill should be left on and in sleep mode to download any firmware updates as they are released.

HOW TO USE ADDITIONAL GRILL FEATURES

(Getting the Most Out of Your Grilling Experience!)

TRAEGER APP

The Traeger App puts a world of flavor at your fingertips. Control your grill anytime, anywhere with WiFIRE®. Access over 1600 wood-fired recipes, learn from the pros, and receive curated content that helps you become a better cook—all right from your phone.

Connecting your grill also ensures your grill operates at peak performance. When connected and powered on, your grill will automatically be updated with the latest and greatest firmware updates as they are released.

You will need a home internet Wi-Fi connection for your Traeger® Woodridge™ Grill. Your smart device must be running the latest iOS or Android operating system. If you leave the range of your Wi-Fi networks with your device, a data plan is required. The grill must remain connected to the internet to receive the latest operating, safety, and security updates. See page 14 for instructions on how to use your smart device to pair your Traeger® Grill to the Traeger App.



PROBES

The Traeger® Woodridge™ Grill comes with one wired meat probe for monitoring internal meat temperatures. For wireless monitoring, there is the Traeger wireless probe, which is sold separately. Follow the instructions below to connect your Traeger wireless probe to your Traeger® Woodridge™ Grill.

PAIRING YOUR BLUETOOTH® TRAEGER WIRELESS PROBE (sold separately)

Pairing a probe is a one-time process. Once you have successfully paired a Traeger wireless probe to your Traeger® Woodridge™ Grill, the grill will recognize this probe when it is active (charged and removed from dock) and within range of your grill.

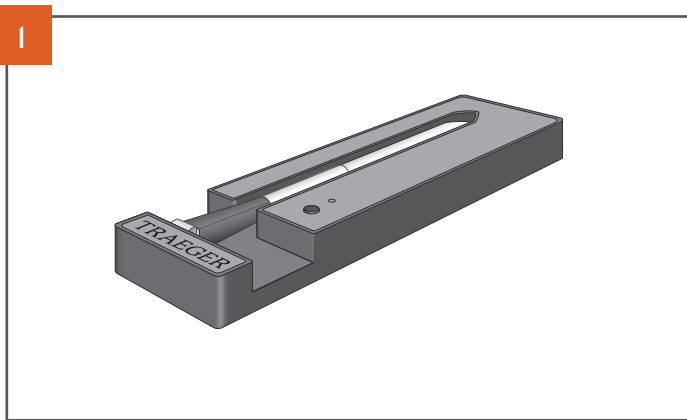

Make sure the battery in your charging dock is properly installed and full by pressing the button on the front of the unit. The green LED above the button will light up. If it does not, check the battery compartment and remove any packaging to ensure the battery is properly installed. With the battery properly installed, let your Traeger wireless probe charge in the dock according to the instructions included with your probe.

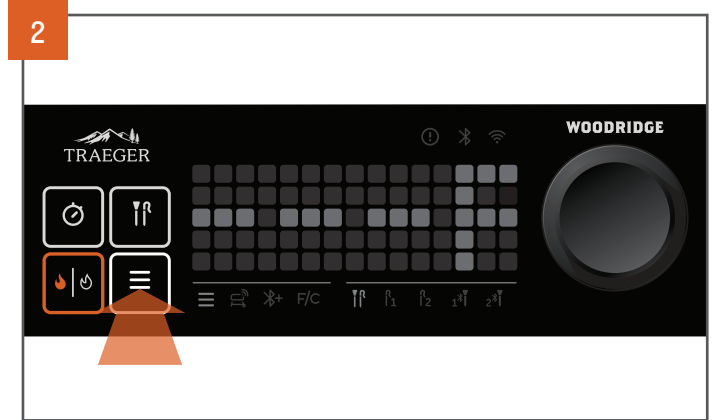

Grill should be powered on and in an idle (not-cooking) state. In this state, tap the menu button.

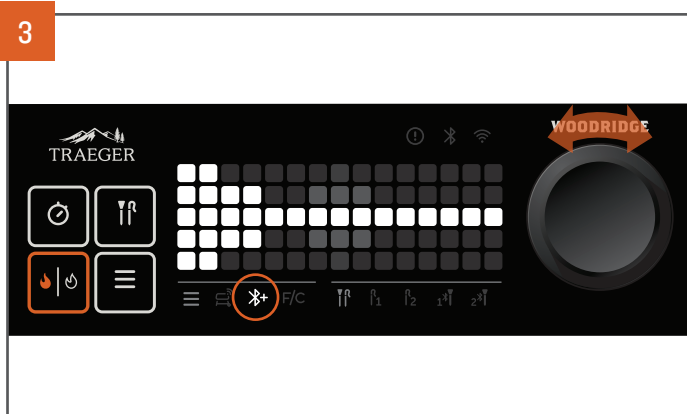

While in the menu, turn the selection dial until the Add Bluetooth® Accessory icon lights up in the menu bar and the probe pairing animation above displays on screen.

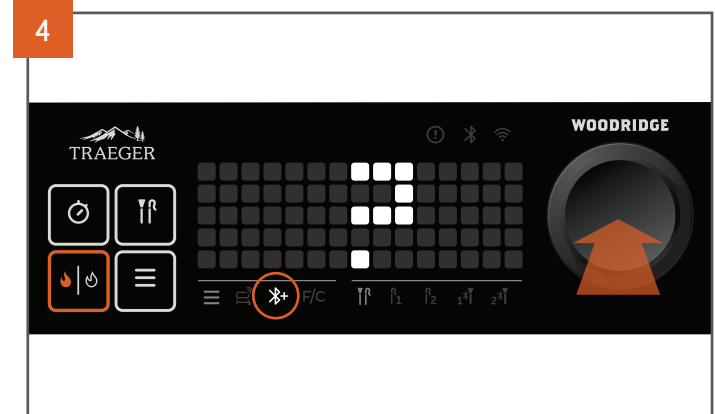

Press the selection dial to select this option and begin the pairing process.

HOW TO USE ADDITIONAL GRILL FEATURES CONTINUED

PROBES CONTINUED

PAIRING YOUR BLUETOOTH® TRAEGER WIRELESS PROBE CONTINUED



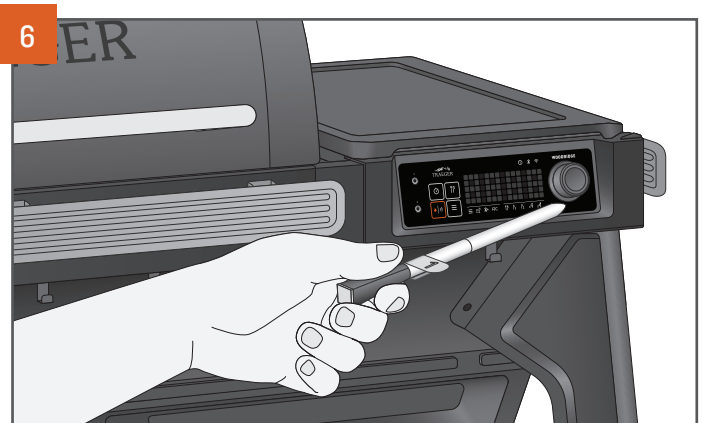

The screen will display a pairing animation, indicating that the grill is currently searching for Traeger wireless probe Bluetooth® signal.

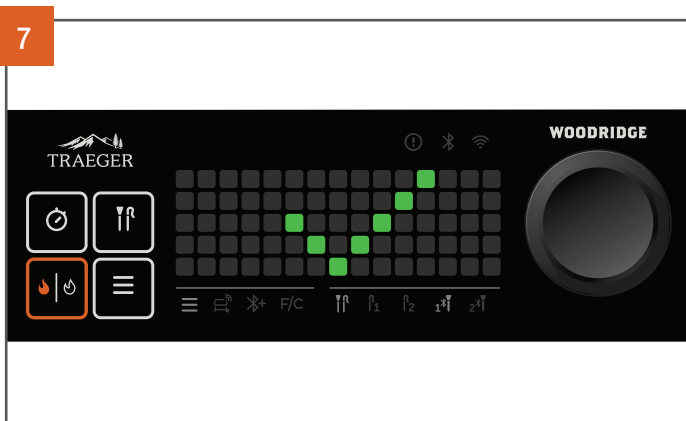

Remove the Traeger wireless probe from the dock and hold it close (within 3 ft) to your Traeger® Woodridge™ Grill controller.

IMPORTANT: Traeger wireless probes must be removed and paired one at a time and in range of the grill. This will ensure that the grill will only pick up one Bluetooth® signal at a time. A probe begins broadcasting its signal when it is removed from its dock.



When the grill successfully connects to your Traeger wireless probe, you will see a green checkmark animation on the screen and a probe icon with a number 1 or 2. If this is the first probe you are pairing with the grill,  will light up. If it is the second probe paired to the grill,  will light up.

On the probe menu bar beneath the screen, you will now see this probe icon lit up (full brightness), indicating that this probe is connected. After five seconds, the probe icon will dim, indicating that it is no longer selected, and the grill will return to the Add Bluetooth® setting. You can repeat steps 1-6 to pair a second probe.

NOTE: Pairing is a one-time process. Once you have successfully paired a Traeger wireless probe to your Traeger® Woodridge™ Grill, the grill will recognize this probe when it is active (charged and removed from the dock) and within range of your grill.

If pairing was not successful, an error message is displayed. This could be caused by one of the following:

- A. The probe battery could be dead. Check to make sure the probe is fully charged and try again. This may require replacing the battery on your probe dock and allowing some time for the probe to recharge (we recommend four hours).
- B. The grill could be picking up multiple Traeger wireless probe Bluetooth® signals. Make sure that only one probe is removed from its dock and within range of the grill controller (the closer the better). Return any other Traeger wireless probe to its dock to stop it from sending its Bluetooth® signal.
- C. The probe is already paired to another Traeger® Woodridge™ Grill. Probes will only pair with one grill at a time. If you'd like to stop using a probe with another grill and start using it with this grill, you will need to use the grill control to "forget" the probe from the prior grill before initiating the pairing process with this grill (see next section).

REMOVING A PREVIOUSLY PAIRED TRAEGER WIRELESS PROBE FROM YOUR GRILL



If you'd like to disconnect or unpair your Traeger wireless probe, tap the probe button.



Turn the selection dial to highlight the Traeger wireless probe that you'd like to disconnect, either probe 1 or 2.

NOTE: If you want to disconnect a wired probe, simply remove the probe connection from the jack.



When the desired probe is highlighted in the probe menu bar beneath the dot matrix display (probe 1 shown above) and the current probe temperature is displayed, press and hold the selection dial for three seconds.

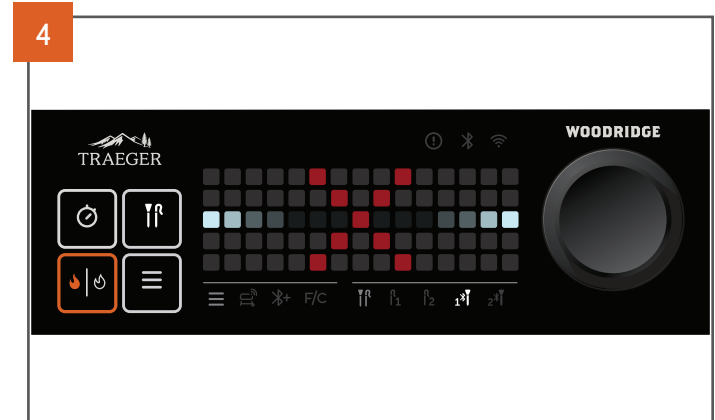

If your probe has been successfully disconnected, you will hear an audible "disconnected" tone and the display will show this animation. The probe icon in the probe menu bar will flash and then turn off.

CONNECTING YOUR WIRED PROBES

Up to two wired probes can be connected using the physical probe jacks on the left of the controller.

Once plugged in, a wired probe can be used by tapping the probe button, just like the Bluetooth® Traeger wireless probe.



HOW TO USE ADDITIONAL GRILL FEATURES CONTINUED

PROBES CONTINUED

SETTING A GOAL TEMPERATURE ALARM FOR YOUR PROBES

Never overcook or undercook your proteins again! Use your controller or the Traeger App to set a probe goal alarm to alert you when your probe has reached a target internal temperature. You can set a goal for either the wired probes or your Traeger wireless probe.

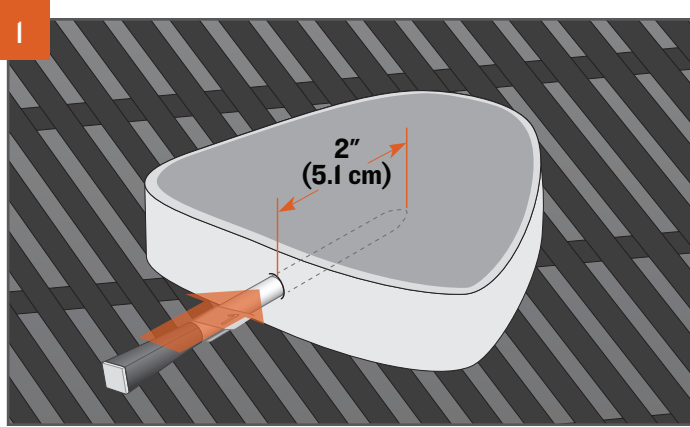

Insert the probe up to the notch, into the thickest part of the protein—avoid touching any bones or particularly fatty portions of the protein. The probe needs to be in the protein at least two inches (5.1 cm). This probe may not be suitable if you cannot insert the probe two inches (5.1 cm) into the thickest part of the protein. After your probe has been inserted, load your food onto the preheated grill.



Tap the probe button.

NOTE: After tapping this button, if you see “- - -” displayed instead of a probe temperature, this means that no probes are currently connected or active. See “Pairing Your Bluetooth® Traeger Wireless Probe” for instructions on how to connect/pair.



From the probe menu, use the selection dial to cycle through and highlight any of your probes that are currently connected and active. You will see the icon light up in the probe menu bar, and the current probe temperature will be displayed.



When the desired probe is highlighted in the probe menu bar, (in this example, Bluetooth® probe 1), press the selection dial to select it.

5

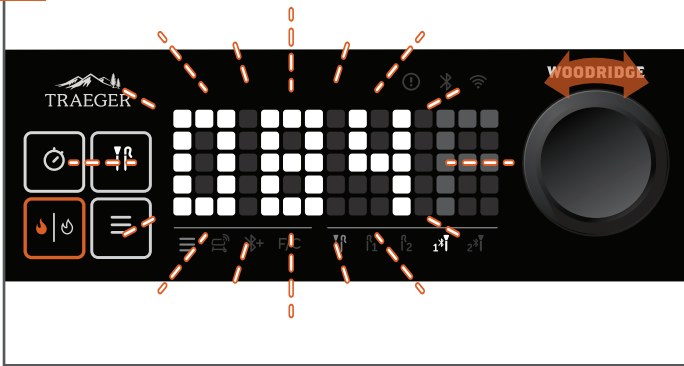

After pressing the selection dial, the numbers on screen will flash, indicating you are in the selection mode. Turn the selection dial to your desired internal goal temperature.

6



Press the selection dial to confirm.

7



The goal temperature on screen will turn blue when the selection has been confirmed. After confirming this goal, the display will now alternate between showing the goal temperature (in blue) and the current probe temperature (in white) when this probe is highlighted. This probe icon in the probe menu bar turns to blue to indicate that a goal has been set. The controller will alert you when you have reached your target temperature.

HOW TO USE ADDITIONAL GRILL FEATURES CONTINUED

EDITING OR CANCELING A GOAL TEMPERATURE ALARM



EDITING: If you'd like to edit a current probe goal alarm, simply tap the probe button, turn the selection dial to highlight your desired probe in the probe menu bar, and press the dial. Turn the selection dial to the desired temperature and press to lock in your setting.



CANCELING: If you'd like to cancel a probe goal alarm, simply tap the probe button and use the selection dial to navigate to the desired probe (in this example, Bluetooth® probe I). Then press and hold the selection dial for three seconds. After pressing and holding the selection dial, the goal alarm will be canceled and the numbers will revert back to white and display the current probe temperature reading.

KEEP WARM FUNCTION

Keep Warm can be used as a temperature setting shortcut. Selecting this mode will maintain the grill temperature at 180°F (82°C).

NOTE: The Keep Warm function is not designed to cook your food to proper food safety standards.



Keep Warm can only be enabled from the Traeger App. (See page I4 for instructions on how to get your grill connected to WiFIRE®). Make sure your grill is on and actively running. Once connected, find the Keep Warm mode on your Traeger App and tap to select.



After selecting Keep Warm on your app, you will see an animation play on the grill screen and the grill will begin lowering the temperature to 180°F (82°C).



Once the grill has reached 180°F (82°C), the Keep Warm animation will take the fourth digit place on screen until you change the temperature or turn off the grill.

HOW TO USE ADDITIONAL GRILL FEATURES CONTINUED

TIMER

You can set, monitor, edit, or cancel a timer on your controller or within the Traeger App.

TO SET THE TIMER



Tap the timer button.

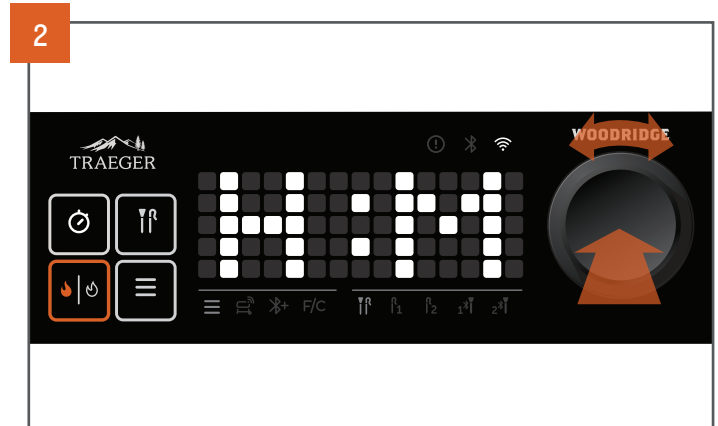

H and M will flash briefly, indicating that you can set hours on the left and minutes on the right. Hours will flash first. Turn the selection dial to your desired hours, then press the dial to lock in hours. If you do not wish to set any hours, press the selection dial when the screen displays 00:00.

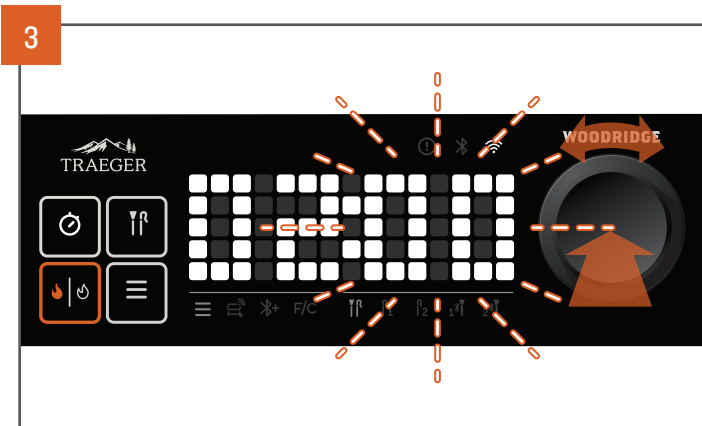

Minutes will now flash. Turn the selection dial to your desired minutes, then press the dial to lock in the minutes.

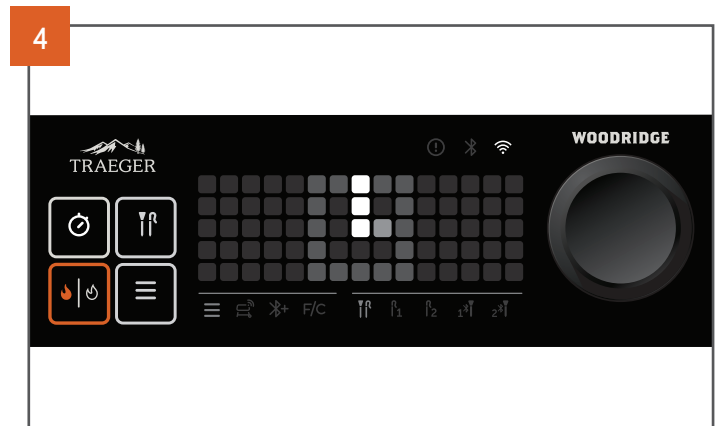

A timer animation will play on screen to indicate that the timer was successfully set. The timer LED button will stay lit up while a timer is set. With timer selected, the remaining time will display on the screen. Once the remaining time is under an hour, the display will switch from showing "hours : minutes" to "minutes : seconds."

TO CANCEL THE TIMER



Tap the timer button so that the time remaining is displayed.

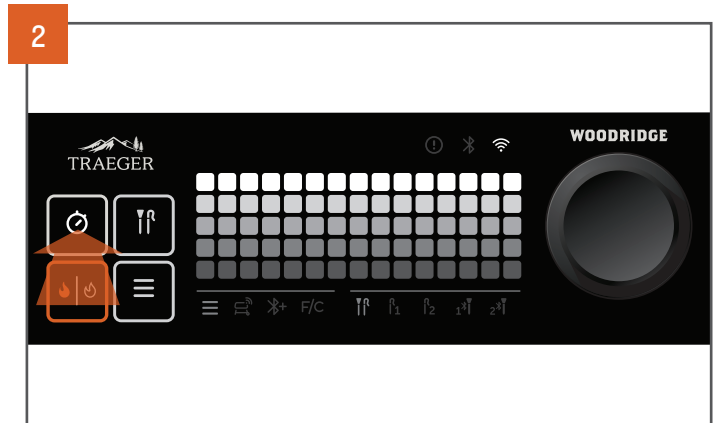

Press and hold the timer button for three seconds to clear the timer.

CHANGING TEMPERATURE UNITS

1

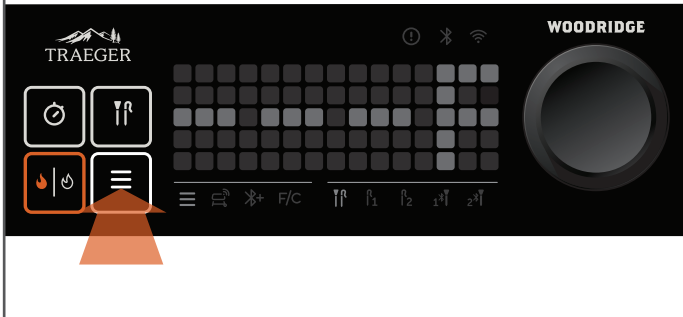

Tap the menu button.

2

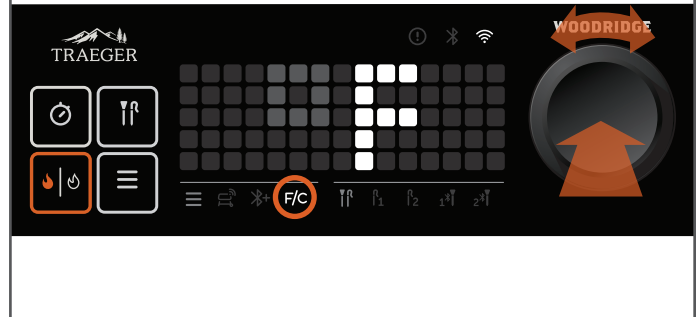

Turn the selection dial until the "F/C" icon is lit in the menu bar. Press the dial to enter the selection mode.

3



Turn the selection dial to the desired selection: F for Fahrenheit or C for Celsius.

4

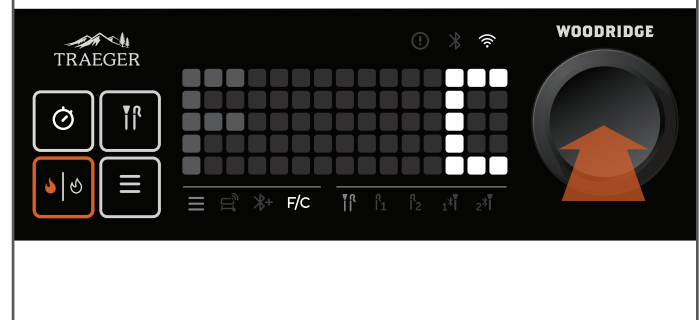

Press the selection dial to lock in and confirm your selection.

5

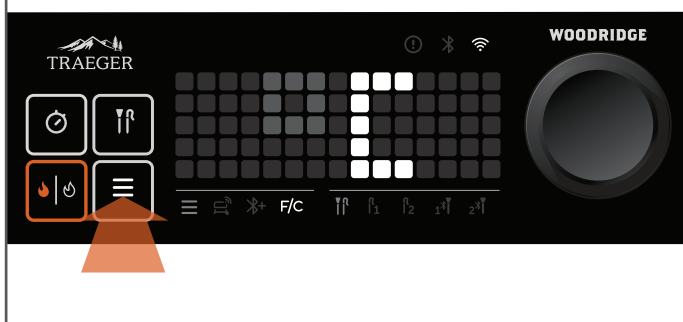

Return to your idle or home screen by tapping the menu button. The selected units will be displayed.

HOW TO USE ADDITIONAL GRILL FEATURES CONTINUED

AUGER PRIMING FUNCTION

Priming the auger will allow you to manually move the auger. This function should be used if you need to clear any pellets from the auger tube or if you want to fill the auger with pellets after running out of them.



WARNING! FIRE HAZARD
ALWAYS ALLOW GRILL TO COOL COMPLETELY BEFORE USING THE AUGER PRIMING FUNCTION.

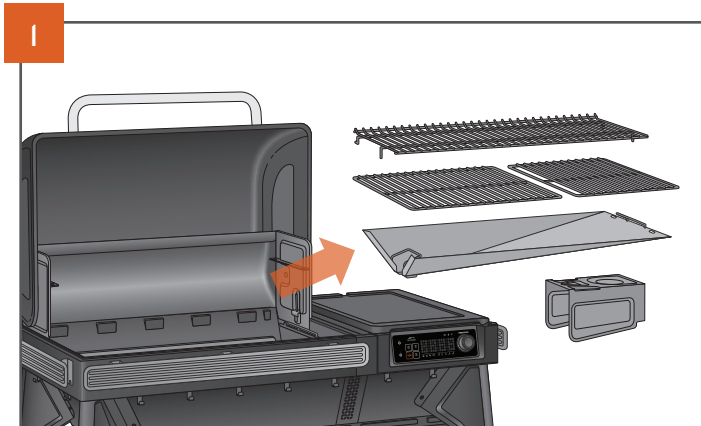

1 Make sure the grill is idle and not cooking. Remove the grill grates, drip tray, and heat baffle.

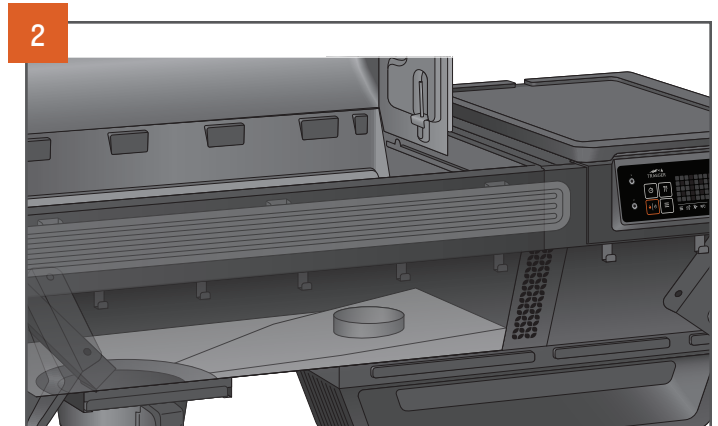

2 Make sure the firepot is not full of pellets.

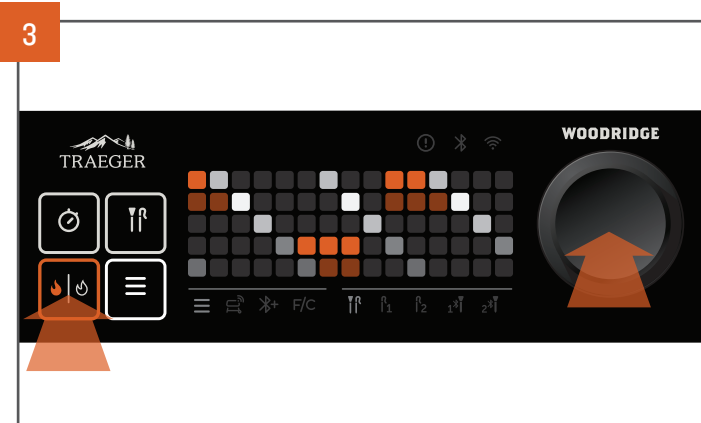

3 When the grill is in idle (display showing: --- F), press and hold both the ignite/shutdown button and the selection dial. The auger will begin to move and the screen will display the auger moving animation.

If you are using this function to bring fresh pellets to the firepot, continuing holding the ignite/shutdown and selection dial together until pellets begin to fall into the firepot; then release both buttons. If you are using this function to clear pellets from the firepot, continue holding the ignite/shutdown and selection dial together until all pellets have exited.

Once the auger has been primed, check the firepot and remove anything that fell in. Ensure your firepot is clean and empty before ignition.

HOPPER CLEAN-OUT

Your Traeger® Grill has a hopper clean-out system that allows you to remove pellets from the pellet hopper or quickly change from one pellet flavor to another without making a mess.

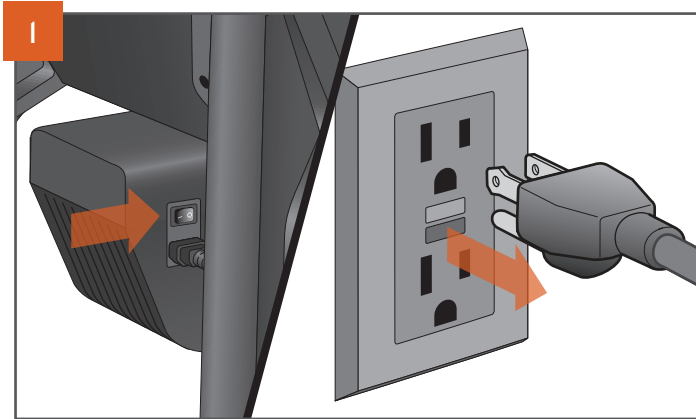

Press the main power switch to OFF (0) and disconnect the power cord. If the grill is still hot, allow it to cool completely.

NOTE: Plug appearance may vary by region.



WARNING! ELECTRICAL SHOCK HAZARD
HAZARDOUS VOLTAGE IS PRESENT, WHICH CAN SHOCK, BURN, OR CAUSE DEATH.

- GROUND FAULT CIRCUIT INTERRUPTER (GFCI) PROTECTION MUST BE PROVIDED ON THE CIRCUIT(S) OR OUTLET(S) TO BE USED FOR THE OPERATION OF THIS TRAEGER® GRILL.

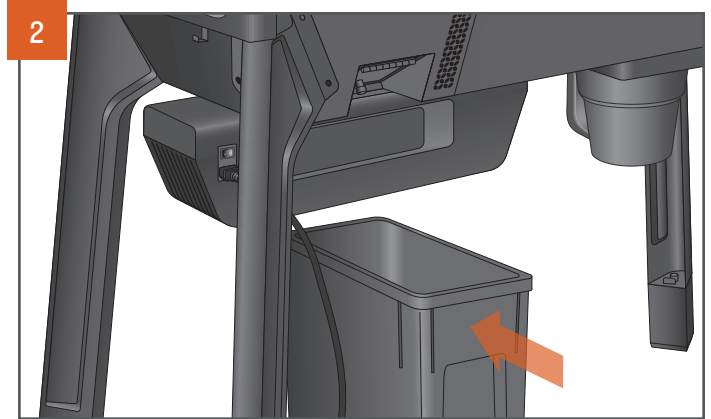

Before emptying the hopper, make sure that the Traeger® StayDry™ Pellet Bin (sold separately) is placed directly underneath the pellet release door.

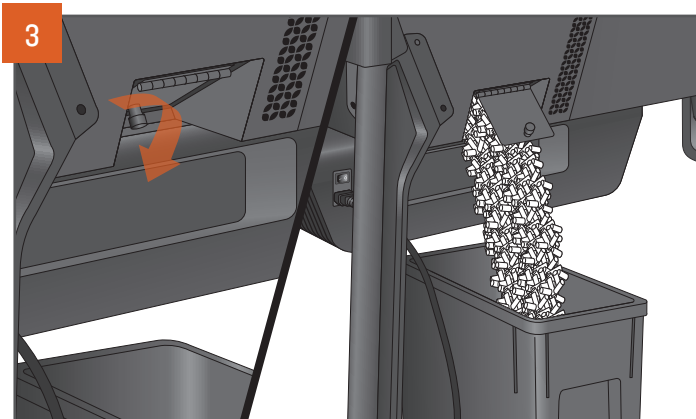

Unscrew the knob on the back of the auger box and open the pellet release door. Pellets will empty into the StayDry™ Pellet Bin. Vacuum out any remaining sawdust from the hopper.



WARNING! DO NOT EMPTY OUT THE HOPPER UNTIL GRILL HAS COMPLETELY COOLED AND THE POWER IS OFF; OTHERWISE, PELLETS MAY BE VERY HOT.

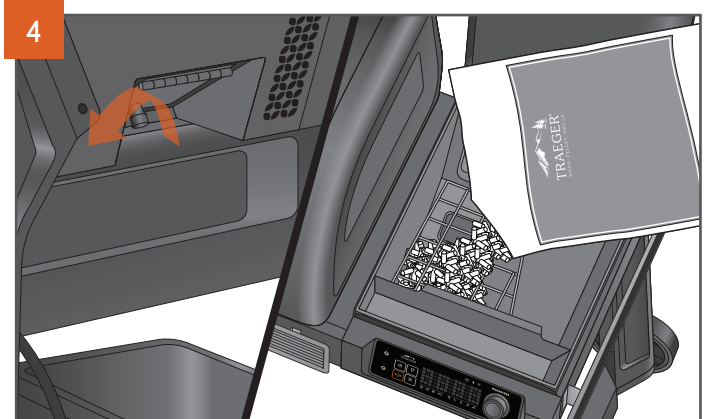

Once the hopper is empty, close the door and tighten the knob. Refill the hopper with a different flavor of TRAEGER HARDWOOD PELLETS.



WARNING! DO NOT PLACE YOUR HAND IN THE HOPPER PAST THE SAFETY GRATE.

MAINTAINING YOUR GRILL

Do you love bacon, sausage, and brisket? We do, too, but after cooking these fattier cuts, it's more important than ever to remove grease from the grill. Fortunately, it's easy to do. When the grill has cooled to a warm temperature, scrape grill grates and wipe up this grease from the drip tray (be careful not to burn yourself). This will ensure that everything runs smoothly the next time you fire up, especially if you plan to cook something hot and fast!

⚠ WARNING **Fire Hazard:** Grease fires are most frequently caused by failing to properly maintain the grill by not cleaning the grease from the grill on a consistent basis.

⚠ WARNING Press the main power switch to OFF (0) and disconnect the power cord before initiating any of the maintenance below.

1. BEFORE EACH COOK:

Remove any buildup from the drip tray, or replace the drip tray liner. Check the EZ-Clean™ Grease + Ash Keg, empty if full, and replace with a new EZ-Clean™ Grease + Ash Keg liner.



PRO TIP: Cover the drip tray only with genuine Traeger branded Drip Tray Liners. Using foil or other materials will significantly impact the performance of the grill and could damage the drip tray or grill.

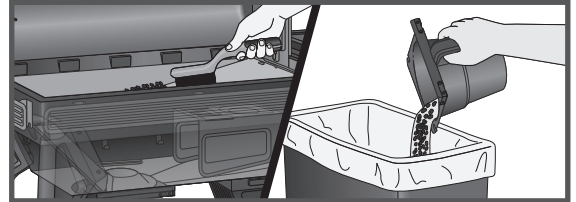

2. AFTER EACH COOK:

After shutdown, remove any excess food from the grates while still warm. Scrape all grease into the EZ-Clean™ Grease + Ash Keg. Reinstall the Ember Shield.

NOTE: When scraping out grease, do not use a metal scraper.

⚠ WARNING To avoid injury, ensure all ash is cooled before cleaning.

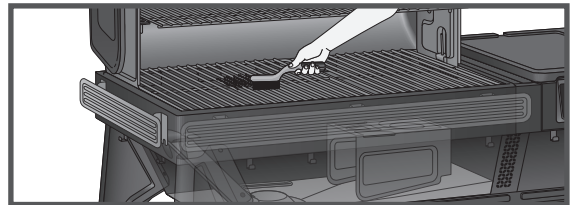

3. MONTHLY:

Check the firepot and remove ash in, around, and underneath. Vacuum the ash from the inside of the firepot. Scrape creosote from the backsplash and the back of the grill lid. Do a final wipe-down of the grill cavity with Traeger® Grill Cleaner. Remove and clean out the grease drain chute. Remove ash by sweeping it into the EZ-Clean™ Grease + Ash Keg.

NOTE: When scraping out creosote, do not use a metal scraper.

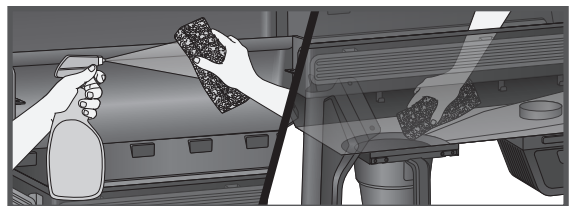
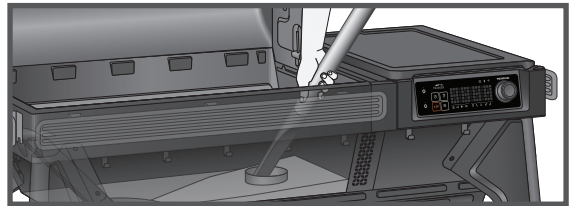
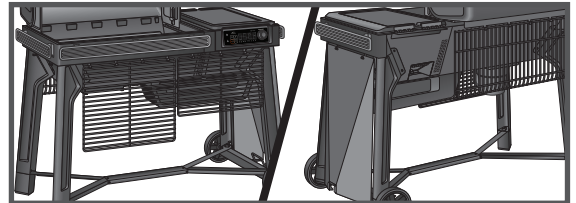

4. AS NEEDED:

Replace the EZ-Clean™ Grease + Ash Keg liner when full.

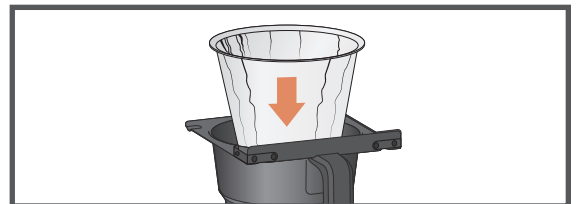

5. CHECKING THE EZ-CLEAN™ GREASE + ASH KEG BEFORE EVERY COOK:

⚠ WARNING Make sure that the grill is COLD and ashes are extinguished and COLD before checking the EZ-Clean™ Grease + Ash Keg.

⚠ WARNING Failure to empty the EZ-Clean™ Grease + Ash Keg could result in a serious fire.

Underneath the grill body there is a keg that collects both ash and grease. **This should be checked before every cook and emptied when full.** To remove and check the keg, simply grab the keg with two hands and slide it out. Remove the disposable liner and replace with a new one. See Step 10, Disposal of Ashes, for proper ash disposal.

NOTE: Traeger's keg liners will help keep this a clean and easy task.

6. CLEANING YOUR TRAEGER® GREASE MANAGEMENT SYSTEM ("TGMS"):

During your cooks, grease drippings will fall onto (i) the grease drip tray and be channeled into (ii) the grease drain chute, (iii) to be collected in the EZ-Clean™ Grease + Ash Keg. These three components are the components of the Traeger® Grease Management System (TGMS). Grease will accumulate in all of these locations and should be regularly cleaned to reduce the risk of fire.

How often you need to clean the TGMS depends on the fat content of your food. Fattier foods will require cleaning of the TGMS more often, and sometimes you will need to clean the TGMS after every cook.

Visible pieces of food and bits of hardened grease or other buildup indicate a need for cleaning.

All components of the TGMS should be inspected before each use for signs of grease buildup.

⚠ WARNING Accumulated grease is easier to clean off when the grill is still warm—not hot. **Be careful not to burn yourself. Always wear heat-protective gloves when cleaning.**

Clean the grease out of the grease drain chute. We recommend cleaning this location regularly.

Remove all grill grates. This will provide access to the grease drain chute opening inside the grill. Scrape the grease accumulated on the drip tray down through the grease drain chute using a stiff, nonmetallic tool. Much of the loosened grease can be pushed down through the grease drain chute and will fall into the EZ-Clean™ Grease + Ash Keg. Wipe up remaining grease residue with paper towels or disposable rags.

Regularly clean the grease out of the grill on the interior bottom and sides. If grease is allowed to build up, a grease fire could result.

Scrape the grease accumulation from inside the grill using a stiff, nonmetallic tool. Much of the loosened grease can be removed using paper towels or disposable rags. Excessive scraped-off ash residue can be cleaned using a vacuum cleaner as described in Step 9 (below) when cleaning the firepot of ashes.

Inspect and clean the heat baffle for any grease or debris.

7. CREOSOTE REMOVAL:

When wood pellets are burned slowly, they produce tar and other organic vapors that combine with expelled moisture to form creosote. The creosote vapors condense in the relatively cool exhaust vent of a slow-burning fire. As a result, creosote accumulates on the exhaust vent lining. When ignited, creosote makes an extremely hot fire. Airborne grease particles will travel through the cooking chamber, and some of this airborne grease will accumulate on the exhaust vent lining, similar to creosote, which could contribute to a fire.

Periodically scrape the creosote and grease accumulation from the back of the backsplash and back of the grill lid. Once the creosote and grease residue have been loosened from the interior lining and ventilation gaps in this downdraft system, much of it can be removed with paper towels or disposable rags. Do not spray water or other liquid cleaners onto the inside of your grill to remove creosote.

NOTE: Inspect the Traeger® Exhaust System every time you refill the hopper with pellets to determine when a creosote and/or grease buildup has occurred.

When creosote or grease has accumulated, it should be removed to reduce the risk of a fire.

8. OUTSIDE STORAGE:

⚠ CAUTION If the grill is stored outside, care should be taken to ensure that water does not get into the pellet hopper. Wood pellets expand greatly when wet and will jam your auger. Always cover your grill when not in use with a Traeger® Grill Cover. This custom-fit cover can be purchased at traeger.com.

9. CLEANING THE ASH FROM INSIDE AND AROUND THE FIREPOT (AFTER APPROXIMATELY 20 HOURS OF COOKING):

⚠ WARNING Make sure that the grill is COLD and ashes are extinguished and COLD before cleaning the ash.

⚠ WARNING Disposal of ashes should be done only according to the following instructions.

Excess ash in the firepot will hamper ignition and may cause your fire to go out. The firepot should be inspected regularly and cleaned to remove the ash buildup. Again, cleaning the ash from in and around the firepot should be done only when the grill and ashes are COLD.

Remove the grill grates, drip tray, heat baffle, ember shield, and grease drain chute to provide access to the firepot and the interior of the grill. Much of the ash outside of the firepot can be removed from the grill with an ash vacuum cleaner.

⚠ WARNING A dedicated vacuum cleaner is the best way to remove ashes from the firepot, but this must be done with extreme care to avoid the risk of fire. Again, cleaning the ash from in and around the firepot should be done only when the grill and ashes are COLD.

MAINTAINING YOUR GRILL CONTINUED

An ash vacuum cleaner having a metal collection canister without a bag would be best for this task. However, almost any vacuum cleaner will work safely if this procedure is properly followed.

After ensuring that the ash in the firepot is COLD, vacuum the ash from the inside of the firepot.

- a. If your vacuum cleaner is a bagless model, empty any previously accumulated debris from the collection chamber. Then vacuum the ash from the inside of the firepot. Once the firepot is clean, empty the collection chamber into the metal container, handled in the manner described below under Disposal of Ashes, without delay. Make sure that there is no remaining ash residue left in the collection chamber.
- b. If your vacuum cleaner is a model that uses a disposable bag, install an unused bag in the machine. Then vacuum the ash from the inside of the firepot. Once the firepot is clean, remove the bag from the vacuum cleaner and place it in a metal container, handled in the manner described under Disposal of Ashes below.

10. DISPOSAL OF ASHES:

⚠ WARNING Ashes should always be completely cool before handling. Ashes should be placed in a metal container with a tight-fitting lid. The closed container of ashes should be placed on a noncombustible floor or on the ground, well away from all combustible materials, pending final disposal. Ashes should be retained in the closed container until they are disposed of.

11. CLEANING THE GRILL GRATES:

⚠ WARNING Cleaning the grill grates works best while they are still warm. **Be careful not to burn yourself. Always wear heat-protective gloves when cleaning.** We recommend keeping a scraper near the grill. After removing your food, give the grill grate

a quick brushing. It takes only a minute and it will be ready the next time you want to use the grill.

12. CLEANING OUTSIDE SURFACES:

⚠ WARNING Press the main power switch to OFF (0) and disconnect the power cord before initiating cleaning.

Use a disposable rag or cloth dampened with Traeger® Grill Cleaner or warm, soapy water to wipe the grease from the outside of the grill. **DO NOT** use oven cleaner, abrasive cleansers, or abrasive cleaning pads on the outside grill surfaces.

13. TESTING THE GRILL AFTER CLEANING:

Before replacing the grease drain chute, ember shield, heat baffle, drip tray, and the grill grates, plug the power cord into a properly grounded/earthed electrical outlet protected by a Ground Fault Circuit Interrupter (GFCI) and press the main power switch to ON (I). Set the temperature and tap the ignite/shutdown button. Pellets should fall into the firepot and the hot rod should begin to heat (it will start to turn red).

⚠ WARNING Do not touch the hot rod.

When flames start to come out of the firepot, run the shutdown cycle. Let the grill cool down. Now you're ready to place the grease drain chute, ember shield, heat baffle, drip tray, grill grates, and food back onto the grill.

14. POWER CORD

If the power supply cord is damaged, it must be replaced by a special cord assembly available from Traeger.

FREQUENTLY ASKED QUESTIONS

Scan this QR code to take you to Frequently Asked Questions.

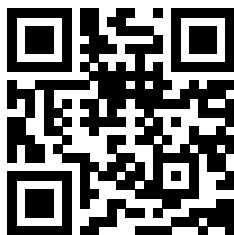

TROUBLESHOOTING

ERROR MESSAGES

Although rare, you may see an error or warning message display on your control panel. Scan the QR code to go to traeger.com/support for a list of error messages and how to resolve them.

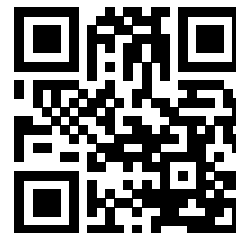

OPERATING TIPS

1. We are always working to improve your grill's performance. Make sure your grill is connected and has the latest firmware update. For instructions on checking your firmware version, go to traeger.com.
2. You can change the temperature at any time during grilling to increase or decrease cooking temperature. However, temperatures should not be changed frequently; doing so will cause them to vary. It is best practice to give the grill some time to reach the desired temperature before making additional temperature changes.
3. To change between Fahrenheit and Celsius: Tap the menu button. Scroll with the selection dial to the F/C icon. Press the dial to select. Then select F or C with the selection dial, and press the dial to confirm.
4. Your Traeger® Grill is designed to operate with the lid closed at all times. Opening the grill lid greatly lengthens your cooking time and will cause the temperature to drop. Do not open the lid before the grill has reached the set temperature.
5. Do not overload the cooking surface with excessive amounts of food that reach beyond the edges of the footprint of the drip tray. This can lead to interference with proper cooking airflow and may lengthen the time to reach the set temperature, causing the grill to not work properly.
6. Cook to temperature, not to time.
7. Always take into account the type of food you are cooking:
 - Generally, thin foods need high heat and shorter cook times, while thicker foods need low heat and longer cook times.
 - Vegetables take longer to cook than meats at the same cooking temperatures.
 - Always check that the internal temperature of the meat that you are cooking reaches a safe temperature for eating.
 - Putting frozen, raw, cold, or otherwise uncooked food on the grill may result in a temporary drop of your grill's internal temperature.
8. Keep the grill clean. Regularly inspect your grill for accumulated grease. Grease fires are caused by not properly maintaining the grill and failing to clean the Traeger® Grease Management System (TGMS) on a consistent basis (see "Maintaining Your Grill" on pages 34-36). Even if there is ample room in the grill, be cautious of loading excessive amounts of food that can release large quantities of grease (for example, more than a pound of bacon). If the grill has not been well maintained or if your previous cooks have produced large quantities of grease, you **MUST** clean the grease from the grill before using it again.

SERVICE



TRAERGER'S LEGENDARY CUSTOMER SERVICE is the best out there. If you have any questions about your Traeger® Grill or need tips on cooking your first holiday turkey, our seasoned experts have your back. We're here for you 365 days a year, including holidays. For assistance with assembly, installation, safe operation, parts, or general customer service, you can reach us at:

TRAERGER'S CUSTOMER SERVICE

Phone: US/CA: 1-800-TRAERGER 6:00 a.m.–10:00 p.m. MT

Website: support.traeger.com

Address: TRAERGER PELLETT GRILLS LLC

533 South 400 West
Salt Lake City, UT 84101

TRAEGER® GRILL WARRANTY



10-YEAR LIMITED WARRANTY

Traeger Pellet Grills LLC warrants this Traeger® Grill for the components, coverage, and warranty period listed in the table below under normal use and proper maintenance. This warranty gives you specific legal rights, and you may also have other rights which may vary among states and provinces. The warranty period starts from the date of original purchase from [traeger.com](https://www.traeger.com) or a Traeger authorized dealer. A list of Traeger authorized dealers is available at <https://www.traeger.com/dealers> (together each an “Authorized Seller”). The warranty period and coverage for the replacement parts shall be as follows:

Warranty Periods and Coverage		
Components	Warranty Period	Coverage
Body, Legs, and Hopper Cover	10 Years	Will not rust through
Controller, Auger Motor, Auger, and Fan	3 Years	Material and Manufacturing Defects
Drip Tray, Ember Shield, and Heat Baffle	3 Years	Material and Manufacturing Defects
Enameled Grill Grates	3 Years	Will not rust through
Hot Rod, Cord, RTD, and Thermocouple	1 Year	Material and Manufacturing Defects
Meat Probe and Wireless Meat Probes	1 Year	Will not rust through

Traeger's entire liability and your exclusive remedy shall be replacement of the defective parts of your Traeger® Grill, if any. Original part(s) approved for return by Traeger's Customer Service must be returned prepaid. Traeger may replace defective parts with new or refurbished parts, at Traeger's sole discretion on an as available basis within ninety days. Without limiting the exclusions stated above, there is not warranty coverage for: (i) paint damage caused by grease fires, (ii) UV exposure, (iii) normal wear and tear; and (iv) warping of the drip tray, ember shield, or heat baffle.

Traeger grills are designed to be modular for simple repair by regular users. Traeger's entire obligation under this warranty shall be to provide you with replacement of any defective parts and to provide you with instructions on how to make the replacement yourself. Traeger may replace defective parts with new or refurbished parts. Traeger reserves the right to inspect any grill (shipping paid by Traeger) and to analyze any usage information including, without limitation, any digital connected grill data (to the extent covered by our data protection policy). To validate and process a warranty claim Traeger may require that you provide reasonable evidence of your issue, including participating in video chats, phone conversations, providing photos, and providing other relevant information. Labor charges connected with the replacement of defective parts and freight charges to ship parts shall be paid at your expense.

The limitations in the following paragraph do not apply to residents of Quebec to whom the Quebec Consumer Protection Act applies.

FOR GREATER CERTAINTY AND TO FULLEST EXTENT PERMITTED BY LAW, TRAEGER PELLETT GRILLS LLC SHALL NOT BE LIABLE UNDER THIS OR ANY IMPLIED WARRANTY FOR INCIDENTAL, CONSEQUENTIAL DAMAGES, INDIRECT, SPECIAL, LOSS OF DATA, EXEMPLARY, PUNITIVE OR ENHANCED DAMAGES, LOST PROFITS OR REVENUES OR DIMINUTION IN VALUE ARISING OUT OF OR RELATING TO YOUR USE OF YOUR GRILL, REGARDLESS OF (A) WHETHER SUCH DAMAGES WERE FORESEEABLE, (B) WHETHER OR NOT TRAEGER WAS ADVISED OF THE POSSIBILITY OF SUCH DAMAGES AND (C) THE LEGAL OR EQUITABLE THEORY (CONTRACT, TORT, OR OTHERWISE) UPON WHICH THE CLAIM IS BASED, AND NOTWITHSTANDING THE FAILURE OF ANY AGREED OR OTHER REMEDY OF ITS ESSENTIAL PURPOSE. THIS WARRANTY GIVES THE RETAIL CUSTOMER SPECIFIC LEGAL RIGHTS AND THE CUSTOMER MAY HAVE OTHER RIGHTS WHICH VARY AMONG STATES AND PROVINCES. BOTH YOU AND TRAEGER INTEND FOR THIS WARRANTY TO BE YOUR EXCLUSIVE REMEDY FOR A DEFECTIVE GRILL.

This warranty shall be void if: (i) the grill is not assembled or operated in accordance with Traeger's operating instructions provided with this grill; (ii) the grill is not purchased from an Authorized Seller; (iii) the grill is resold or traded to another owner; (iv) there has been use of any third party components, parts, or accessories; (v) fuels other than wood pellets designed for wood pellet grills and barbeques have been used with the grill; (vi) wood stove heating pellets are used in the grill; (vii) the grill has been used in a commercial or food service application; (viii) the user has allowed the grill to become damaged, abused, or otherwise failed to maintain the grill in accordance with Traeger's operating instructions; or (ix) there has been any unapproved modification of this grill.

Please note that because Traeger is unable to oversee or control the quality of its products sold by unauthorized sellers, Traeger's warranty is only available if you purchased your grill from an Authorized Seller. Traeger's warranty extends only to products purchased from an Authorized Seller.

To process a warranty claim, contact Traeger's customer service at the phone number or address listed above. Traeger requires proof of your date of purchase from an Authorized Seller. You should retain your sales slip or invoice along with this manual with your valuable documents.

Customers outside of the United States and Canada should note that NOT all warranty policies stated herein are consistent globally. Customers should contact the local distributor in their current country from the list at International Support for instructions regarding warranty claims specific to that country. The process described herein will not work for international warranty requests.

ADDITIONAL IMPORTANT WARRANTY INFORMATION

- We are not responsible for items lost in transit. For this reason, we highly recommend getting a tracking number or delivery confirmation when shipping your package.
- The product you send to us becomes the possession of Traeger and will not be returned to you.

Traeger will determine if your warranty claim is covered under this warranty policy at Traeger's sole and complete discretion, and failure to follow the required procedures may void your warranty claim. This warranty gives you specific legal rights, and you may also have other rights which vary among states, provinces, and countries.





WELCOME
TO THE
TRAERGERHOOD

FOLLOW US @TRAERGERGRILLS



Traeger Pellet Grills LLC
533 South 400 West
Salt Lake City, UT 84101

traeger.com

© 2024 Traeger Pellet Grills LLC. All Rights Reserved.
The Bluetooth® word mark and logos are registered
trademarks owned by Bluetooth SIG, Inc. and any use
of such marks by Traeger is under license.
Other trademarks and trade names are those of their
respective owners.

Patent: www.traeger.com/patents