

ALFA



NORTH AMERICA ONLY



USER MANUAL
domestic ovens

Write in this section the data of your product.



Oven Model:

Serial number:

Purchase date:



NB: The identification label is located on the back of the product.

Visit www.alfaovens.com and register your oven today.

1

Identifies the serial number, the identification label is located on the back of the product.

2

Visit our web site and click on "register your product" or type "alfaorni.com/registration.php"

3

Enter your information and register

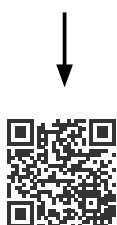

02	GENERAL WARNINGS
04	SAFETY WARNINGS
06	POSITIONING THE OVEN
08	LPG / NG CONNECTION WARNINGS
09	LPG / NG CONNECTION AND INSTALLATION
13	LPG / NG CONVERSION INSTRUCTIONS
16	LIGHTING THE OVEN - WOOD
20	LIGHTING THE OVEN - GAS
22	USING THE OVEN
26	COOKING & DOUGH RECIPES
32	MAINTENANCE AND CARE
38	BASIC VENTING GUIDE
42	TROUBLESHOOTING
44	WARRANTY

GENERAL WARNINGS

RETAIN THIS MANUAL FOR FUTURE REFERENCE
Additional copies of this manual at www.alfaovens.com

WARNING: improper installation, adjustment, alteration, service or maintenance can cause property damage, injury or death. Read the installation, operating and maintenance instructions thoroughly before installing or servicing this equipment.



Never touch the metal door or flue during use as they are not insulated and become very hot when in use.



THIS USER MANUAL IS VALID IN NORTH AMERICA ONLY.

PLEASE READ THE FOLLOWING INFORMATION FOR PROPER INSTALLATION AND OPTIMUM PERFORMANCE OF THE OVEN.

- The identification plate, with technical data, lot number and brand name is visibly applied on the device. Do not remove this label
- Remove all protective film before putting the unit into operation. To help facilitate the separation, use warm air (for example, a hair dryer)
- Never use steel sponges or sharp scrapers, it can damage the stainless surfaces. Use ordinary non-abrasive products. If necessary, use wood or plastic tools. Rinse thoroughly and dry with a soft cloth or microfiber cloth.
- Do not use dishes or containers made of plastic material. The high temperatures inside the oven could melt the plastic, damaging the appliance.
- Use tools and utensils that are resistant to high temperatures.
- Position the oven on a flat and level surface.
- Due to the temperature, the color of the surfaces may vary in time.
- Installation of the product must allow for easy
 - access for cleaning and access to and remove burner on gas models.
- Never store, use or put flammable liquids or objects in or near the oven.
- ALFA stainless steel ready-to-use ovens can become hot on the outside even with two layers of high quality insulation.
- Always remove the oven door by gripping the handles and using gloves when hot.
- Closing the door when the oven is lit with flame can cause the flame to go out from lack of oxygen
- Do not touch the surfaces of the chimney flue during use.
- Keep any electrical wiring and fuel lines away from hot surfaces.
- Do not use the oven if it's not working properly or you suspect a fault in operation.
- Do not move the oven during use or when it is hot.
- Do not lean on or rest objects on the oven, this may compromise its stability.
- Never extinguish the flame with water.
- In the event that a grease fire occurs, turn off the gas and leave the door closed until the fire is extinguished.
- When using the oven wear heat resistant oven gloves.
- The parts that are sealed by the manufacturer should not be modified by the user.
- Do not block the openings and slots provided for ventilation and heat dissipation.
- When using charcoal, only use high quality natural lump wood charcoal. Do not use briquettes, lava rock, liquid fuels, accelerants or anything other than that expressly indicated.
- Do not lift the oven from the sill or shelf



SAFETY WARNINGS

FOR WOOD-BURNING OVENS ONLY

READ ALL INSTRUCTIONS BEFORE INSTALLING AND USING THIS APPLIANCE
Do not install where prohibited.

FOR YOUR SAFETY: Do not store or use gasoline or other flammable vapors or liquids in the vicinity of this or any other appliance. Also, always keep the area under and around this appliance free and clear of any and all combustible materials

WARNING: Improper installation, adjustment, alteration, service or maintenance can cause property damage, injury or death.

WARNING: Do not use wood fired ovens in any enclosed room unless properly vented and meeting all local building codes and approvals.

SAFETY WARNINGS

FOR GAS-BURNING OVENS ONLY

GAS LEAKS MAY RESULT IN FIRE OR EXPLOSION AND CAUSE SERIOUS PERSONAL INJURY OR DEATH, OR PROPERTY DAMAGE.

IF YOU SMELL GAS:

1. Turn the gas off.
2. Put out any live fire or flames.
3. Open the door to the oven.
4. Consult a licensed gas professional

ATTENTION! The gas oven may be converted from LPG to natural gas and viceversa using the Alfa Ovens supplied conversion kit. Follow the supplied instructions or contact a qualified and licensed gas professional.

WARNING: If the gas oven is not used
close the gas supply valve.

WARNING: Do not store unused gas cylinders near the oven.

POSITIONING THE OVEN

ATTENTION

THE OUTER WALLS OF OVEN MAY REACH HIGH TEMPERATURES GREATER THAN 50°C / 120°F. ANY FLAMMABLE MATERIAL SHOULD BE KEPT AT LEAST 3 FEET (1 METRE) AWAY FROM THE OVEN.

CAUTION: When being used, place the oven at a safe distance from flammable materials or substances that may be damaged by heat

CAUTION

Place the oven on a flat, stable surface to prevent it from moving during use.

CAUTION! Position the oven at a minimum distance of 8 in (20 cm) from the walls and from any other equipment.

COUNTER TOP OVENS SHOULD BE PLACED ON FIXED TABLES OR TABLES WITH LOCKING WHEELS OR OTHER FIREPROOF SURFACES WITH ADEQUATE LOAD-BEARING CAPACITY. IF NEEDED, ADJUST THE LEGS TO LEVEL THE SUPPORTING SURFACE.

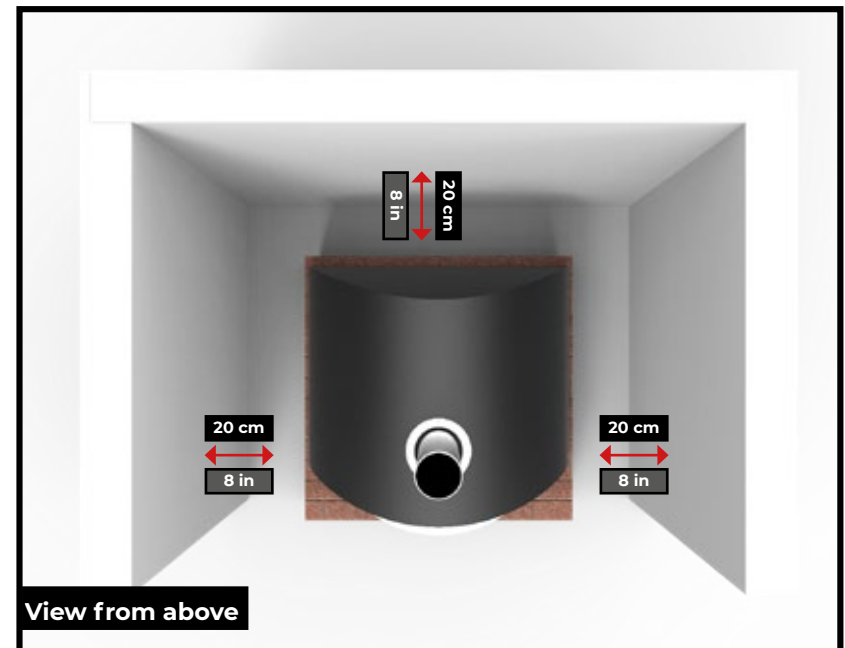
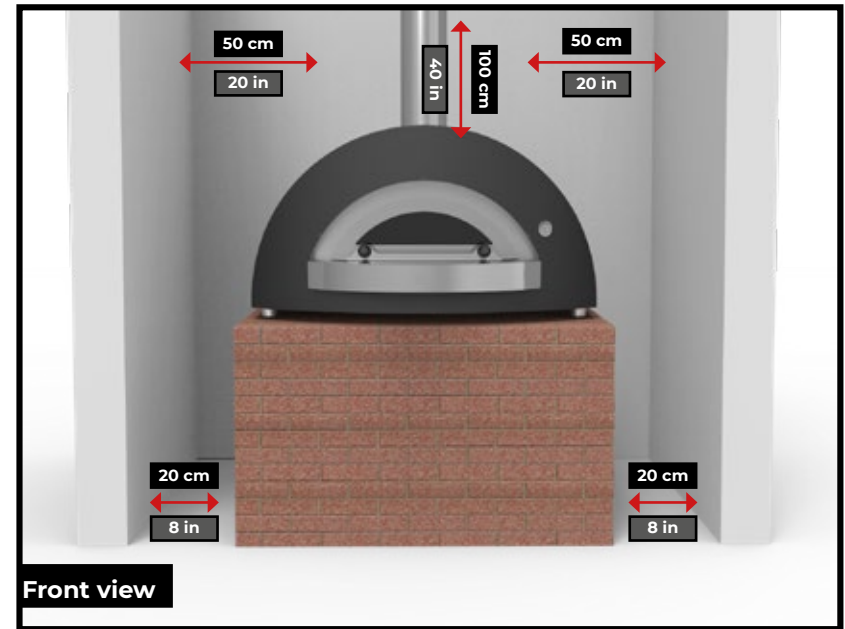

LPG/NG CONNECTION WARNINGS

ONLY FOR LPG OVENS

Use the supplied conversion kits if changing from factory settings

- LPG is heavier than air. Any losses of LPG may collect in a lower part of the environment.
- The LPG cylinder must always be installed, transported and stored in a vertical position. Handle with care and do not drop the LPG cylinders.
- Make sure the gas tank is placed in a ventilated place that it is away from other objects.
- Never store a spare gas cylinder near the gas oven.
- Do not leave or transport the LPG cylinders in places where temperatures can reach 120°F/50°C (too hot to handle. For example: Do not leave the cylinder in the car on hot days).
- Treat "empty" LPG cylinders with the same attention as full ones. Even if there is no more liquid in the cylinder there may always be gas fumes.
- Always close cylinder valve before disconnect in gas there could still be pressure
- Always check all gas connections before using the oven.
- Make sure to use the proper PTFE gas piping tape for all threaded connections.
- It is recommended that all gas connections are checked before using the oven.
- Make sure that the valve on the LPG cylinder or the regulator is closed. Replacement of the cylinder must be performed away from sources of heat and ignition.
- Only use cylinders rated for LPG.
- Do not twist the hose.
- Before each use check that the hose does not have any marks, cracks, abrasions or cuts. If the hose is damaged in some way, do not use the oven.

LPG/NG CONNECTIONS

CONNECT THE LPG CYLINDER (only for LPG oven)

Connect the flexible hose to the back of the oven.

PRESSURE REGULATOR :

Liquid Propane Gas (LPG):
11.0" Max water column pressure (W.L.P.)

Natural Gas (NG):
4.0" Max water column pressure (W.L.P)

FLEXIBLE HOSE:

Diameter 1/2"

CYLINDER

Recommended Type 1 20lb, 30lb, or larger

Pressure regulator, flexible hose and cylinder are not supplied with the oven.



NATURAL GAS SUPPLY

– Connect the flexible hose to the back of the oven.

– The natural gas supply must be delivered through a galvanized pipe Ø 1/2" or equivalent copper pipe, located at the burner inlet hole.

– Install the gas shut-off valve in a suitable position up-line.

ATTENTION!

Follow our advice to correctly use your oven.

– We recommend checking gas connection before using the oven.

– Make sure the gas tap is turned off when the oven is not being used and during maintenance or cleaning operations.

– Before using the oven, check out the hose searching for cracks, cuts or any wearing sign. If the hose is damaged, do not use the oven.



LPG/NG CONNECTION AND INSTALLATION

SEE BELOW TO FIND YOUR OVEN AND HOW IT IS CONFIGURED FROM THE FACTORY

ALFA ONE and BRIO GAS OVENS COME FROM FACTORY PRE-SET FOR LPG (NG CONVERSION KITS INCLUDED WITH OVEN)

ALFA STONE M and STONE L COME FROM FACTORY PRE-SET FOR NG (LPG CONVERSION KITS INCLUDED WITH OVEN)

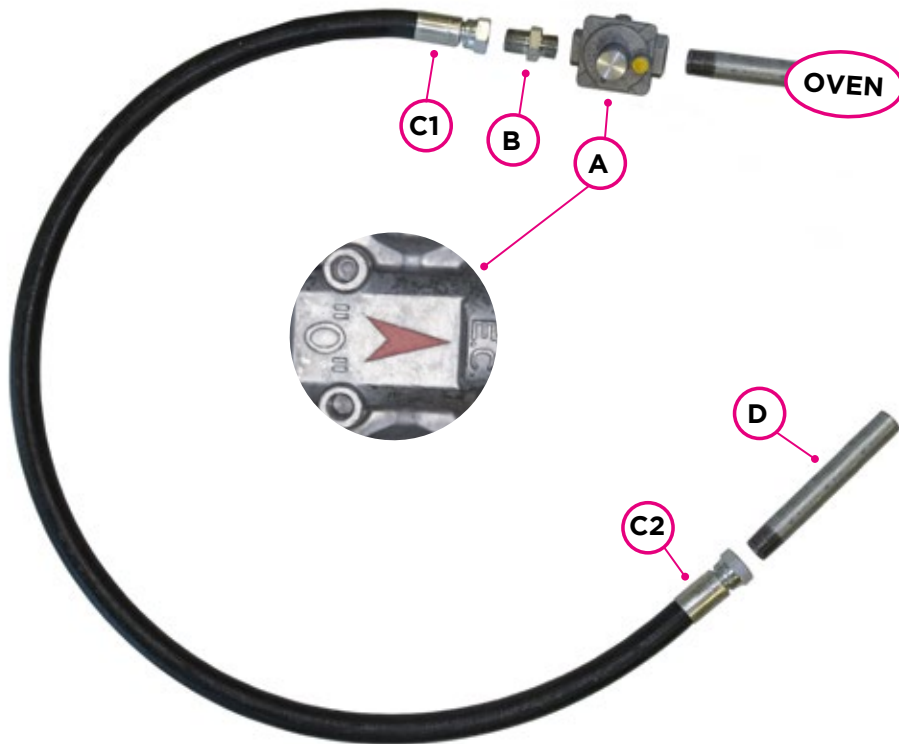

NG CONNECTION

- A** REGULATOR CONNECT TO OVEN *(supplied)*
- B** BSPP - NPT ADAPTER *(supplied)*
- C1** GAS HOSE TO OVEN
- C2** GAS HOSE TO GAS SUPPLY
- D** GAS SUPPLY PIPING

continue next page >>

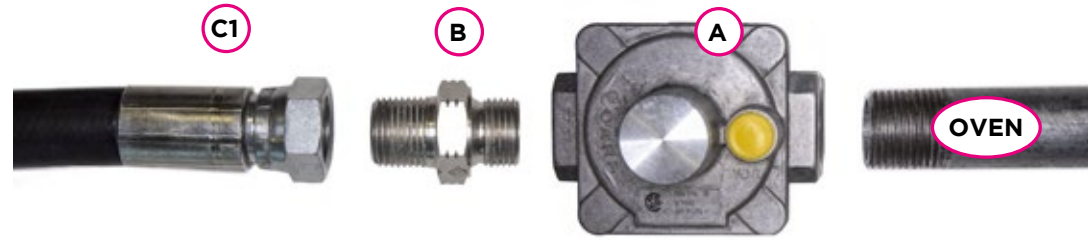

Mount the adapter (B) on the gas inlet (C1), followed by the regulator (A).



Connect the gas supply (D) to the gas hose (C2)

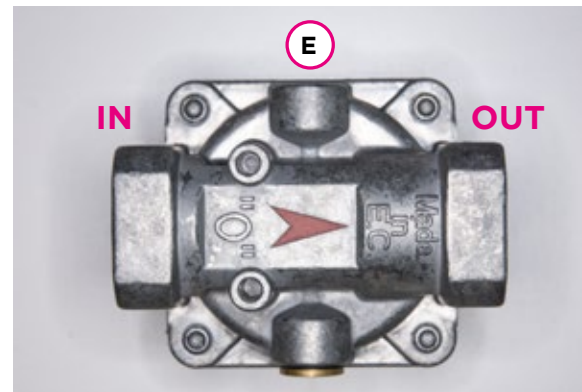

CAUTION

Respect the direction indicated by the arrow to connect the regulator.

CONNECTION TO THE GAS CYLINDER



LPG CONNECTION

- A** REGULATOR CONNECT TO OVEN *(supplied)*
- E** 1/2" MALE GAS FITTING (3/8" OD FLARE X 1/2" MIP - TAPPED 3/8" FIP) *(supplied)*
- F1** LPG HOSE CONNECT TO OVEN *(supplied)*
- F2** LPG HOSE/REGULATOR CONNECT TO PROPANE GAS CYLINDER. *(supplied)*

- Connect Regulator (A) to the oven.
- Connect Propane Hose (F1) to the Regulator (A) using 1/2" Male Gas Fitting (E) - 3/8" OD Flare x 1/2" MIP - Tapped 3/8" FIP.
- Connect Propane Hose/Regulator to Propane Gas Cylinder

*Use PTFE tape or pipe thread sealant where needed

LPG / NG REGULATOR CONVERSION INSTRUCTIONS

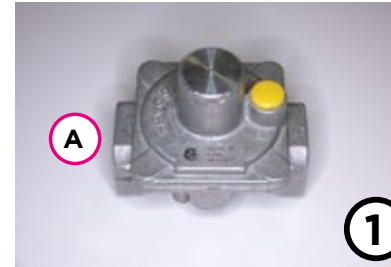

1 - Begin by Converting the Regulator to LPG

NATURAL GAS SUPPLY (H)



2 - UN SCREW THE CAP TO ACCESS THE REGULATOR ADJUSTMENT.



3 - THE PLASTIC ADAPTER SHOULD BE TURNED UPSIDE DOWN DEPENDING ON THE TYPE OF GAS SUPPLY.



4 - CONVERTING THE REGULATOR

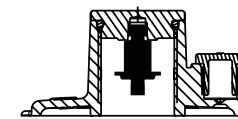

LPG SET UP

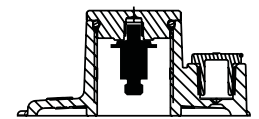

NATURAL GAS SET UP



5 - REFIT THE CAP.

GAS ORIFICE AND PILOT SPUD CONVERSION

NATURAL GAS (NG) – LIQUID PROPANE GAS (LPG)

ONLY USE THE COMPONENTS AND PARTS SUPPLIED WITH THE CONVERSION KIT

WARNING: The following conversion should be performed by authorized professionals when the oven is completely cold. Improper installation, adjustment, alteration can cause property damage or injury.

See next page for proper spud and orifice component numbers

1 - GAS KIT DISASSEMBLY

Remove the gas kit according to the instructions in the appropriate section of the manual.

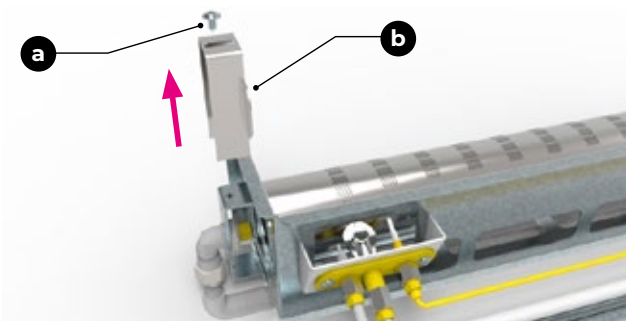

2 REPLACEMENT OF THE MAIN GAS NOZZLE

Unscrew the fixing screw (a) and remove the plate (b) covering the nozzle. Unfasten the main nozzle (e) to the holder screw (d) by using an 11 mm spanner. Replace the nozzle with orifice supplied in the kit and screw it back to the holder (d). During these operations, secure lock the nozzle holder (d) to keep it from rotating.

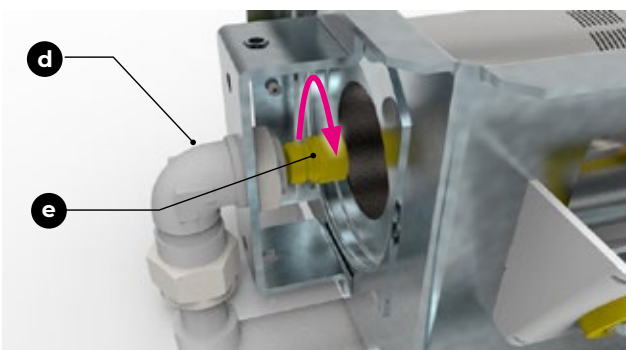

3.1 REPLACEMENT OF THE PILOT SPUD

Unscrew the fixing screw (h) of the pilot light tube..

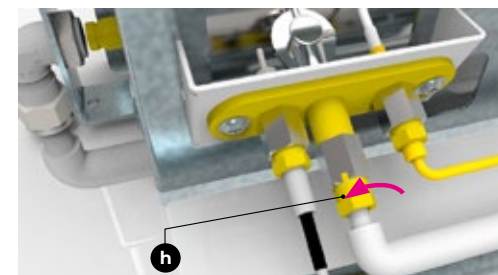

3.2

Remove the tube (i) from the seat.

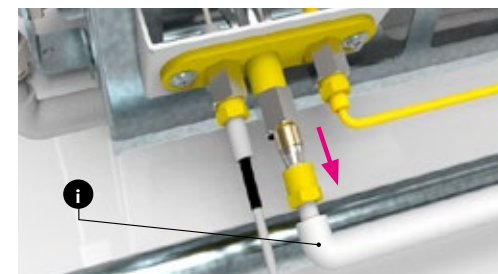

3.3

Remove the pilot nozzle (j) from the cone-like support (o) and replace it with the spare component supplied in the kit.

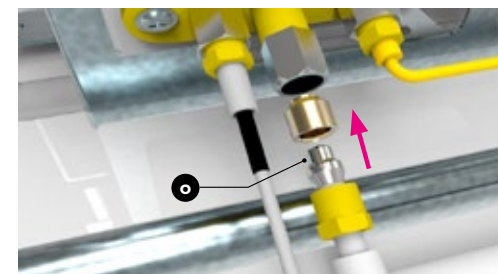

Reassemble everything following the same steps in reverse order.

Following the conversion, apply the new label on the product and check that the size of the nozzle corresponds to that shown on the label.

LIGHTING THE OVEN

ONLY FOR WOOD VERSION

WARNING: Follow the instructions before turning on the oven.

- Do not use flammable liquids or other fuels to light the oven.
- Make sure that there are no flammable materials near the oven and that the minimum safety distance is respected.

1 - In the center of the oven or slightly right of center create a cross stacked pile of ALFA Wood using smaller pieces. Include 2-3 QwikWik brand or your favorite fire-starters to help start the fire quickly.

2 - Light the QwikWik firestarters to ignite your initial cross stacked wood pile in the oven

3 - After the wood is on fire, replace the oven door on the oven warming shelf leaving a small gap of 1-2 inches so air can enter the oven and to help keep the fire roaring. This helps keep the fire in the oven and heat the oven to your desired temperature faster.

4 - Slowly add larger wood logs to create a larger fire. Do this for about 15-20 minutes depending on the size of your oven. Larger ovens can take longer to heat up. Do not put too much wood in at one time and replace the door as noted in section 3 to help keep the flame inside the oven.

5 - After you've built a nice fire and hot bed of coals move them to the left side of the oven with the help of the ember mover. The fire should be on the opposite side of the thermometer for the most accurate oven chamber temp.

6 - Clean the refractory floor with the brush tool.

7 - Using a laser thermometer check the temperature of the oven floor. You want it to be about 650°-750°F.

8 - When the oven floor is the right temperature you're ready to begin cooking your pizzas! Cook pizzas with the oven door off and feel free to replace the oven door with the same gap for air as mentioned in section 3 to keep heat and flame in the oven.



TURNING OFF

- To turn the oven off, close the oven door and wait for ash to form.
- When the fire is out and the oven has been completely shut down for 60 minutes or longer and you confirm the coals have cooled down, you can remove the ashes into a fire safe metal ash can.
- Never put hot coals or ashes on the ground, patio, deck or near plants or trees.

DIFFERENT TYPES OF WOOD

- Use small sized wood pieces that are very dry for lighting.
- Treated wood, pine, resin or scrap woods are strictly prohibited.
- Wet or damp wood can be difficult to start and can pop due to the increased volume of water. This will produce a lot of smoke and ash and less than optimal heat and performance.

FOR YOUR SAFETY:

- Do not exceed the temperature limit of 1000°F / 500°C.
- Do not leave the oven unattended when the fire is going.
- To keep constant temp, throw in small quantities of firewood at regular intervals; do not keep adding more logs to avoid a dangerous rise in temperature or flames spilling out of the oven that might damage people or property.

LIGHTING THE OVEN

ONLY FOR GAS VERSION

WARNING: Follow the instructions before turning on the oven.

- Check all gas connections for gas leak before starting your oven.
- Use the proper PTFE gas piping tape for all threaded connections
- Do not lean over the oven when lighting. Keep your face and body at a safe distance from the oven door.
- When lighting the oven, the oven door must be open.
- The burner control knob must be in the off position before turning on the LGP cylinder valve.
- Do not move the oven while it is in use.

1 - Connect to 20lb. tank using supplied dual regulator hose or direct connect to natural gas source. Make sure the burner stabilizer is connected in the correct direction to the burner at the oven.

2 - Push IN the burner knob and turn it counter-clockwise to the star symbol on the control panel.

3 - While KEEPING the burner knob pushed in, push the ignitor button at the same time to light the burner pilot flame.

NOTE: Lighting the pilot flame for the first time or after it has cooled could take some time and possibly a few attempts due to air in the supply line. Be patient as the gas makes its way to the pilot light.

4 - Once the pilot flame is lit properly you will see a small flame inside (rear left corner) of the oven. You can now release the ignition button BUT will need to KEEP the burner knob pushed in for 15 seconds. This will ensure that the thermocouple is hot enough to allow the pilot flame to stay on.

5 - Slowly release the burner knob and turn it counter- clockwise to the larger dual flame symbol on the control panel.

The oven burner is now on high and you can start preheating the oven.

6 - Return oven door to warming shelf leaving 1-2" gap all the way around the oven opening so air can enter the oven. Do not close oven door tightly or the lack of air will force the flame to extinguish. Preheat oven for 45 minutes to allow the fire bricks to get to pizza making temp. Using a laser thermometer, check the oven floor temperature. You want the floor to be 600°-700°F to make pizza.

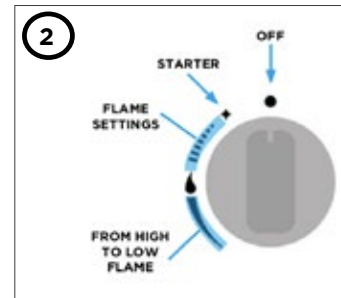

FOR YOUR SAFETY:

- Do not close the door when the oven is lit with the flame at the maximum position.
- Do not exceed the temperature limit of 1000°F / 500°C.
- Never disconnect the gas pipe or other fittings when using the oven.

LIGHTING THE OVEN

- 1.1 For Neapolitan pizza

Pizza needs both flame and very hot sustained temperature (floor and dome). Use small dry pieces of wood to start your fire and control your flame and temperature:



- 1.2 For grilling

Grilling uses more embers to get the smoke flavor in the oven and less flame to prevent burning. Larger pieces of wood or lump charcoal (not briquettes) can help control temps.

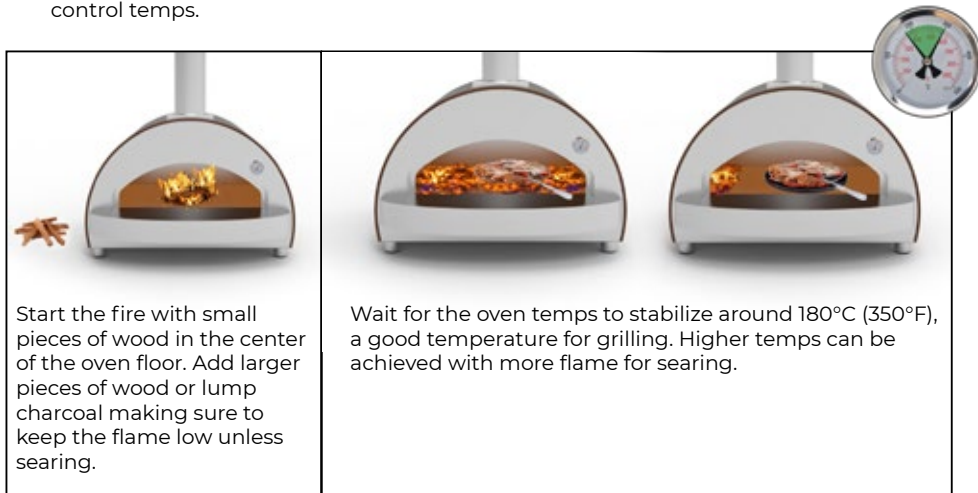

1.3 For baking / tray

The stainless steel ovens are made to light up and increase temperature in a short time and hold temps for extended periods of time.

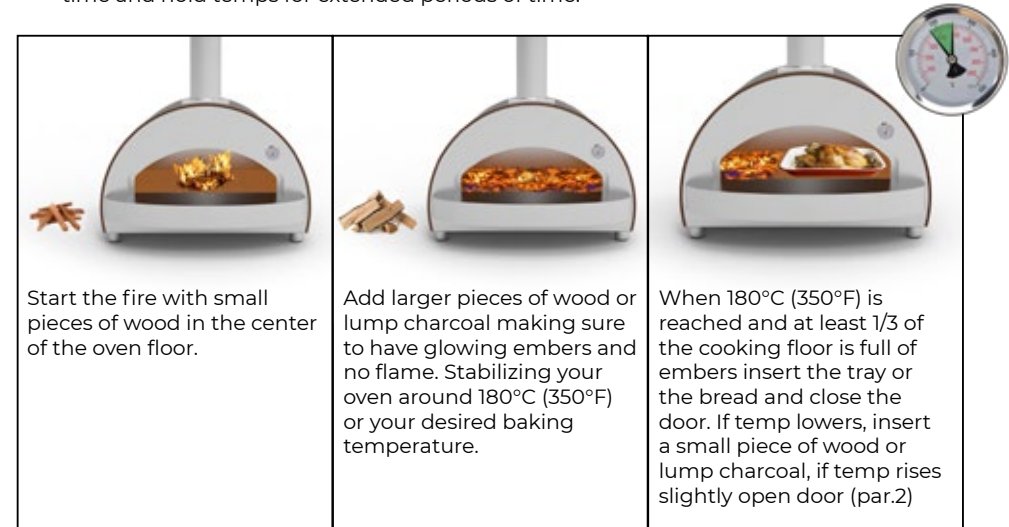

SMOKE

- 2.1 Manage the smoke

Smoke can be desired for traditional barbecue but also can be too much for certain foods and for the people that you are entertaining both taste wise and vision/smell wise

1. Use dry wood (wet wood doesn't burn well and makes smoke)
2. Try to keep the flame always on
3. If you have embers (no flame) insert a small piece of paper or starters and then put a small piece of wood, paying attention to let the air enter among embers and wood
4. To avoid the smoke do not use the door - more air enters, less smoke you'll have
5. Place the oven strategically so smoke is manipulated to flow away from your entertaining area the wind can affect smoke as well especially on an abnormally breezy day

- 2.2 Looking for the smoke



For the people who want to cook with smoke we suggest to:

1. Try to close the door when the flame is on
2. Use big pieces of wood or lump charcoal
3. If the flame is high break the flame to produce embers (and then use the door or big pieces of wood)
4. Incorporate a smoker box filled with soaked wood chips of desired flavor

USE THE DOOR AND SMALL PIECES OF WOOD TO STABILIZE



- 3.1 Stabilize the temperature

The wood fired oven is designed to let the user choose the right temperature depending on what they are cooking. Stabilizing the temperature is the biggest challenge for the user but with experience it becomes much easier. There are 3 elements designed to assist in Temperature stabilization:

 <p>The Door (use the door to control the internal temperature, open more to cool down and close more to raise it up). Completely Close to smother the fire</p>	 <p>The Fuel: Small pieces of wood or lump charcoal (once temperature is consistent and stable, add small pieces of lump coal or wood chunks to maintain the desired temperature and to avoid either temperatures that are too low or creating sudden jolts of high temperatures or flames)</p>	 <p>Rotation -Control and check distance of food from the flame and embers to prevent burning your meal (closest to flame/embers is the highest temperature) Rotation is a key technique</p>
--	--	---



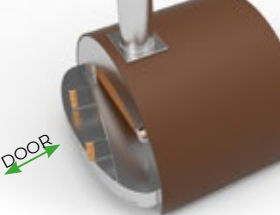

- 3.2 Cool down the oven

The wood fired oven is a machine that can easily reach temps over 500°C (1000°F) but with no possibility to switch off (never use the water as it can cause the oven floor fire bricks to be damaged). We suggest doing these 3 actions:

 <p>Open the oven door gradually keeping the flame exiting through the chimney flue, the more you can open the more the oven can cool down.</p>	 <p>Use the pizza turner or wood rake to break the fire and wood.</p>	 <p>Spread the embers over the cooking floor.</p>
--	--	--

- 3.3 Raise the temperature up

The wood fired oven is a machine that can also raise the temperature quickly, with stainless steel dome oven, it's simply and easy to do.

 <p>FROM 150°C (300°F) TO 250°C (480°F) Insert 1 small piece of wood and close the door partially on the opposite side of the flame</p>	 <p>FROM 200°C (400°F) TO 300°C (570°F) Insert 2-3 small pieces of wood and leave the door open to let the air enter</p>
 <p>FROM 200°C (400°F) TO 400°C (750°F) Insert 3-5 small pieces of wood and leave the door open to let the air enter</p>	 <p>RAISE 50°C (100°F) Close the door and check the temperature</p>

FLAME INTENSITY, COOKING FLOOR AND TEMPERATURE



- 4.1 Flame and cooking floor for Neapolitan pizza

The flame for the Neapolitan Pizza has to be strong. Use laser thermometer to measure the temperature of the oven floor. The ambient and oven floor temps should both be about 700°F. The flame should go across the top of the dome ceiling in the oven.



- 4.2 Flame for roman and focaccia pizza

The focaccia (also called roman pizza) needs lower temperature than Neapolitan pizza. Reaching lower temperatures of around 500°F is easy: you need a small flame that reaches the highest point of the dome.



- 4.3 Deep Dish Pizza/Detroit Style Pizza

Pizza in a tray/pan is made for more toppings and a thicker pan crust. Cast Iron, stainless steel or mixed-use heavy trays are recommended. The cooking process for this method of pizza making is slower and lower temperature around 350°F, giving the crust and bottom of the pizza time to fully bake. It is recommended to use aluminum foil on top during the cook so the top of the pizza does not burn. It can be removed at the very end when pizza is finished to brown the top.



- 4.4 Small bread (rest of the pizza dough)

It is common to have some leftovers when you make many dough balls. We suggest freezing them. Otherwise, you can give them as a present to your party guests and cook for them before they go. Put a small piece of wood, close the door partially and reach 450°F. Stretch to lengthen the dough, put the oil on top and place it on the cooking floor; after 15 minutes your bread should be ready. Do not cut it till it gets cold (we know the smell will attract you so much).



- 4.5 Big bread (rest of the pizza dough)

If you want to cook a larger loaf of bread (at least 4 pizza dough, 1 Kg) you want to have lot of embers. With temperature approximately 400°F and the cooking floor is around 400°F you can insert the bread dough. We suggest closing the door and checking the temperature every 5-10 minutes. The oven should cool down to 325°F in one hour and the bread should be ready (do not cut it till it's cold).



TIPS TO ORGANIZE A PIZZA PARTY

- 5.1 How many people there are at the party?

You can organize parties from 3 to 100 people, just don't panic and remember some small tips:

1. If less than 10 people you can make a more sophisticated menu (many different kinds of pizza); if more people we suggest being really focused on basic Neapolitan pizza and minimal toppings
2. We usually count 1-2 10" pizzas for each guest (then 250-300 grams of flour each)
3. Always keep in mind your guests: if they have any special requirements or food allergies you need to plan in your menu
4. You can include appetizers to let people eating while waiting and give to the oven maestro enough time to get everything ready

- 5.2 Am I alone or do I have any assistant at the party?

When you organize a pizza party with more than 10 guests, we suggest you to have an assistant to help with your preparations or cooking.

1. Fire up and take care of the oven
2. Cut all the pizza ingredients
3. Set up the table

- 5.3 Weeknights after work?

If you are hosting the party during weekdays with a better need to organize your time. The ALFA oven is ready to cook 30 minutes! We suggest making the pizza dough 1-2 days ahead of the party. You can also make the pizza dough weeks before and freeze the dough balls. Remember to take it out from the freezer 24-48 hours before your event and slow thaw in the fridge. Remove dough immediately when home as its necessary for the pizza dough to acclimate to room temperature, usually 1-2 hours.

- 5.4 Make your party unforgettable! Include your guests in the party — let them make pizza!

During the pizza party people love to be involved, so keep in mind they can be your assistants. Teach your friends, family and guests to enjoy the ALFA Oven just like you do. Cutting finished pizzas, adding fresh toppings and taking care of the oven... but most of all they love to stretch pizzas and make their own special pizza like the oven maestro does. Stretching the pizza will be the funniest game for adults and children, let's try! Cooking pizzas for friends, family and guests is all about the lifestyle and entertaining. Talk, cook, have a drink and most of all HAVE FUN!

YOUR TO-DO LIST FOR A PERFECT PIZZA PARTY (WITH BRUSCHETTA)



Make the pizza dough well in advance before the party*



Prepare the dough balls in room temperature 1 to 2 hours before the party*



Light up the oven 30 minutes before and in the meantime cut the ingredients



Cook some bruschettas (with tomatoes and basil on top) while waiting for the oven to reach the temperature



Start the pizza party, using your imagination to invent original pizzas



Finish the party giving people the leftover dough or cooked pizzas!

*These timings depend on the season and the outside temperature: in Summer can be lower; in Winter you will need to find the hottest room of your house to wait for the pizza dough to raise.

"Cooking with a wood fired oven is to celebrate our roots, where we come from, what we love more, spending time with our families and friends, smelling a wonderful perfume of flour, meat and wood. I think there is no any better emotion we can enjoy in life."

— Rocco Lauro founder

"Everytime friends organize a pizza party I try to stay away from the cooking stage: but the oven attracts me too much. All the parties finish in the same way: me, enjoying that time using the Alfa oven."

— Marcello Ortuso, founder

ALFA SPECIAL RECIPE FOR THE PERFECT PIZZA DOUGH Recipe for 5 medium or 4 big pizzas

INGREDIENTS



Flour: 1 Kg (look for an Italian brand: "5 Stagioni" or "Caputo" are the most famous in the States)



Water: 630 grams or ml (we suggest to use a good mineral water)



Brewer Yeast (not dried): quantity depends on the weather - 1gr and 6h if in Summer, 3gr and 24 hour if in Winter



Salt: 30 gr



Oil: a spoon or more if you like a softer dough; we suggest Italian cold pressed oil.



Honey or malt: a spoon

PREPARATION



You start from putting all the warm water in a bowl. Then you take the oil, the yeast and the honey and you melt them together.



Then you take half flour and you mix it till it gets a cream.



Then you put salt and other 50% of flour and mix till you can see a smooth dough (the secret to make it really smooth is to leave it resting for 5 minutes while you're pulling the dough).



You wait till the dough has raised 2-3 times its original volume (we always choose the coldest place in the house during the Summer; if it's really hot you can put it in the fridge).



Then you cut it with a knife and you make dough balls (around 250-300 grams each).



You wait till they have raised again and then you just have to enjoy! We suggest semolina flour to stretch the dough.



BASIC 24 HOUR PIZZA DOUGH

- Initial fermentation 20 minutes covered room temperature
 - Bulk fermentation 2 hours covered room temperature
 - Divide, shape and cover dough 10 minutes
 - Second fermentation 24 to 48 hours refrigerated
 - Sample Schedule: Mix the dough at 5PM, shape into dough balls at 7PM, cover and refrigerate. Make pizza the next evening (optimal) or the day after that (still very good)
1. Measure and Combine the Ingredients: Using your digital scale, measure 300 grams of 90° to 95°F (32° to 35°C) water into a 6-quart dough bowl. Measure 12 grams of fine Mediterranean Sea Salt, add it to the water, and stir or swish around in the tub until it's dissolved. Measure 1.5 grams of instant dried yeast. Add the yeast to the water, let it rest there for a minute to hydrate, then swish it around until dissolved. Add 500 grams of flour (preferably 50/50 mix of Caputo 00 Pizza and Chefs flour) to the water-salt- yeast mixture.
 2. Mixing the Dough: Mix by hand, first by stirring your hand around inside the dough tub to integrate the flour, water, salt and yeast into a single mass of dough. Continue for just about a minute or two. The target dough temperature at the end of the mix is 80°F (27°C); use your probe thermometer to check it.
 3. Knead and First Rise: Let the dough rest for 20 minutes, then knead it on a work it on a hard surface with a very light dusting of flour for about 2 to 3 minutes. The skin of the dough should be very smooth. Place the large dough ball, seam

side down, in a lightly oiled proofing box or bowl. Cover with a tight fitting lid or plastic wrap. Let the dough rest for 2 hours at room temperature (assuming 70° to 74°F/21° to 23°C) for the initial rise.

4. Shape and Divide into Dough Balls: Moderately flour your work surface about 2 feet wide. With floured hands, gently ease the dough onto the floured work surface. With your hands still floured, pick up the dough and ease it back down onto the work surface in a somewhat even shape. Dust the entire top of the dough with flour, then cut it into 3, 4 or 5 equal-sized pieces, depending on the size of pizzas you want to make, using your scale to get evenly sized dough balls. Shape each piece of dough into a medium-tight round balls.
5. Final Fermentation: Put the dough balls, seam side down back into your lightly oiled proofing box, leaving space between them to allow for expansion. Lightly flour the tops and tightly cover with lid plastic wrap if using separate bowls and put them into the refrigerator. Refrigerate until ready to make pizza, either the next evening (24 hours ideal) or the day after (still good).
6. Time to make the Pizza!: Remove the dough balls from the fridge 2-3- 4 hours before making pizza. This timing all depends on your room temperature. The dough should be at room temperature (about 72°F) when you are ready to cook the pizzas.

SOURDOUGH RECIPE

Use high-protein, unbleached flour (bread flour) — if you want to change to 00 flour then also drop hydration down to 60-62%

· 65%hydration · 25% sourdough starter · 2%salt

1. Mix/dissolve the starter into the (room temp) water
2. Add salt
3. Mix in flour until it forms a shaggy ball, cover with plastic- wrap and allow to rest for 20 minutes.
4. On floured surface, stretch and fold for 2-3 minutes (to develop gluten structure) form a ball and place in a lightly-oiled container and cover with plastic wrap. Allow to rest at room temp for 2 hours and then place in refrigerator for 24-48 hours.
5. On baking day, remove from refrigerator, form into balls, cover and allow to come up to room temp (4-5 hours) and bake your pizzas.

REGULAR MAINTENANCE

1 - PYROLYSIS CLEANING OF THE OVEN CHAMBER AND COOKING FLOOR.

The ALFA oven can be cleaned by the fire itself through a process called “pyrolysis” (pyro “fire” + lysis “separating”). The processes involved in charring wood and it has a function of thermal cleaning, which removes organic substances from products or production components. During the thermal cleaning process, organic material is converted by pyrolysis and oxidation into volatile organic compounds, hydrocarbons and carbonized gas. Inorganic elements remain. To clean the oven with pyrolysis we suggest to keep the temperature above 425°C / 800°F for 5 minutes. You can also spread the hot coals from your cook across the fire brick oven floor. They will burn off any particles or residue that may have been leftover from your cook.



2 - CLEAN THE COOKING FLOOR BEFORE COOKING.

After the oven has completely cooled down (usually next day) you can remove the cold ashes away from the oven. (ALWAYS to use a fire resistant bin to hold the used ashes). When you are 100% certain the ashes are cold you can put them in an ash pan or you can also use the ashes as a fertilizer for your plants/garden. Periodically you can remove the firebricks and vacuum the ashes from the holes of the cooking floor with an outdoor shop vac.



3 - CLEANING THE OUTSIDE OF THE OVEN.

Never use abrasive products on powder coated surfaces. Like all 304 stainless & powder coated products, these are built to withstand and resist many environments including coastal salt marine, however will need regular care and maintenance. Wash with a soft cloth and a solution of soap and water or use a cleaning solution mixture you can easily clean the powder coated parts of the oven.

In addition, you can use a mix of 50/50 Baking Soda and Dish Washing liquid detergent on the stainless steel. With scouring side of sponge, scrub WITH THE GRAIN of the stainless steel and rinse with clean water.



CALENDAR MAINTENANCE

	CLEANING	TIME SCHEDULE
1	Combustion chamber	Daily - Every use
2	Cooking floor	Daily - Every use
3	Oven outside	Weekly
4	Stainless-steel parts	Weekly
5	Steel protection	Monthly
6	Burner	Monthly
7	Rust spots	Yearly
8	Nozzles	Biennially

PROTECTIVE MAINTENANCE

1 - COVER YOUR OVEN.

ALFA makes covers for all ovens. Make sure you protect your investment by covering your oven with an ALFA Ovens branded cover!



2 - EVERY 1-2 YEARS - CLEAN MINOR RUST SPOTS

304 Stainless steel is rust-proof but in some case (humidity, sea salt, etc.) some rust spots may appear. You can use a rust remover to get your stainless steel perfect again. your oven with an ALFA Ovens branded cover!



We also recommend both Barry's Restore It All or Bar Keepers Friend products for cleaning ALFA Stainless Steel Surfaces

www.barrysrestoreitall.com
www.barkeepersfriend.com

MAINTENANCE AND CARE

SPECIFICATIONS FOR WOOD-FIRED OVENS

- Before lighting the oven make sure that **the chimney flue is unobstructed** and that any previous ash has been removed.
- When the fire is out and the oven not too hot, collect the ash from previous cooking with a wire brush and a shovel.
- The oven can be used all year round; in the winter months, heat the oven with a small fire to avoid thermal shock due to humidity.
- **Creosote** - Formation and need for removal. When the wood is burned slowly, it produces organic vapors which combine with moisture to form creosote. Creosote vapors condense in the flue and accumulate on the inner surface of the flue.
- The chimney should be **inspected** at least twice a year for creosote build-up. When you observe excessive creosote, it should be removed to reduce the risk of fire.
- **Remove and sweep the chimney flue** once a year: birds nesting in it or other obstructions can lead to hazardous blockages.

MAINTENANCE AND CARE

SPECIFICATIONS FOR GAS-FIRED OVENS

1. MAINTENANCE.

The gas burner should be cleaned periodically by carefully sucking up any food residue. When cleaning valves and burners, be careful not to damage the burner. Do not enlarge the burner holes (The openings where the gas escapes).

2. GAS BURNER DISASSEMBLY

- Before cleaning the gas burner, remove it from the oven by proceeding as follows:
- Remove the front knob **(A)**.
 - Unscrew the fixing screw **(B)**.
 - Unscrew the fixing screws and remove the protection casing **(C)**.
 - Remove the gas box **(D)** to expose the connection of the piezoelectric ignition cables **(E)**.
 - Disconnect the two piezoelectric ignition cables. If need be, remove the protection casing by unscrewing the screw **(F)** and pull the burner out.
 - Clean the burner.
 - To assemble the burner, repeat the procedure in reverse order.

3. OVEN STORAGE

- If the gas-fired oven is not used, shut off the supply valve of the gas bottle.
- If the gas-fired oven is stored in a closed space, disconnect the gas supply. The bottle must be left outside in a well-ventilated area.
- In the event that the gas bottle is not taken out of the oven, place the whole lot in a well-ventilated area.
- The gas bottles must be stored outdoors in a well-ventilated area and out of reach of any children. Unused bottles shouldn't be stored in a building, garage or other enclosed space.



MAINTENANCE AND CARE

ONLY FOR WOOD VERSION

CLEANING

When the fire has gone out and the oven is not hot enough, collect the ashes left over from previous cooking with a metallic brush and a pan.

MAINTENANCE AND CARE

ONLY FOR GAS VERSION

MAINTENANCE

- The gas burner should be cleaned periodically by carefully sucking up any cooking residues.
- When cleaning valves and burners, be careful not to damage the burner.
- Remove any residues from the burners with a brush.
- Do not enlarge burner holes (openings).

GAS KIT DISASSEMBLY

- The gas burner should be cleaned periodically by carefully sucking up any cooking residues.
- When cleaning valves and burners, be careful not to damage the burner.
- Before cleaning is necessary to remove the burner from the oven by following the procedure in the assembly instructions.

STORING THE OVEN

- If the gas oven is not used close the supply valve of the gas cylinder.
- If the gas oven is placed in a closed space, disconnect the gas supply. The gas cylinder must be left outside in a well-ventilated area.
- In the event that the cylinder is not removed from gas oven, place the entire device and the cylinder in a well-ventilated outdoor area.
- The gas cylinders must be stored outdoors in a well-ventilated area and out of the reach of children. Cylinders not in use must not be stored in a building, garage or other enclosed space.

Alfa Forni is not responsible for veins, cracks, hairline cracks of the floor as they are an intrinsic characteristic of the material.

VENTING GUIDE FOR WOOD FIRED AND GAS OVENS



One of the most common questions for ALFA Oven owners revolves around venting. Many owners find the need to customize the basic vent pipe and cap that comes supplied with your oven. We hope the following information will help whether you're looking to extend your supplied pipe, add a bend to your supplied pipe or more complex projects that need converted to double wall chimney as well as penetrating overhead objects and roofing.).

PROJECTS REVIEWED

- Outdoor installation with no overhead obstructions
- Outdoor installation with overhead obstructions
- Indoor installation–Vertical direct vent approved–MUST use UL103HT double wall chimney
- Any customized installation beyond the supplied single wall pipe and cap, ALFA highly recommends that you contact your planning, building and zoning officials to ensure all local building codes are followed along with necessary permits, where needed.
- DO NOT CONNECT THIS TO A CHIMNEY FLUE SERVING ANOTHER APPLIANCE

Our dedicated Venting Specialist will work with you or your architects and contractors to identify the best solution for your chimney layout. You'll have peace of mind knowing that your venting system has all the UL listings, so you won't have to worry about running into problems with the inspections process.

ALFA Venting | 570 350 7939
alfaventing@olympiachimney.com

DIRECT VENT, SINGLE WALL FLUE EXHAUST

When installing the ALFA Oven in your outdoor cooking area with the venting away from any structures or low ceilings, the ALFA supplied high quality stainless steel pipe and cap are sufficient and no additional piping is necessary.

You can customize these systems vertically to assist draw or to help with your install design. ALFA and LakeView do not offer custom pipe or chimney, but we can help with sourcing by starting with Olympia Chimney Supply/ Copperfield Chimney, LLC manufactured pipe and chimney products.

Supplied single wall wood stove flue pipe can always be upgraded to double wall chimney.



WARNING: Major causes of vent related fires is failure to maintain required clearances (air spaces) to combustible materials.

Note: The outer walls of oven may reach high temperatures, more than 125°F. Position the oven so it is not in contact with the wall or other furniture and make sure there is a gap of at least 3 inches (7.5cm) alongside and behind the oven if you are using fireproof materials, at least 8 inches (20cm) if you not using fire-resistant materials.

DIRECT VENT, DOUBLE WALL CHIMNEY

For indoor ALFA Oven venting installations, or outdoor settings where your wood fired oven will be under a roof structures, pergolas, or any type of ceiling/roof.

ALFA Stone Ovens LPG/NG have all been UL tested and certified for indoor installation using approved UL103HT double walled chimney exhaust systems.

UL103HT Double wall chimney can be installed up to 60 feet vertically and must be a minimum of 3 feet above the roof or structure it is penetrating.

If you are penetrating through an overhead object you must remove supplied single wall pipe and start with Olympia Chimney Supply/Copperfield Chimney LLC manufactured pipe and chimney products

If a bend is needed to change the pipe or chimney direction to avoid an obstruction, you can use up to (2) 30-degree or less angles but NEVER together to form a 60-degree bend..





ALFA OVENS VENTING GUIDE FOR WOOD FIRED OVENS

Basic Guideline for ALFA Ovens Flue and Obstruction Clearances:

- Single Wall Flue Piping: Allow 18" of clearance around pipe
- Double Wall Flue Chimney: Allow 3" of clearance around chimney
- Combustible Clearance: Minimum of 3 feet below the ceiling is required
- Chimneys must extend at least 3 feet above the highest point where it passes through a roof, and at least 2 feet higher than any portion of a building within 10 feet
- Never fill any required clearance with any insulation or other materials

OFFSET ELBOW INSTALLATION:

- Avoid elbows if at all possible, as a vertical pipe or chimney is the most efficient
- Pipe or chimney systems may have a maximum of 2 offsets (two elbows total) of 30-degrees from vertical
- Elbows are manufactured in 15-degree and 30-degree angles, measured from the vertical
- Do not combine elbows to create steeper angles and never exceed 2 elbows in one pipe or chimney system
- A single elbow is defined as a 30-degree bend and then a 30-degree correction (one set)
- For Example: You could have a 30-degree bend with a 0-48" horizontal pipe or chimney and then another 30-degree bend back to the vertical position
- Do not use with forced-draft, positive-pressure appliances.

WARNING: DO NOT USE (2) 30-DEGREE ELBOWS TO CREATE A 60-DEGREE ANGLE!

THIS VOIDS ALL WARRANTIES AND PRESENTS A FIRE HAZZARD WITHIN THE PIPE OR CHIMNEY SYSTEM.

If your installation requirement cannot meet the basic standards be sure to consult a professional and obtain necessary permits in advance.



ALFA Venting | 570 350 7939
alfaventing@olympiachimney.com

NORTH AMERICA ONLY

lvdistributes.com

1065 W North Thorndale Ave | Bensenville, IL 60106 | 630 238 1280

Appliance Distribution Service, Parts, Installation & Delivery

TROUBLESHOOTING WOOD-FIRED OVENS

<p>CRACKED GASBETON OR FIREBRICK</p>	<ul style="list-style-type: none"> - Firebricks can crack and pose no problems or performance issues when cooking on your ALFA Oven. - Gasbeton insulation brick is inherently brittle and many times is cracked from large pieces just to get into the oven mouth for placement under the firebrick in assembly. This is completely normal. - If you ever have a cavity in either of your bricks you can turn it and use the other side or replace it. - All ovens come with an extra fire brick if you would need to replace one. - If you feel any of the bricks are too damaged for use please contact Lakeview Customer Service
<p>THE OVEN PRODUCES SMOKE</p>	<ul style="list-style-type: none"> - Check that the wood is not too moist and the embers are not unburned. - Make sure that you have started a fire with vivid flames, gradual but steady, in order to avoid incomplete combustion. - If the oven is installed indoors, check the chimney flue and any air inlets in the room. - It is recommended to close the oven door.
<p>THE OVEN DOES NOT HEAT</p>	<ul style="list-style-type: none"> - Check that the fire is on one side of the oven and not near the mouth - Fire with vivid flames for 20minutes. - Do not amass the wood over the embers. - Gradually add the wood to the fire.
<p>THE OVEN COOLS DOWN QUICKLY</p>	<ul style="list-style-type: none"> - Check that no moisture or water has infiltrated the oven. - It may be lit for the first time or after a long idle period. - Avoid sudden short fires that do not warm the bottom of the oven.
<p>THE FLAMES COME OUT OF THE MOUTH OR CHIMNEY CAP</p>	<ul style="list-style-type: none"> - Avoid excessive fires and immediately dampen the flames that reach out of the oven by resting the door over the mouth of the oven, leaving a gap of 1-2 inches.
<p>CAN YOU PUT THE OVENS RIGHT ON THE COUNTERTOP WITHOUT USING THE SUPPLIED FEET?</p>	<ul style="list-style-type: none"> - No, the feet must be used to allow for air to flow beneath the bottom of the oven floor

Contact us directly for expert advice on the web site
www.alfaovens.com

TROUBLESHOOTING GAS-FIRED OVENS

<p>CANT GET THE PILOT TO LIGHT</p>	<ul style="list-style-type: none"> - Check that the knob is not going in too far and hitting the oven preventing the pilot to allow gas for ignition.
<p>IGNITION DOESN'T WORK</p>	<ul style="list-style-type: none"> - Make sure the battery is new and has power
<p>CAN YOU PUT THE OVENS RIGHT ON THE COUNTERTOP WITHOUT USING THE SUPPLIED FEET?</p>	<ul style="list-style-type: none"> - No, the feet must be used to allow for air to flow beneath the bottom of the oven floor

ELECTRONIC BUTTON ONLY FOR GAS OVENS

The ignition button comes with AA battery included. To install it, follow this procedure.

1. Unscrew the button head.
2. Put in the battery.
3. Screw the button head.

Carry out these operations when the oven is off.

Remove the battery during long periods of inactivity.



Contact us directly for expert advice on the web site
www.alfaovens.com

