

Reference Manual

# Solaira Cosy

CANADA & USA HEATER MODELS:

SCOSY15120-C	120V - 1500W
SCOSY15240-C	208 / 240V - 1125 / 1500W (SINGLE PHASE)

C = COLOR CODE

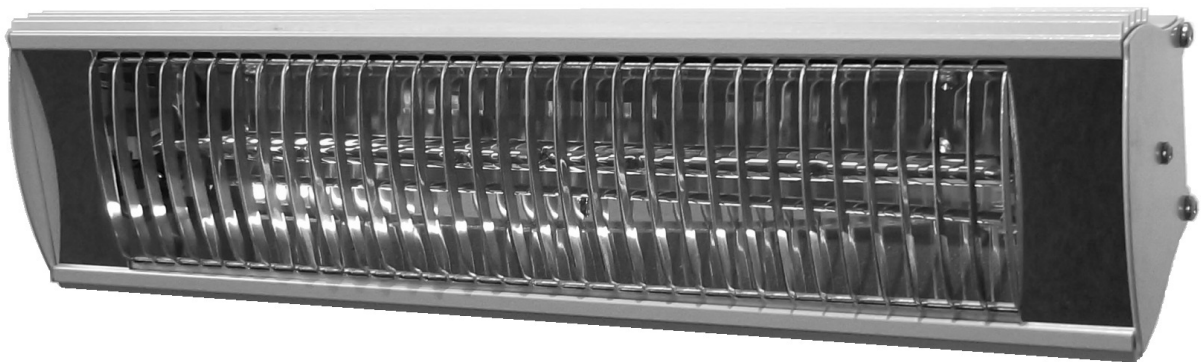

**WEATHERPROOF INFRARED HEATERS  
SUITABLE FOR OUTDOOR AND INDOOR USE -  
RESIDENTIAL, COMMERCIAL AND INDUSTRIAL**



**INFORESIGHT CONSUMER PRODUCTS INC.**

125 Traders Blvd. E Unit # 4, Mississauga, Ontario L4Z 2H3

Tel: 905-568-7655 - Fax: 905-568-7521

Email: [info@solairaheaters.com](mailto:info@solairaheaters.com) - Website: [www.solairaheaters.com](http://www.solairaheaters.com)

**⚠ IMPORTANT - SAVE THESE INSTRUCTIONS FOR FUTURE REFERENCE**



## IMPORTANT INSTRUCTIONS



When using electrical short-wave INFRARED HEATERS, basic precautions should always be followed to reduce the risk of fire, electric shock, and injury to persons, including the following:

1. **Read all instructions before using this heater.**
2. Use this heater only as described in this manual. Any other use not recommended by the manufacturer may cause fire, electric shock, or injury to persons.
3. This heater is hot when in use. To avoid burns, do not let bare skin touch hot surfaces. If provided, use handles when moving this heater. Keep combustible materials, such as furniture, pillows, bedding, papers, clothes, and curtains at least 6 feet (1.8m) from the front of the heater and keep them away from the sides and rear.
4. Extreme caution is necessary when any heater is used by or near children or invalids and whenever the heater is left operating and unattended.
5. Always unplug heater when not in use.
6. Do not operate any heater with a damaged cord or plug or after the heater malfunctions, has been dropped or damaged in any manner. Return heater to authorized service facility for examination, electrical or mechanical adjustment, or repair.
7. This heater is not intended for use in bathrooms, laundry areas and similar locations. Never locate heater where it may fall into a bathtub or other water container.
8. Do not run cord under carpeting. Do not cover cord with throw rugs, runners, or the like. Arrange cord away from traffic area and where it will not be tripped over.



## IMPORTANT INSTRUCTIONS



9. To disconnect heater, (if hard wired) turn controls to off or remove 3-pin 120 volt plug from outlet.
10. Connect to properly grounded outlets only.
11. Do not insert or allow foreign objects to enter any opening as this may cause an electric shock or fire, or damage the heater.
12. To prevent a possible fire, do not block openings in any manner.
13. A heater has hot parts inside. Do not use it in areas where gasoline, paint, or flammable liquids are used or stored.
14. Avoid the use of an extension cord because the extension cord may overheat and cause a risk of fire.
15. Do not cover or otherwise obstruct the heater.
16. Do not touch the heater during operation as the body becomes very hot and cause burns. Particular attention has been given where children and vulnerable people are present.



## SAVE THESE INSTRUCTIONS



### GROUNDING INSTRUCTIONS

For the 120 volt heater. The cord has 3-pin grounded plug.

For the 208 / 240 volt heater. The cord from the terminal box must be hard wired.

# INTRODUCTION

The Cosy heater produces radiant heat like the sun, warming people and objects rather than the air in between. It is mounted on an adjustable bracket that allows the heat to be directed exactly where it is required. Its attractive, lightweight design means that it is effective yet unobtrusive. The infrared radiant weatherproof heater is designed for indoor and outdoor use.

**Please read the following instructions carefully before use. The safety of this heater is guaranteed only by its correct usage in accordance with these instructions, therefore they should be retained for future reference.**

## CAUTION

Before using this appliance:

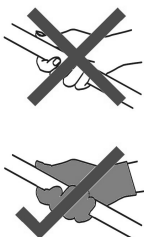
1. Check that the voltage indicated on the units rating label corresponds to the mains supply voltage.
2. Do not install the heaters less than the minimum height from the floor as specified below in the specification - Table. 1.
3. Ensure that the heater has been securely fastened in its final mounting position.
4. **WARNING** - This appliance must be grounded! 
5. **WARNING** - Keep the mains cord away from the body of the heater which will get hot during use.
6. If a socket outlet is used do not position the outlet immediately behind the heater.
7. Avoid the use of an extension cord with this product.
8. Do not cover or obstruct the heater while it is in use.
9. Do not insert any object through any slot or opening in the heater.
10. Do not use if guard is not present.
11. **WARNING** - When replacing the emitter or cleaning the unit, ensure that the 3-pin 120 volt plug is removed from its socket outlet or if hard wired circuit is disconnected from the mains supply. **Note:** always ensure that the emitter is cool before handling.
12. Do not handle the halogen emitter with bare hands. If it is inadvertently touched, remove finger marks with a soft cloth and methylated spirit or rubbing alcohol. Otherwise, the marks will burn into the quartz emitter during use causing premature heater failure. 
13. The heater is not intended for use by young children and must be supervised by a responsible person at all times.
14. Always remove the 3-pin 120 volt plug on the 120 volt heater if it is not being used.



## WARNING: RISK OF FIRE



Keep combustible material such as furniture, papers, clothes and curtains at least 6 feet (1.8m) from the front of the heater and away from the sides and rear.

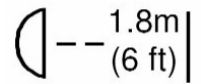

## SPECIFICATION

Table 1. Canada and USA Heaters

Model Type	SCOSY15120	SCOSY15240
Voltage	120 V	208 / 240 V
Total Power	1500 W	1125 / 1500 W
Current	12.5 A	5.4 / 6.3 A
Min. mounting height from floor	79 in (201 cm)	
Min. distance from ceiling	11 ¾ in (30 cm)	
Min. distance from side wall	39 in (100 cm)	
Dimensions - W x H x D	15½ in x 4 in x 6 in (39 cm x 10 cm x 15 cm)	
Weight	5.1 lbs (2.3 kg)	

## INSTALLATION

The 120V version of the heater is fitted with a supply cord measuring 15 feet (5.0m) and has a molded 3 - pin 15 amp plug.

The 208 / 240V version of the heater is fitted with a supply cord measuring 79 inches (2.0m) for hard wiring.

**WARNING:** Wiring procedures and connections should be in accordance with the National Electric Code (NEC) and local codes.

**WARNING:** If the supply cord becomes damaged, it must be immediately replaced by a qualified person in order to avoid a hazard.

**CAUTION:** Disconnect electric power supply before working on circuit wiring to prevent electric shock.

**CAUTION:** Please observe the minimum safe distance between the heater body and any inflammable surfaces.

**CAUTION:** When the electrical connection is outside a weatherproof socket must be used having ground fault protection (GFCI or GFI).

**NOTE: CONSULT A QUALIFIED ELECTRICIAN, IF IN DOUBT.**

# MOUNTING

**CAUTION**  
 Switch off/unplug the heater from the mains supply when mounting or adjusting the heater position.

The heater can be mounted in a horizontal manner (Fig. A) or angled manner (Fig. D).

1. Securely fasten the heater bracket to the mounting surface using the fixing holes in the bracket. Please refer to Table 1 for recommended positioning of the heater.

2. Fix in the required angular position by tightening the fixing bolt on the bracket at the rear of the heater.

3. The heater bracket can be used to adjust the direction of the heater up and down (see Fig. B) and side to side (see Fig. C). This is done by loosening the bolts fixing the heater to the bracket, and then retightening once the correct position is achieved.

**CAUTION:** When mounting the heater horizontally, do not position the heater at an angle more than 50° or less than 45° as shown in Fig. A.

**CAUTION:** The heater should be mounted with the minimum clearances adhered to. Please refer to Table 1 for the recommended positioning of the heater. Do not install the heater in a corner!

**CAUTION:** When mounted the heater at an angle, ensure the back of the heater is parallel to the mounting surface (See Fig. D). The heater should always be angled downwards when mounting this way with the terminal box at the bottom of the heater - see Fig. D.

**CAUTION:** Always allow the heater to cool before attempting to reposition/move. Never attempt to move the heater while it is switched on!

**CAUTION:** Observe the minimum safe distance between the heater body and inflammable surfaces and objects when mounting (see table 1).

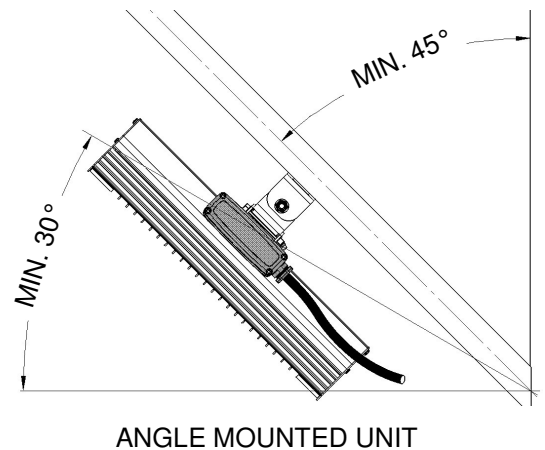
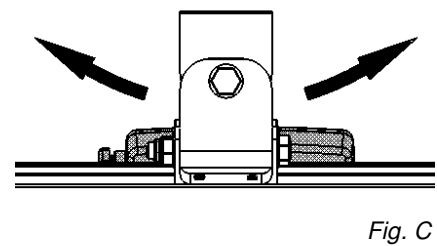
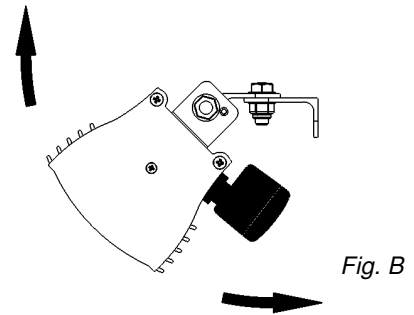
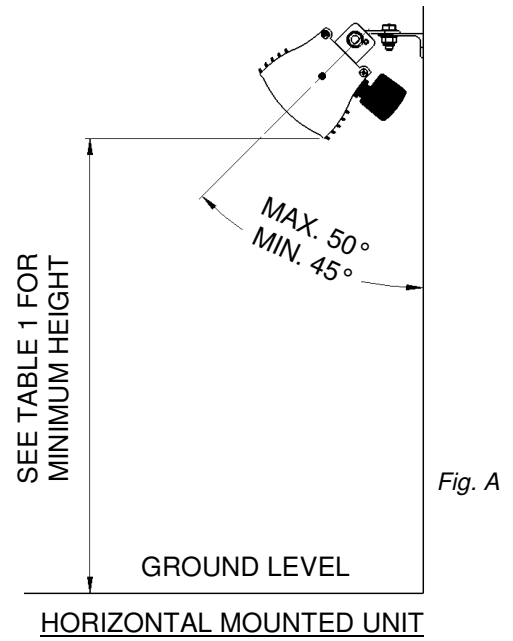

Fig. D

## MAINTENANCE

**!** **NOTE:** For replacement emitters or spare parts please contact your local distributor quoting model type and rating from rating label. It is very important that your replacement emitter is exactly the same as the one it was supplied with. Failure to fit the exact same type can cause the heater to prematurely fail.

**⚠ CAUTION:** Unplug/Switch off unit from the mains supply before replacing emitter or any maintenance procedure including cleaning.

**⚠ CAUTION:** Should dust or dirt appear on the reflector, it is recommended that the guard and emitter are removed and the reflector is wiped with a lint-free cloth before reassembling (see emitter replacement instructions).

## REPLACING THE EMITTER

**!** **CAUTION** **!**  
Unplug/switch off from the mains power before any attempts are made to replace the emitter. Contact your distributor for the correct replacement quoting model type and rating from rating label. We recommend you read through the procedure fully before commencing work.

1. Ensure the heater and emitter are cool and the power supply is disconnected by removing the plug from the socket outlet or disconnect switch.

2. Remove one of the heater end plates by removing the three screws with a pozi-head screwdriver as shown in Fig. E.



3. The heater will now be free to slide off the back plate (Fig. F). Gently slide the heater body away from the open end as shown in Fig. G ensuring not to drop it as it becomes free from its mounting.

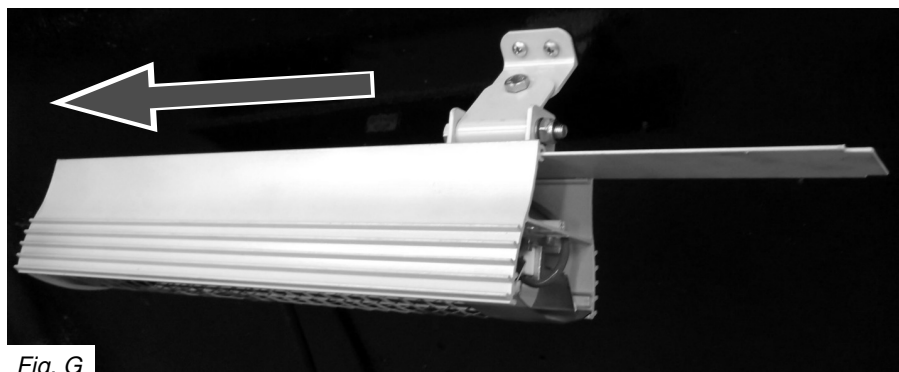

4. The back plate should now have the heater body removed from it (Fig. H) and can be placed on a safe, flat work surface to proceed with the emitter replacement.

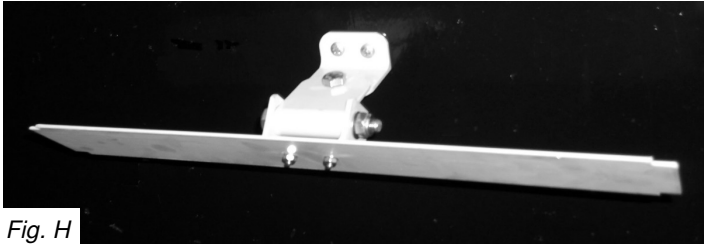

5. Stand the heater on its open end and remove the other end plate (Fig. J).

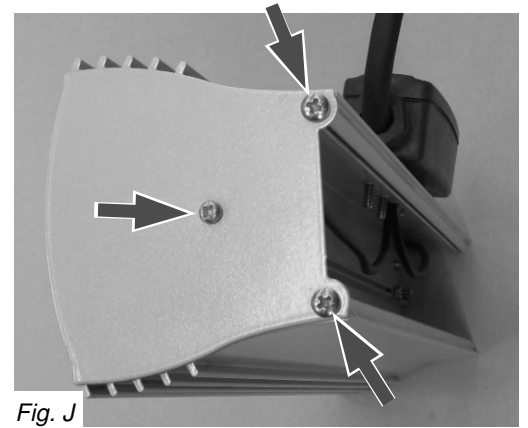

6. Remove the four screws (Fig. K) from the terminal box and lift off the lid.



7. Remove the connector block retaining bridge by removing the screw and lifting out. This will allow the connector block to be lifted out of its locating lugs to allow for better access when connecting the new emitter terminals. For now though leave it in its locating lugs and unscrew the connector block screws as highlighted (Fig. L) and remove the white emitter wires so they are free (Fig. M).

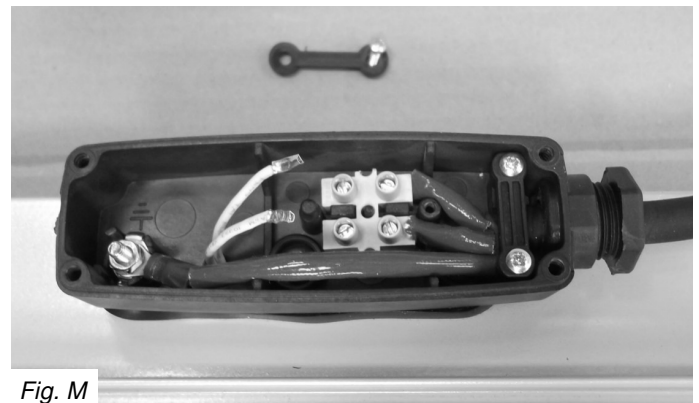
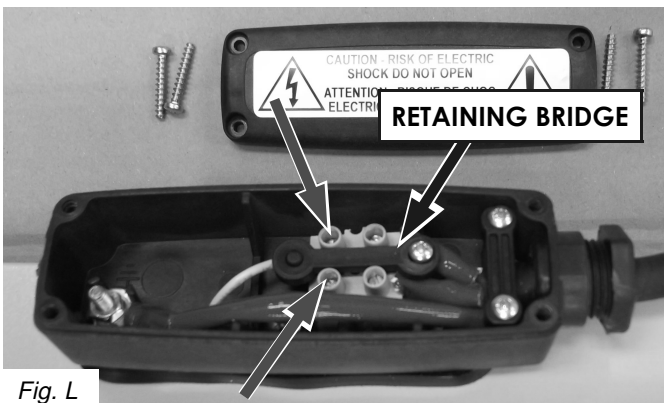

8. From inside the heater body, gently pull the emitter wires through the sealing gasket so the emitter wires exit the terminal box and are free as shown below in Fig. N.

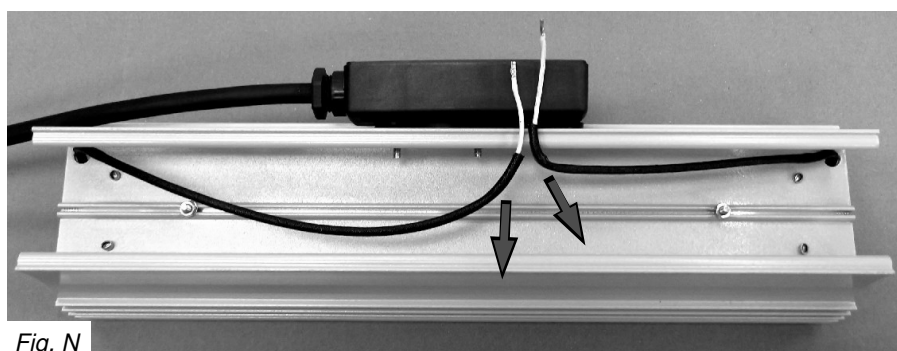



**9.** Turn the heater body over and slide the side reflectors out at each end and then slide the guard out of the heater by pushing it towards one of the ends where the end plates are removed (Fig. P). NOTE: The reflectors sit on top of the guard legs for refitting.



Fig. P

**10.** Pull the emitter wires through the two access holes so it is ready to be unclipped and removed from the heater (Fig. Q).



Fig. Q

**11.** The emitter is held in at each end by spring clips that hold the emitters' ceramic caps in the emitter holders. Pull the clips back (Fig. R) far enough to allow the ceramic caps to be lifted up (Fig. S) at both ends and remove the emitter from the heater.

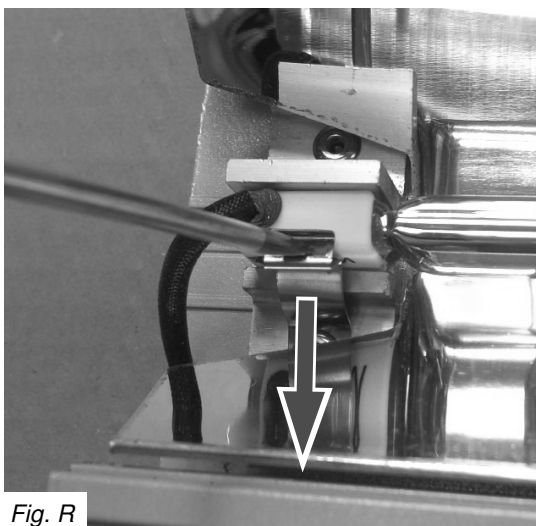

Fig. R

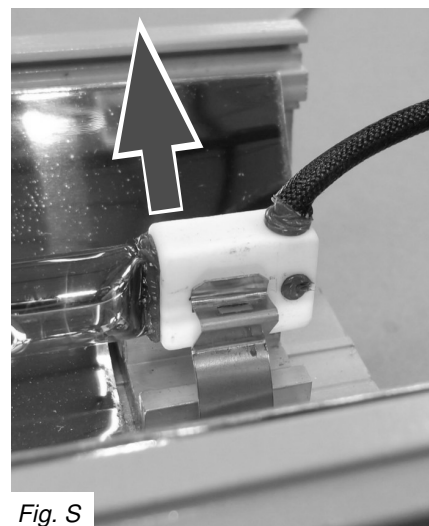

Fig. S

12. The heater should now be broken down as shown in Fig. T. Ensure your new emitter wires are the same length and it's fitted the same as the original.

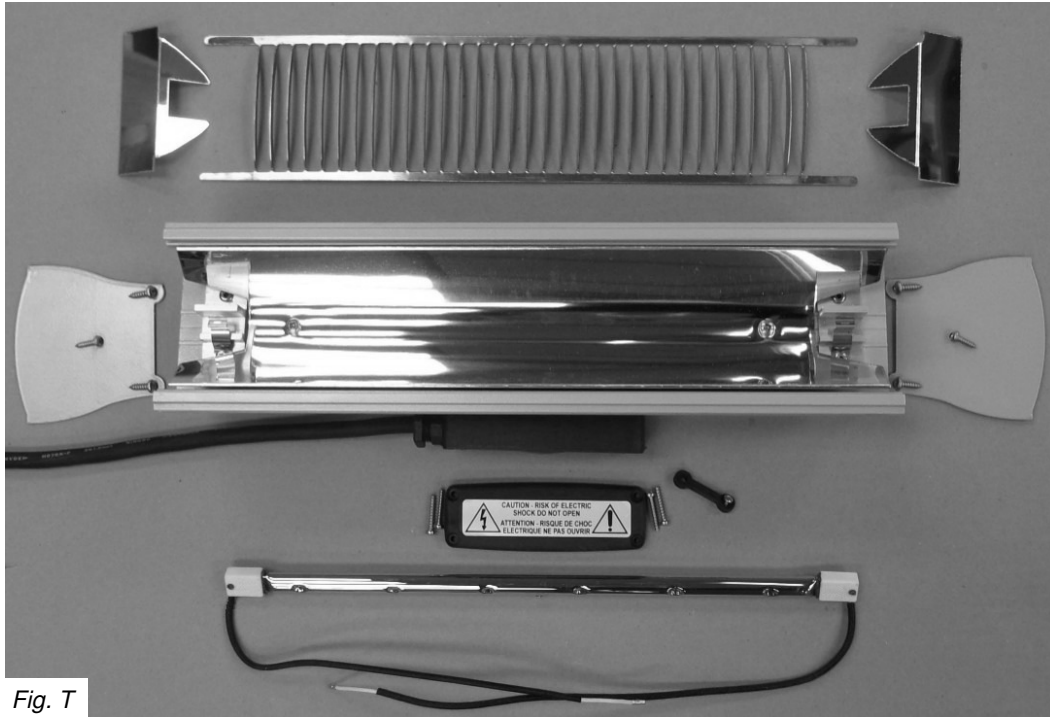

Fig. T

13. Refit the new emitter in reverse order ensuring that no wires get trapped and all screws are fully tightened.



**IMPORTANT - SAVE THESE  
INSTRUCTIONS FOR FUTURE REFERENCE**

---

**INFOSIGHT CONSUMER PRODUCTS INC.**

125 Traders Blvd. E Unit # 4, Mississauga, Ontario L4Z 2H3  
Tel: 905-568-7655 - Fax: 905-568-7521  
Email: [info@solairaheaters.com](mailto:info@solairaheaters.com) - Website: [www.solairaheaters.com](http://www.solairaheaters.com)



Due to our policy of ongoing improvement, we reserve the right to make changes without notice.

© 2015 INFOSIGHT CONSUMER PRODUCTS INC.

Ref No. 043143EN Issue No. 1