

合格证
QC PASS

Godox

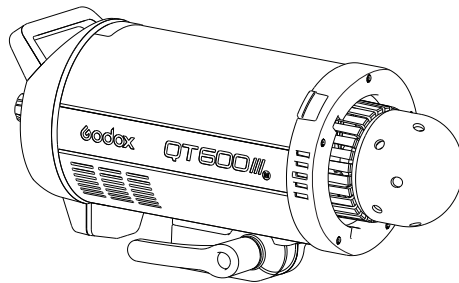

Wechat
Official Account
神牛微信公众号

深圳市神牛摄影器材有限公司

地址：深圳市宝安区福海街道塘尾社区耀川工业区厂房2栋 电话：0755-29609320(8062)
传真：0755-25723423 邮箱：godox@godox.com

GODOX Photo Equipment Co.,Ltd.

Add.: Building 2, Yaochuan Industrial Zone, Tangwei Community, Fuhai Street, Bao'an District, Shenzhen
518103, China Tel: +86-755-29609320(8062) Fax: +86-755-25723423 Email: godox@godox.com

www.godox.com

Made in China | 705-QT63M0-00



QT400Ⅲ (M)
QT600Ⅲ (M)
QT1200Ⅲ (M)

高速影室闪光灯
Quicker Studio Flash

使用手册
Instruction Manual

前言

感谢您购买QTIII系列高速闪光灯。

此系列产品适用广泛,除了能满足各种摄影工作室及影棚的日常拍摄,还特别适用于捕捉物体运动轨迹的拍摄,如动态摄影,舞台摄影,体育摄影,科学研究摄影等。另外,在时尚摄影或人像摄影中,可使用连拍功能,连续捕捉模特一现即逝的精彩表情。

产品有以下亮点:

- 极速回电, 0.01-0.9 秒回电时间
- 实现相机高速同步最高 1/8000
- 高速连拍每秒可达 10 张
- 闪光强度随意选择, LCD 屏从1/256~1/1 准确定位输出功率
- 40W 大功率LED造型灯, 无极调节亮度
- 输出稳定,同一功率高速连续输出变化不超过2%
- 近日光色温,全程色温变化<200K(色温恒定模式)
- 内置2.4GHz无线系统
- 装载 S1/S2 光控引闪, 可做副灯使用
- 配置 Delay 延时功能, 创造更多特色的创意拍摄
- 具备 Mask 蒙板功能, 后期修图迅速便捷
- 配置高品质 LCD 液晶屏, 直观易用

警告

在使用本设备前请仔细阅读以下警告内容, 并妥善保管以便所有本产品使用者可随时参阅。

- ⚠ 请勿私自拆卸产品, 如产品出现故障须由本公司或授权的维修人员进行检查维修。
- ⚠ 请保持干燥: 请勿用湿手接触产品, 亦不可将产品浸入水中或暴露于雨中。
- ⚠ 请勿让儿童接触本产品。
- ⚠ 闪光灯适用于通风的环境,使用时请保持灯光源部分及散热孔不被堵塞, 请勿在易燃易爆的环境中使用。
- ⚠ 闪光灯采用电源插头做为断接装置, 应保持随时便于操作。
- ⚠ 使用时严禁用手接触灯光发热部件。
- ⚠ 安装及连接附件时, 请关闭开关断开电源, 装卸闪光灯管/造型灯时, 请确认灯管为冷却状态, 避免烫伤, 还需佩戴绝缘手套。
- ⚠ 请勿将闪光灯头正对人眼闪光(特别是婴儿的眼睛), 否则可能会在短时间造成视力障碍。
- ⚠ 在不使用时, 请断开电源。



注意事项

- ⚠ 闪光灯在全功率的情况下连续引闪30次后, 需冷却3分钟左右。如果连续使用而冷却就会产生高温积热。
- ⚠ 不可长时间连续使用造型灯, 否则可能造成安装在灯头上的柔光箱等易燃附件燃烧。有易燃附件时建议不要连续使用造型灯超过10分钟。如使用超过10分钟, 请冷却1分钟后再继续使用。
- ⚠ 使用束光筒时, 请勿长时间点亮造型灯或过频闪光(全功率每分钟不多于6次)。积热会导致闪光灯外壳受损或造成灯的损坏。
- ⚠ 避免突然的碰撞, 防止闪光灯管或造型灯受损。

目录

- 1 前言
- 2 警告
- 3 注意事项
- 5 部件名称
 - 机身
 - LCD液晶显示屏
 - 所配附件
 - 可选购附件
- 7 使用闪光灯
 - 固定闪光灯
 - M:手动闪光
- 8 色温恒定模式及凝固(speed)模式
- 9  高速同步闪光
- 10 Multi:频闪闪光
- 11 无线闪光拍摄：无线电(2.4G)传输
 - 无线设置
 - 设置通讯频道
 - 设置通讯组别
- 12 光控模式
 - 造型灯
- 13 声音提示
 - C.Fn设置自定义功能
- 14 其他应用
 - 记忆存储功能
 - 装卸闪光灯管
- 15 规格参数
- 16 维护保养

本说明书中使用的约定

- 此使用说明书中的操作步骤假定相机和闪光灯的电源开关已开启。
- 参考页码由(第**页)表示。
- 此使用说明书中使用以下警告符号：
 -  该“小心”符号表示避免出现拍摄问题的警告。
 -  该“注意”符号提供补充信息。

部件名称

机身:

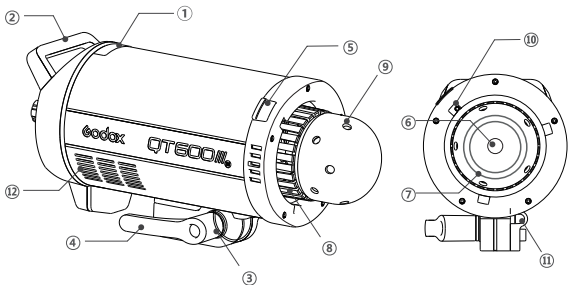

- | | |
|----------|---------|
| ① 光控接收 | ⑧ 散热器 |
| ② 把手 | ⑨ 玻璃灯罩 |
| ③ 托架 | ⑩ 保荣卡口 |
| ④ 方向调节把手 | ⑪ 伞孔 |
| ⑤ 灯罩卡口推制 | ⑫ 风扇进风口 |
| ⑥ LED造型灯 | ⑬ 风扇出风口 |
| ⑦ 灯管 | |

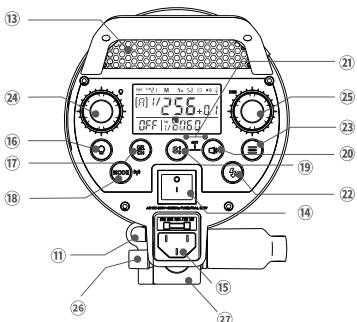

- | |
|----------------------|
| ⑬ 船形开关 |
| ⑭ 电源插座 |
| ⑮ 造型灯按键 |
| ⑯ GR/CH按键 |
| ⑰ MODE/无线按键 |
| ⑱ S1/S2按键 |
| ⑲ 蜂鸣器按键 |
| ⑳ RST(S1/S2+蜂鸣器)组合按键 |
| ㉑ 引闪按键 |
| ㉒ 菜单按键 |
| ㉓ 造型灯亮度调节旋钮 |
| ㉔ DIM多功能调节旋钮 |
| ㉕ 固定旋钮 |
| ㉖ 套筒 |
| ㉗ |

部件名称

LCD液晶显示屏

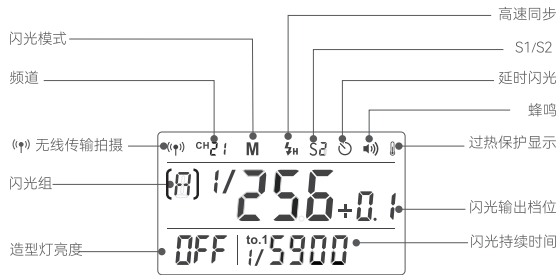

标配物品

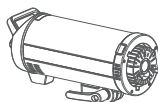

灯体 *1



灯头保护罩 *1



玻璃灯罩 *1



说明书 *1



电源线 *1



灯管 *1

可选购附件

可搭配本公司以下摄影附件使用,以获得最佳的拍摄效果和使用体验:带2.4G无线发射功能的引闪器和机顶灯、逆变器、柔光箱、反光伞、灯架、蜂巢、雷达罩、束光筒等。



使用闪光灯

固定闪光灯

1、取下灯头保护罩,装上灯管并套上玻璃灯罩。

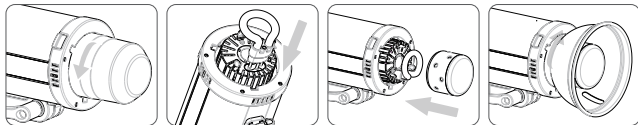

2、将闪光灯设备安装在一个合适的灯架上,调整托架并扭紧固定,方向调节把手可按用户需求调节灯的方向。伞孔可以插上各类影楼伞。

M: 手动闪光

在此模式下,您可以在1/1全功率至1/256功率间以1/10档为增量设置闪光输出。为获得正确的闪光曝光,请使用手持的闪光测光表确定所需的闪光输出。



1 按<MODE>模式选择按钮,屏幕显示<M>。



2 按转动DIM多功能调节旋钮设置闪光输出功率。

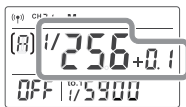

显示闪光持续时间

闪光持续时间是指闪光灯从开始发光到达发光半峰值的时间长度。半峰值的表示为 $t=0.5$ 。

为了给摄影师提供更详细的拍摄数值,本产品采用 $t=0.1$ 。

如右图: $t=0.5$ 与 $t=0.1$ 区别。

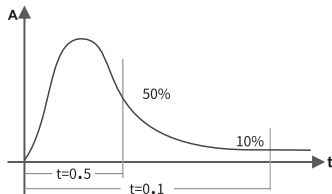

只有在M模式下才会显示持续时间。

色温恒定模式: 进入MENU C.Fn-F1, 设置为OFF, 色温恒定开启, 该模式下全档位色温漂移在 $\pm 200K$ 。在色温恒定模式下功率值由大调小, 引闪按键指示灯闪烁(蜂鸣器响起), 此时请按引闪按键进行放电, 放电后可正常使用。

色温恒定模式及凝固闪光(speed)模式

在C.Fn-F1设置中可以选择色温恒定模式或者高速闪光(speed)模式。此2种模式在M/Multi闪光模式下有效。高速同步模式下此2种模式无效。

色温恒定模式(默认): 全程色温漂移 $< 200K$ 内, 追求色温稳定性的摄影师请选择此模式。

凝固(speed)模式, 最快闪光持续时间 $t_{0.1} = 1/26100$, 需要凝固运动物体拍摄的请选择此模式。此模式下色温偏高, 请摄影师把相机的白平衡参数调整至相应的色温值(参考下表值)或者自动白平衡。

QT600IIM					
测试环境	暗房				
色温测试	仪器	SEKONIC C-800			
	测试方法	距离 1 米引闪, 测量 3 次求平均值			
闪光持续时间 ($t_{0.1}$)	IGBT 控制闪光灯的打开时间				
色温恒定模式			高速闪光 (speed) 模式		
档位	色温 CCT(K)	闪光持续时间 $t_{0.1}(S)$	档位	色温 CCT(K)	闪光持续时间 $t_{0.1}(S)$
1/256	5734	1/6010	1/256	8378	1/26100
1/256+0.3	5760	1/5560	1/256+0.3	8471	1/25800
1/256+0.7	5745	1/5420	1/256+0.7	8024	1/24700
1/128	5729	1/5170	1/128	9335	1/24100
1/128+0.3	5718	1/4940	1/128+0.3	9108	1/23400
1/128+0.7	5686	1/4830	1/128+0.7	9010	1/19300
1/64	5619	1/4680	1/64	8535	1/16500
1/64+0.3	5635	1/4400	1/64+0.3	8205	1/13900
1/64+0.7	5657	1/3970	1/64+0.7	7698	1/12700
1/32	5630	1/3700	1/32	7367	1/11400
1/32+0.3	5639	1/3530	1/32+0.3	7151	1/10300
1/32+0.7	5608	1/3110	1/32+0.7	6856	1/9500
1/16	5620	1/2940	1/16	6579	1/8700
1/16+0.3	5647	1/2760	1/16+0.3	6440	1/7800
1/16+0.7	5657	1/2360	1/16+0.7	6216	1/6700
1/8	5677	1/2090	1/8	6126	1/5700
1/8+0.3	5674	1/1920	1/8+0.3	6072	1/5000
1/8+0.7	5610	1/1670	1/8+0.7	5954	1/4100
1/4	5568	1/1400	1/4	5907	1/3500
1/4+0.3	5566	1/1250	1/4+0.3	5867	1/3000
1/4+0.7	5656	1/1060	1/4+0.7	5837	1/2200
1/2	5646	1/900	1/2	5844	1/1600
1/2+0.3	5681	1/770	1/2+0.3	5738	1/1200
1/2+0.7	5649	1/590	1/2+0.7	5636	1/690
1/1	5549	1/530	1/1	5539	1/530

⚡H 高速同步闪光

⚡H 高速同步

在此模式下,您可以在1/1全功率间至1/32功率间以1/10档为增量设置闪光输出。使用高速同步闪光,您可以在所有的快门速度下同步使用闪光灯。高速同步模式下,使用光圈优先对人像进行填充闪光时特别方便。

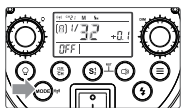

1 按<MODE>模式选择按钮,屏幕显示<⚡H>。



2 转动DIM多功能调节旋钮设置闪光输出功率。

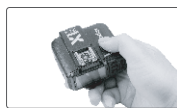

3 发射器请使用X1系列发射器(需另购)。

- 使用高速同步时,快门速度越高,有效的闪光范围就越小。
- 在高速同步模式下,无法设置频闪闪光。
- 在高速同步模式下,由于灯管特性,色温会偏低(下降700K左右),请将相机白平衡设置调至自动。

Multi: 频闪闪光

在此模式下,您可以在1/4至1/256功率间以1档为增量设置闪光输出。使用频闪闪光,可以发出一系列快速的闪光。它可以在一张照片上拍摄移动物体的多个图像。您可以设置闪光频率(每秒的闪光次数,以Hz表示)、闪光次数和闪光输出。

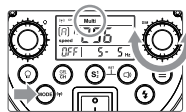

1 按<MODE>闪光模式选择按钮,屏幕显示<Multi>。

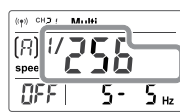

2 转动DIM多功能调节旋钮设置闪光输出功率。

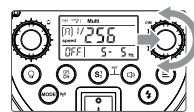

3 设置闪光频率和闪光次数。
• 按DIM多功能调节旋钮选择闪光次数,旋转DIM多功能调节旋钮设定数值。
• 按DIM多功能调节选择闪光频率,旋转DIM多功能调节设定数值。

计算快门速度

在频闪闪光过程中,到闪光停止为止快门应保持开启状态。使用下面的公式计算快门速度,然后用相机进行设置。

$$\text{闪光次数/闪光频率} = \text{快门速度}$$

例如,如果闪光次数是10,闪光频率是5Hz,快门速度则至少为2秒。

- 反光很强的被摄体在暗背景前使用频闪闪光更加有效。
- 推荐使用三脚架和遥控开关。
- 闪光输出为1/1和1/2时不能设置频闪闪光。
- 如果闪光次数显示为--,则闪光灯会连续闪光,直到快门耗尽。如下表所示,闪光次数将受到限制。

最大频闪闪光次数

闪光输出 \ Hz	1	2	3	4	5	6-7	8-9	10	11	12-14	15-19	20-30
1/4	7	6	5	4	4	3	3	2	2	2	2	2
1/8	7	6	5	4	4	3	3	2	2	2	2	2
1/16	14	14	12	10	8	6	5	4	4	4	4	4
1/32	30	30	30	20	20	20	10	8	8	8	8	8
1/64	60	60	60	50	50	40	30	20	20	20	18	16
1/128	99	99	90	80	80	70	60	50	40	40	35	30
1/256	99	99	90	80	80	70	60	50	40	40	35	30

无线闪光拍摄：无线电(2.4G)传输

QTIII系列内置2.4G无线X系统,可以与原厂其他型号完美结合使用。

尼康相机(使用X1T-N、TT685N等)和佳能相机(使用X1T-C、TT685C等)可同时同地共享一台或多台QTIII,无缝结合,无懈可击!

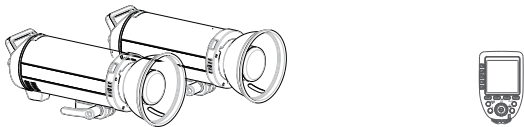

*QTIII作为从属单元,可受控主控单元型号: AD360II-C、AD360II-N、TT685系列、V860II系列、V1系列、XPro系列、X2T系列、X1T系列、TT600等。

无线设置

长按MODE/无线按键,令屏幕显示< >,此时进入2.4G无线状态。

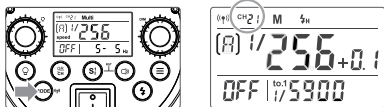

设置通讯频道

如果在拍摄现场不止一个无线闪光系统,您可以通过更改通讯频道来防止信号干扰。保证主控单元和从属单元设置为相同的频道编号即可。



设置通讯组别



光控模式

S1光控单元设置

按<S1/S2>按钮选择S1功能,闪光灯可作为副灯使用,创造多种照明效果,适用于手动闪光灯环境。它会与主闪光灯的第一次闪光同步触发闪光,效果与使用无线引闪器一致。

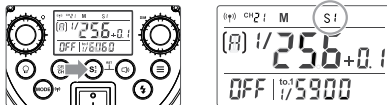

S2光控单元设置

按<S1/S2>按钮选择S2功能,闪光灯可作为副灯使用。具有防预闪功能,使用带一次预闪功能的相机能用光控实现同步拍摄。它会与主闪光灯的第二次闪光同步触发闪光,即2次光控引闪。

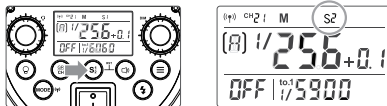

造型灯

QTIII配置40W LED造型灯,无极调控。

·造型灯有3种模式: OFF,百分比和PROP。短按造型灯按钮三种模式依次出现在显示屏上。

 OFF: 关闭造型灯。

 百分比: 1%~100%。

 PROP: RPOP: 通过改变输出功率来调整造型灯亮度,功率越大造型灯越亮。

旋转造型灯亮度调节旋钮调节造型灯亮度百分比(1%~100%)。

*小提示:短按造型灯亮度调节按钮,能够快速切换打开与关闭造型灯。

造型灯模式选择

- 1、短按菜单按键退出,显示Fn菜单。
- 2、按DIM多功能调节选择F4。
- 3、旋转DIM多功能调节选择模式。
ON:引闪时造型灯状态不变。
OFF:引闪时造型灯熄灭。
短按菜单按键退出。



声音提示

短按蜂鸣器按键实现打开或者关闭蜂鸣器,当LCD屏蜂鸣器符号显示时,表示蜂鸣提示音打开。LCD屏蜂鸣器符号不显示,表示蜂鸣提示音关闭。

当蜂鸣器开启:

- 1、每次回电充满时会响“BI--”一声,提示可以引闪。
- 2、按键与旋钮每次相应会响“BI--”一声。

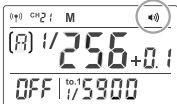

C.Fn: 设置自定义功能

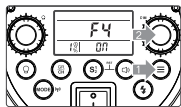

1 按菜单键,显示Fn菜单。

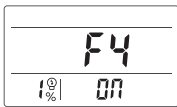

2 长按DIM多功能按钮选择Fn功能符号。

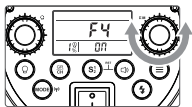

3 旋转DIM多功能按钮进行更改设置。短按菜单键按键退出。

自定义功能符号	功能	设置符号	设置和说明	使用范围限制
F1	闪光模式选择	ON	凝固(speed)模式	M/Multi模式
		OFF	色温恒定模式	
F2	延时闪光	OFF, 0.01~30S	可作为后帘引闪	M/Multi模式
F3	蒙板	OFF	蒙板功能关闭	M模式
		N1	蒙板功能开启; 触发2次为1个周期, 触发第1次引闪。	
		N2	蒙板功能开启; 触发2次为1个周期, 触发第2次引闪。	
F4	造型灯模式	ON	引闪时造型灯状态不变	无
		OFF	引闪时造型灯熄灭	
F5	无线ID	OFF	关闭	无线模式
		01-99	可选01-99任意数字	
F6	分数小数切换	1/P	闪光比显示为分数	无
		PP	闪光比显示为小数	

其他应用

记忆存储功能

闪光灯设有记忆设置功能, 设置完毕后三秒内未变更闪光灯会存储。下次开机使用时初始设置跟关机前一致。

装卸闪光灯管

关闭所有电源, 带上绝缘手套, 将闪光灯管往外拉出卸下旧灯管。新灯管对好灯管脚轻轻往里装, 推进卡到位后, 再装上玻璃罩。

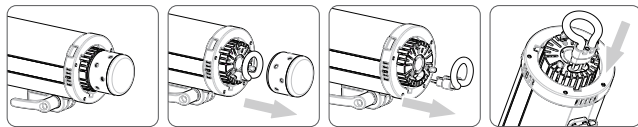

规格参数

型号	QT400IIM	QT600IIM	QT1200IIM	
闪光模式	M/Multi/Hss (高速同步)			
1/1 档闪光指数(ISO 100 以米为单位, 使用高亮反光罩)	65	76	105	
输入参数	100-240v~50/60Hz 8.0A			
闪光持续时间 (t0.1)	凝固(speed)模式	1/670 秒- 1/29600 秒	1/530 秒- 1/26100 秒	1/300 秒- 1/ 23400秒
	色温恒定模式	1/670 秒- 1/6700 秒	1/530 秒- 1/6010 秒	1/300 秒- 1/6090 秒
色温	色温恒定模式	5600±200K		
	凝固 (speed) 模式	5400K~9500K		
	高速同步闪光模式	4600K-5000K		
功率 POWER	400Ws	600Ws	1200Ws	
回电时间	约 0.01-0.9 秒			
档位范围	M	1/1 ~ 1/256		
	Hss	1/1 ~ 1/32		
	MULTI	1/4 ~ 1/256		
频闪闪光	具备(最大次数:99 次;最大频率:30)			
实现同步方式	高速同步(最高 1/8000 秒),前帘同步,后帘同步			
延时引闪	0.01-30 秒			
蒙板(MASK)	√			
风扇	√			
蜂鸣器	√			
LED造型灯	40W			
造型灯色温	4300K±200K			
LED造型灯调光范围	1% ~ 100%			
光控引闪	S1/S2			
显示闪光持续时间	√			
显示	高品质 LCD 液晶屏			
无线电 2.4G 传输(X 系统)				
无线功能	从属单元, ON/OFF			
可控制从属单元组	16 组 0~9, A, B, C, D, E, F			
传输范围(约)	50m			
频道	32 组: 1~32			
ID	01~99			
同步触发方式	内置 2.4G 无线传输			
工作环境温度	-10°C~50°C			
尺寸	392*176*143mm	392*176*143mm	460*176*143mm	
净重	2.96kg	3.33kg	4.26kg	

维护保养

闪光灯在工作时,如发现异常,应立即关掉电源,查明原因。

灯体应避免震动,平时注意表面除尘。

灯体稍有发热为正常现象,无特别需要时,勿连续引闪。

闪光灯的所有维修概由本厂指定可供原厂配件之维修部负责。

1年保修,消耗品如灯管等,不在1年保修范围。

如发现,擅自检修此闪光灯的,将取消闪光灯之一年保修期,维修需要收取相关费用。

如果本品出现故障或者被水淋湿,在专业人员维修后方可继续使用。

如有技术更改,恕不另行通知。

Foreword

Thank you for purchasing a GODOX product.

Thanks for choosing QTIII series high-speed flash. It has wide-range applicability, not only perfect for all kinds of studio and workshop photography, but also good at capturing fast-changing actions in a chain of pictures in highspeed continuous shooting, e.g. action photography, stage photography, sports photography, scientific photography, etc. In addition, in fashion or portrait photography, photographers can capture a series of fast-changing facial expressions and amazing moves, and clearly freeze each fleetingly perfect instant into eternal beauty. Among the benefits you'll enjoy:

- Ultra-speedy charging, 0.01-0.9s recycling time
- Achieving 1/8000s high-speed sync
- Up to 10 shots in one second under high-speed continuous shooting
- Exact output control on LCD panel from 1/256 to 1/1
- 40W LED modeling lamp supports stepless brightness adjustment
- Outstanding output stability, less than 2% shifts when under the same output
- High color stability, ranging within $\pm 200k$ (stable mode) between flashes over the entire power range
- Built-in X1 system (2.4G transmission)
- S1/S2 Receiver Mode
- Delay function
- Mask function
- High qualified LCD panel

Warning

Please read the following warnings in their entirety before using this product.

Keep these safety instructions where users can read them for ready reference.

- ⚠ Do not disassemble or modify. Should the product break down, send the defective back to the authorized service center for inspection and maintenance.
- ⚠ Keep dry. Do not handle with wet hands, immerse in water, or expose to rain.
- ⚠ Keep out of reach of children.
- ⚠ Please put the device in a ventilation environment and keep the parts of lighting and heat dissipation holes are unobstructed. Do not use in flammable environment.
- ⚠ As this product adopts make and break device, please keep it easy to be used.
- ⚠ No touching the heating parts of this product.
- ⚠ Please turn off the power and wear insulated gloves before installing and connecting accessories. When replacing the tube or modeling lamp, please make sure that the tube is cool and wear insulated gloves to prevent burns.
- ⚠ Do not flash directly towards naked eyes (especially those of babies), otherwise it may lead to visual impairment.
- ⚠ Disconnect from the power supply when it will not be used for an extended period.

Caution

- ⚠ After 30 continuous flashes at full power, the flash should be cooled down for about 3 minutes. Overheating will occur if it is used continuously without cooling down.
- ⚠ Do not keep using the modeling lamp for a long time; otherwise flammable accessories attaching to flash head, e.g. softbox will get burnt. A 10-minute time is recommended in this case. After 10 minutes, cool it down for 1 minute.
- ⚠ When using a snoot, do not keep the modeling lamp on for a long time or fire too frequently (not over six times for one minute). Overheating will result in damages for strobe housing and/or studio light.
- ⚠ Avoid sudden impacts as this can damage the flash tube and/or modeling lamp.

Avertissement

- ⚠ Veuillez lire attentivement les avertissements suivants avant d'utiliser cet équipement et conservez-les dans un endroit sûr afin que tous les utilisateurs de ce produit puissent s'y référer à tout moment.
- ⚠ Ne démontez pas le produit vous-même. Si le produit est défectueux, il doit être inspecté et réparé par notre société ou par un personnel de service agréé.
- ⚠ Garder au sec : ne pas toucher le produit avec des mains mouillées, ni l'immerger dans l'eau ou l'exposer à la pluie.
- ⚠ Ne laissez pas les enfants entrer en contact avec ce produit.
- ⚠ Le flash est adapté à une utilisation dans un environnement ventilé, veuillez garder la source de lumière et le dissipateur thermique non bloqués lors de l'utilisation. Ne pas utiliser dans des atmosphères inflammables ou explosives.
- ⚠ Le flash utilise la fiche secteur comme dispositif de déconnexion et doit rester facilement accessible à tout moment.
- ⚠ Ne touchez pas les parties chaudes de la lampe avec vos mains pendant l'utilisation.
- ⚠ Lors de l'installation et de la connexion d'accessoires, éteignez l'interrupteur et débranchez l'alimentation électrique. Lors du chargement ou du déchargement du tube flash/de la lampe pilote, assurez-vous que le tube est refroidi pour éviter les brûlures et portez des gants isolants.
- ⚠ Ne faites pas passer la tête du flash devant l'œil humain (en particulier dans les yeux des enfants en bas âge), car cela pourrait entraîner une déficience visuelle de courte durée.
- ⚠ Lorsqu'il n'est pas utilisé, débranchez-le de l'alimentation électrique.

Précautions à prendre

- ⚠ Après 30 flashes consécutifs à pleine puissance, le flash doit refroidir pendant environ 3 minutes. Si la lampe est utilisée en continu sans être refroidie, la chaleur s'accumule.
- ⚠ N'utilisez pas la lampe pilote en continu pendant de longues périodes, car cela pourrait faire brûler des accessoires inflammables tels que les boîtes à lumière montées sur la tête de la lampe. Il est recommandé de ne pas utiliser la lampe pilote en continu pendant plus de 10 minutes en présence d'accessoires inflammables. Si vous l'utilisez pendant plus de 10 minutes, laissez-le refroidir pendant 1 minute avant de le réutiliser.
- ⚠ Lorsque vous utilisez le faisceau, ne laissez pas la lampe pilote allumée pendant de longues périodes et ne faites pas clignoter la lampe trop souvent (pas plus de 6 fois par minute à pleine puissance). L'accumulation de chaleur peut endommager le boîtier du flash ou endommager la lampe.
- ⚠ Évitez les chocs soudains pour ne pas endommager le tube flash ou la lampe de mise au point.

Contents

17	Foreword
18	Warning
18	Caution
23	Names of Parts
	Body
	LCD Panel
	Accessories
	Separately Sold Accessories
25	Operations
	Flash Preparation
28	M: Manual Flash
	Stable Color Temperature Mode and High-Speed
	Flash (speed) Mode
29	⚡ High-Speed Sync
31	Multi: Stroboscopic Flash
31	Wireless Flash Shooting: Radio (2.4G) Transmission
	Wireless Settings
	Setting the Communication Channel
	Setting the Communication Group
33	Receiver Model
34	Modeling Lamp
35	Buzz Function
36	C.Fn: Setting Custom Function
37	Other Applications
	Memory Function
	Tube Replacement
38	Technical Data
39	Maintenance

Conventions used in this Manual

- This manual is based on the assumption that both the camera and camera flash's power switches are powered on.
- Reference page numbers are indicated by "p.**".
- The following alert symbols are used in this manual:
 - ▲ The Caution symbol indicates a warning to prevent shooting problem.
 - The Note symbol gives supplemental information.

Name of Parts

Body:

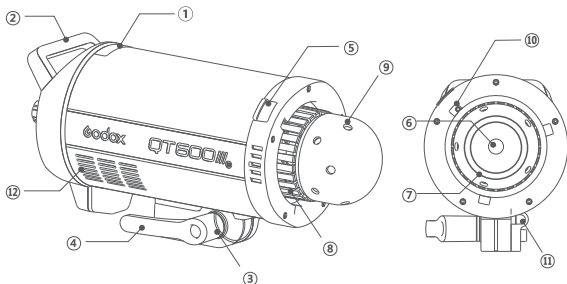

- ① Light Sensor
- ② Handle
- ③ Bracket
- ④ Direction Adjusting Handle
- ⑤ Lampshade Button
- ⑥ LED Modeling Lamp
- ⑦ Light Tube
- ⑧ Ventilation
- ⑨ Glass Lampshade
- ⑩ Bowen Mount
- ⑪ Umbrellas Input

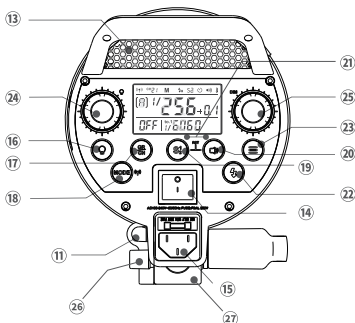

- ⑬ Power Switch
- ⑭ Power Socket
- ⑮ Modeling Button
- ⑯ GR/CH Button
- ⑰ MODE/Wireless Button
- ⑱ S1/S2 Button
- ⑲ Beep Button
- ⑲ RST(S1/S2+Beep) Combined Button
- ⑳ Flash Button
- ㉑ Menu Button
- ㉒ Modeling Adjustment Button
- ㉓ DIM Select Dial
- ㉔ Locking Dial
- ㉕ Sleeve

Name of Parts

LCD Panel:

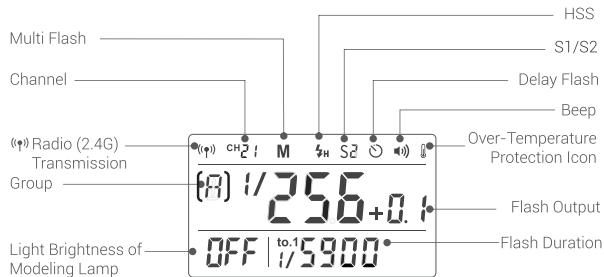

Accessories



Separately Sold Accessories

The product can be used in combination with the following accessories sold separately, so as to achieve best photography effects: flash triggers and camera flashes with 2.4G wireless TX functions, Power Inverter, Softbox, Photographic Umbrella, Light Stand, Barndoor, Beauty Dish, Snoot, etc.

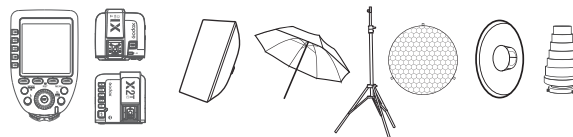

Operations

Flash Preparation

1. Take down the lamp cover, install the light tube and put on the glass protection cover.

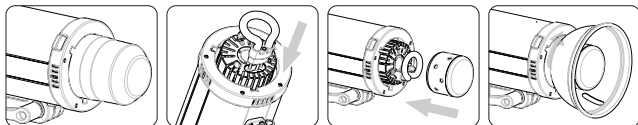

2. Attach the flash unit on an appropriate light stand. Adjust the mounting bracket for a good angle and make sure it's tightened and fixed. Use the direction adjusting handle to adjust the flash on a desired direction. Umbrella input is for different photo umbrellas to put in.

M: Manual Flash

The flash output is adjustable from 1/1 full power to 1/256th power in 1/10 stop increments. To obtain a correct flash exposure, use a hand-held flash meter to determine the required flash output.



1 Press <MODE> button so that <M> is displayed.



1 Turn the DIM Select Dial to choose a desired flash output amount.

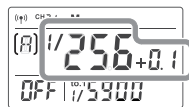

Display Flash Duration

Flash duration refers to the length of time that from flash's firing to reach the half peak at maximum. The half peak at maximum is usually expressed as $t=0.5$. In order to provide the photographer with more concrete data, this product adopts $t=0.1$. The difference between $t=0.5$ and $t=0.1$ is shown in the following picture.

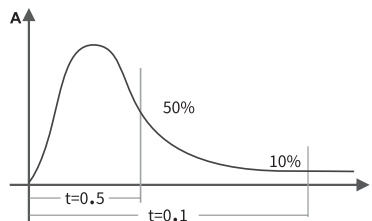

Stable Color Temperature Mode:
enter MENU C.Fn-F1 and set it as OFF, which means the color temperature mode is turned on, the color temperature changes within $\pm 200K$ over the entire power range.

Flash duration will only be displayed in the M mode.

When adjusting the power output from high to low in this mode, Flash Ready Indicator will blink (the beeper will alarm). Now press the Test Button to discharge, and the flash can be used as normal.

Stable Color Temperature Mode and High-Speed Flash (speed) Mode

Stable Color Temperature Mode or High-Speed Flash (speed) Mode can be chosen in the C.Fn-F1 setting. These two modes are effective in M/Multi mode and ineffective in high-speed sync mode.

Stable Color Temperature Mode default: color temperature ranges within $\pm 200K$, which is a good choice for the photographers who pursues stable color temperature.

High-Speed Flash (speed) Mode: the max flash duration is up to $t0.1=1/26100$, which is perfect for capturing the fast-changing actions. As the color temperature is a little higher in this mode, please set the camera's white balance parameter to the proportional color temperature amount (see the chart below) or AWB (Auto White Balance).

QT600IIIM					
Test Environment	Darkroom				
Color Temperature Test	Equipment	SEKONIC C-800			
	Testing Method	Trigger beyond 1 meters and average the amount of 3 tests.			
Flash Duration (t0.1)	IGBT control the time of turning on the flash				
Stable Color Temperature Mode			High-Speed Flash (speed) Mode		
Parameter Level	Color Temperature CCT(K)	Flash Duration t0.1(S)	Parameter Level	Color Temperature CCT(K)	Flash Duration t0.1(S)
1/256	5734	1/6010	1/256	8378	1/26100
1/256+0.3	5760	1/5560	1/256+0.3	8471	1/25800
1/256+0.7	5745	1/5420	1/256+0.7	8024	1/24700
1/128	5729	1/5170	1/128	9335	1/24100
1/128+0.3	5718	1/4940	1/128+0.3	9108	1/23400
1/128+0.7	5686	1/4830	1/128+0.7	9010	1/19300
1/64	5619	1/4680	1/64	8535	1/16500
1/64+0.3	5635	1/4400	1/64+0.3	8205	1/13900
1/64+0.7	5657	1/3970	1/64+0.7	7698	1/12700
1/32	5630	1/3700	1/32	7367	1/11400
1/32+0.3	5639	1/3530	1/32+0.3	7151	1/10300
1/32+0.7	5608	1/3110	1/32+0.7	6856	1/9500
1/16	5620	1/2940	1/16	6579	1/8700
1/16+0.3	5647	1/2760	1/16+0.3	6440	1/7800
1/16+0.7	5657	1/2360	1/16+0.7	6216	1/6700
1/8	5677	1/2090	1/8	6126	1/5700
1/8+0.3	5674	1/1920	1/8+0.3	6072	1/5000
1/8+0.7	5610	1/1670	1/8+0.7	5954	1/4100
1/4	5568	1/1400	1/4	5907	1/3500
1/4+0.3	5566	1/1250	1/4+0.3	5867	1/3000
1/4+0.7	5556	1/1060	1/4+0.7	5837	1/2200
1/2	5646	1/900	1/2	5844	1/1600
1/2+0.3	5681	1/770	1/2+0.3	5738	1/1200
1/2+0.7	5649	1/590	1/2+0.7	5636	1/690
1/1	5549	1/530	1/1	5539	1/530

High-Speed Sync

In this mode, you can set the flash output from 1/1 full power to 1/32nd power in 1/10 stop increments.

High Speed Sync enables the flash to synchronize with all camera shutter speeds. This is convenient when you want to use aperture priority for fill-flash portraits.

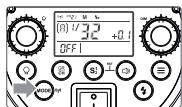

1 Press the <MODE> Button so that <High-Speed Sync> is displayed.

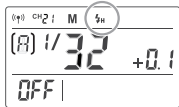

2 Turn the DIM Select Dial to set the flash output power.



3 Please use the transmitter of X1 series (optional).

- With high-speed sync, the faster the shutter speed, the shorter the effective flash range.
- Multi flash mode cannot be set in high-speed sync mode.
- With high-speed sync, the color temperature is lower (decrease around 700K) because of tube's characteristics. Please set the camera to AWB (Auto White Balance).

Multi: Stroboscopic Flash

In this mode, you can set the flash output from 1/4th power to 1/256th power in 1 stop increments. With stroboscopic flash, a rapid series of flashes is fired. It can be used to capture a multiple images of a moving subject in a single photograph. You can set the firing frequency (number of flashes per sec. expressed as Hz), the number of flashes, and the flash output.

Multi: Stroboscopic Flash

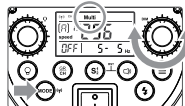

1 Press <MODE> button so that <Multi> is displayed.

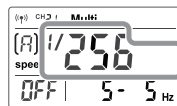

2 Turn the DIM Select Dial to choose a desired flash output.

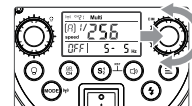

3 Set the flash frequency and flash times.

- Press DIM Select Dial to select the flash times. Turn the DIM Select Dial to set the number.
- Press DIM Select Dial to select the flash frequency. Turn the DIM Select Dial to set the number.

Calculating the Shutter Speed

During stroboscopic flash, the shutter remains open until the firing stops. Use the formula below to calculate the shutter speed and set it with the camera.

$$\text{Number of Flashes / Flash Frequency} = \text{Shutter Speed}$$

For example, if the number of flashes is 10 and the firing frequency is 5 Hz, the shutter speed should be at least 2 seconds.

- Stroboscopic flash is most effective with a highly reflective subject against a dark background.
- Using a tripod and a remote control is recommended.
- A flash output of 1/1 and 1/2 cannot be set for stroboscopic flash.
- If the number of flashes is displayed as "--", the firing will continue until the shutter closes is exhausted. The number of flashes will be limited as shown by the following table.

Multi: Stroboscopic Flash

Maximum Stroboscopic Flashes:

Flash Output \ Hz	1	2	3	4	5	6-7	8-9	10	11	12-14	15-19	20-30
1/4	7	6	5	4	4	3	3	2	2	2	2	2
1/8	7	6	5	4	4	3	3	2	2	2	2	2
1/16	14	14	12	10	8	6	5	4	4	4	4	4
1/32	30	30	30	20	20	20	10	8	8	8	8	8
1/64	60	60	60	50	50	40	30	20	20	20	18	16
1/128	99	99	90	80	80	70	60	50	40	40	35	30
1/256	99	99	90	80	80	70	60	50	40	40	35	30

Wireless Flash Shooting: Radio (2.4G) Transmission

QTIll adopts built-in 2.4G wireless X system, which is perfectly compatible with other products of our company.

Nikon cameras (using X1T-N, TT685N, etc.) and Canon cameras (using X1T-C, TT685C, etc.) can enjoy one or more QTIll together.

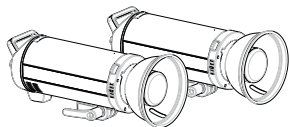

* As a receiver unit, QTIll can be controlled by the transmitter unit e.g.

AD360II-C, AD360II-N, TT685 series, V860II series, V1 series, XPro series, X2T series, X1T series, TT600, etc.

Wireless Flash Shooting: Radio (2.4G) Transmission

Wireless Settings

Press <GR/CH> Wireless Button so that <CH> is displayed, entering the 2.4G wireless status now.

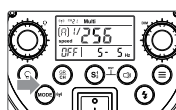

Setting the Communication Channel

If there are other wireless flash systems nearby, you can change the channel IDs to prevent signal interference. The channel IDs of the transmitter unit and the receiver unit(s) must be set to the same.

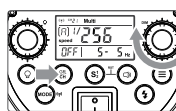

1 Long press the <GR/CH> Button for 2 seconds until the channel IDs is blinking.

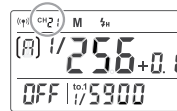

2 Turn the DIM Select Dial to choose the channel from 1 to 32.

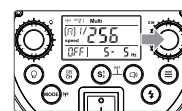

3 Press the DIM Select Dial to confirm.

Setting the Communication Group

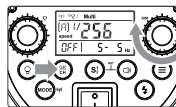

1 Short press the <GR/CH> Button for 2 seconds until the group IDs is blinking.

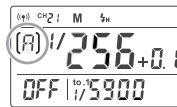

2 Turn the DIM Select Dial to choose the channel from 1 to F.

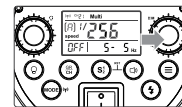

3 Press the DIM Select Dial to confirm.

Receiver Model

Optical S1 Secondary Unit Setting

In M manual flash mode, press <S1/S2> button so that this flash can function as an Optical S1 secondary flash with Optical sensor. With this function, the flash will fire synchronously when the main flash fires, the same effect as that by the use of radio triggers. This helps create multiple lighting effects.

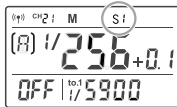
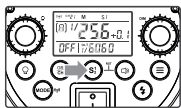

Optical S2 Secondary Unit Setting

Press <S1/S2> button so that this flash can also function as an Optical S2 secondary flash with Optical sensor in M manual flash mode. This is useful when cameras have pre-flash function. With this function, the flash will ignore a single "pre-flash" from the main flash and will only fire in response to the second, actual flash from the main unit.

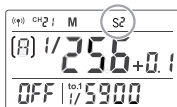
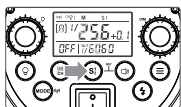

Modeling Lamp

QTIII has a 40W LED modeling lamp whose brightness can be steplessly adjusted.

· Short press the Modeling Lamp Button to choose the modeling lamp's mode from OFF, Percentage and PROP.

OFF : OFF : Modeling lamp is off.

1% Percentage : Adjust the modeling lamp's light brightness manually from 1% to 100%.

PROP PROP : The modeling lamp's power changes with the flash's power.

The bigger power the flash has, the brighter the modeling lamp is.

urn the Modeling Adjustment Button to choose the brightness from 1% to 100%.

· Tips: Short press the Modeling Adjustment Button can quickly turn on/off the modeling lamp.

· Choose the Modeling Lamp's Modes

1. Short press the MENU Button until Fn menu is displayed.

2. Press the DIM Select Dial to choose F4.

3. Turn the DIM Select Dial to choose the Modes:

ON: the modeling lamp will keep this status when triggering;

OFF : the modeling lamp will turn off when triggering;

Short press the MENU Button to exit.

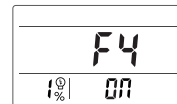

Buzz Function

Short press the Buzz Button to turn on/off the Beeper. When the buzz indicator is displayed on the LCD panel, it means the sound reminder is turned on; if not displayed, the sound reminder is turned off.

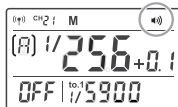

When Buzz function is turned on

1. The "BI" beep will be heard when it's fully charged.
2. The "BI" beep will be heard when operate the buttons or select dials.

C.Fn: Setting Custom Function

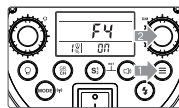

- 1 Press the Menu Button until <Fn> menu is displayed.



- 2 Press the DIM Select Dial to choose Fn function signs.

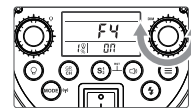

- 3 Turn the DIM Select Dial to change the settings. Short press the MENU button to exit.

Custom Function Signs	Function	Setting No.	Settings & Description	Restrictions
F1	Choose mode flash	ON	High-Speed Flash (speed) Mode	M/Multi mode
		OFF	Stable Color Temperature	
F2	Delay flash	OFF,0.01~30S	Trigger as second curtain	M/Multi mode
F3	Mask function	OFF	Mask function is off	M mode
		N1	Mask function is on: when setting 2 times triggering as a period, the first triggering will fire a flash.	
		N2	Mask function is on: when setting 2 times triggering as a period, the second triggering will fire a flash.	
F4	Modeling lamp mode	ON	The modeling lamp will not change its status when triggering.	No
		OFF	The modeling lamp will turn off when triggering.	
F5	Wireless ID	OFF	OFF	Wireless mode
		01-99	Choose any figure from 01 to 99	
F6	Switth between fraction and decimal	1/P	Flash ratio displays in fraction	No
		PP	Flash ratio displays in decimal	

Other Applications

Memory Function

The device is equipped with memory function for the panel setting. It will help remember the panel setting 3 second after you set it. When starting up the flash next time, the panel setting will be the same as the status before powering it off.

Tube Replacement

Shut down the power and remove the power cord before replacing the flash tube and wear insulated gloves. Then, pull out the old tube gently. Hold two feet of the new tube, and target directly towards the two copper outlets, then push them slightly in. Put on the glass protection cover after the tube is correctly installed.

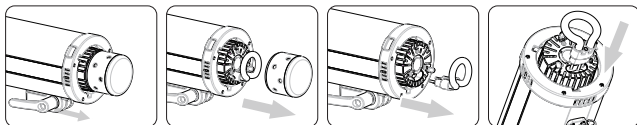

Warning

Operating frequency :2412.99MHz – 2464.49MHz (only receive)

Declaration of Conformity

GODOX Photo Equipment Co.,Ltd. hereby declares that this equipment are in compliance with the essential requirements and other relevant provisions of Directive 2014/53/EU.

In accordance with Article 10(2) and Article 10(10), this product is allowed to be used in all EU member states.

For more information of DoC, Please click this web link:

https://www.godox.com/DOC/Godox_QTIIIIM_Series_DOC.pdf.

The device complies with RF specifications when the device used at 0mm from your body.

Technical Data

Model	QT400IIIIM	QT600IIIIM	QT1200IIIIM	
Flash Mode	M/Multi/Hss(high-speed sync)			
Guide Number in 1/1 full power(m ISO 100,using highlight reflector)	65	76	105	
Input Parameter	100-240v~50/60Hz 8.0A			
Flash Duration (t0.1)	High-Speed Flash (speed) Mode	1/670 s- 1/29600s	1/530 s- 1/26100 s	1/300 s-1/ 23400s
	Stable Color Temperature Mode	1/670 s- 1/6700 s	1/530 s- 1/6010 s	1/300 s- 1/6090 s
Color Temperature	Stable Color Temperature Mode	5600±200K		
	High-Speed Flash (speed) Mode	5400K~9500K		
	High-Speed Sync Flash (speed) Mode	4600K~5000K		
Power	400Ws	600Ws	1200Ws	
Recycle Time	Approx. 0.01-0.9 s			
Output Level	M	1/1~1/256		
	Hss	1/1~1/32		
	Multi	1/4-1/256		
Multi Flash	Yes (max. flash time:99; max. flash frequency: 30)			
Sync Mode	High-speed sync (up to 1/8000s), first curtain sync, second curtain sync			
Delay Flash	0.01~30 秒			
MASK Function	✓			
Fan	✓			
Beeper	✓			
LED Modeling Lamp	40W			
Modeling Light Color Temperature	4300K±200K			
Brightness Adjustment Range of Modeling Lamp	1%~100%			
Receiver Model	S1/S2			
Display Flash Duration	✓			
Display	High qualified LCD panel			
• Radio (2.4G) Transmission (X system)				
Wireless Function	Receiver unit, ON/OFF			
Controllable Receiver units	16 groups: 0~9 ,A,B,C,D,E,F			
Transmission Range (approx.)	50m			
Channel	32:1~32			
ID	01-99			
Sync Triggering Mode	Built-in 2.4G wireless transmission			
Working Environment Temperature	-10°C~50°C			
Dimension	392*176*143mm	392*176*143mm	460*176*143mm	
Net Weight	2.96kg	3.33kg	4.26kg	

Maintenance

- Shut down the device immediately when it works abnormally and find out the reason.
- Avoid sudden impacts and the lamp should be dedusted usually.
- It's normal for lamp being warm when in use. Avoid continuous flashes when it is not necessary.
- Maintenance of all the flashes is up to our authorized maintenance department which can provide original accessories. Users can replace the flash tube and modeling lamp provided by the manufacturer.
- One year warranty period will be cancelled when any unauthorized maintenance is found.
- If the product had failures or was wetted, it can be continuously used only after it is repaired by professionals.
- Disconnect the power when doing maintenance work or cleaning.
- New changes made to the specifications or designs may not be updated in this manual.

Warning

Operating frequency:2412.99MHz – 2464.49MHz (only receive)

Declaration of Conformity

GODOX Photo Equipment Co.,Ltd. hereby declares that this equipment are in compliance with the essential requirements and other relevant provisions of Directive 2014/53/EU. In accordance with Article 10(2) and Article 10(10), this product is allowed to be used in all EU member states.For more information of DoC, Please click this web link:

https://www.godox.com/DOC/Godox_QTIIIM_Series_DOC.pdf

The device complies with RF specifications when the device used at 0mm from your body,

FCC Statement

This device complies with part 15 of the FCC Rules. Operation is subject to the following two conditions: (1) This device may not cause harmful interference, and (2) this device must accept any interference received, including interference that may cause undesired operation.

Any Changes or modifications not expressly approved by the party responsible for compliance could void the user's authority to operate the equipment.

Note: This equipment has been tested and found to comply with the limits for a Class B digital device, pursuant to part 15 of the FCC Rules. These limits are designed to provide reasonable protection against harmful interference in a residential installation. This equipment generates uses and can radiate radio frequency energy and, if not installed and used in accordance with the instructions, may cause harmful interference to radio communications. However, there is no guarantee that interference will not occur in a particular installation. If this equipment does cause harmful interference to radio or television reception, which can be determined by turning the equipment off and on, the user is encouraged to try to correct the interference by one or more of the following measures:

- Reorient or relocate the receiving antenna.
- Increase the separation between the equipment and receiver.
- Connect the equipment into an outlet on a circuit different from that to which the receiver is connected.
- Consult the dealer or an experienced radio/TV technician for help.

The device has been evaluated to meet general RF exposure requirement.

The device can be used in portable exposure condition without restriction.

产品保修

尊敬的用户，本保修卡是申请保修服务的重要凭证，请您配合销售商填写并妥善保管，谢谢！

产品信息	型号	产品条码
用户信息	姓名	联系电话
	通信地址	
销售商信息	名称	
	联系电话	
	通信地址	
	销售日期	
备注		

注：此表应由销售商盖章确认。

适用产品

本文件适用于相关《产品保修信息》(见后面说明)所列产品，其他非属此范围的产品或部件(如促销品、赠品及其他出厂后附加的部件等)不在此保修承诺内。

保修期

产品及部件的相应保修期按相关的《产品保修信息》执行。保修期自产品首次购买日起算，购买日以购买产品时保修卡登记日期为准。

如何获得保修服务

要保修服务，您可直接与产品销售商或授权服务机构联系，也可拨打神牛产品售后服务电话，与我们联系，由我们的服务人员为您安排服务。申请保修时，您应提供有效的保修卡作为保修凭证，方可获得保修。如您不能提供有效的保修卡，则在我们可确认产品或部件属于保修范围的情况下，也可以为您提供保修，但这不作为我们的义务。

不适用保修的情况

如产品存在下列情况，本文件项下的保证和服务将不适用 ①产品或部件超过相应保修期；②错误或不当使用、维护或保管导致的故障或损坏，如：不当搬运；非按产品合理预期用途使用；不当插拔外接设备；跌落或外力挤压；接触或暴露于不适当温度、溶剂、酸碱、水浸或潮湿环境；③由非神牛授权机构或人员安装、修理、更改、添加或拆卸造成的故障或损坏；④产品或部件原有识别信息被修改变更或删除；⑤无有效保修卡；⑥使用非法授权、非标准或非公开发行的软件造成的故障或损坏；⑦因不可抗力或意外事件造成的故障或损坏；⑧其他非因产品本身质量问题导致的故障或损坏。遇上述情况，您应向相关责任方寻求解决，神牛对此不承担任何责任。因非在保修期或保修范围内的部件、附件或软件导致产品不能正常使用的，不是保修范围内的故障。产品使用过程中正常的脱色、磨损和消耗，不是保修范围内的故障。

产品保修和服务支持信息

产品的保修期和服务类型按以下《产品保修信息》执行：

产品类别	选件名称	保修期(月)	保修服务类型
部件	电路板	12	客户送修
	电池	3	客户送修
	充电器等带电性能的部件。	12	客户送修
其他	如闪光管、造型灯泡、外壳、保护罩、锁紧装置、包装等。	无	无保修

神牛产品售后服务电话 0755-29609320-8062

Warranty

Dear customers, as this warranty card is an important certificate to apply for our maintenance service, please fill in the following form in coordination with the seller and safe-keep it. Thank you!

Product Information	Model	Product Code Number
Customer Information	Name	Contact Number
	Address	
Seller Information	Name	
	Contact Number	
	Address	
	Date of Sale	
Note:		

Note: This form shall be sealed by the seller.

Applicable Products

The document applies to the products listed on the Product Maintenance Information (see below for further information). Other products or accessories (e.g. promotional items, giveaways and additional accessories attached, etc.) are not included in this warranty scope.

Warranty Period

The warranty period of products and accessories is implemented according to the relevant Product Maintenance Information. The warranty period is calculated from the day (purchase date) when the product is bought for the first time. And the purchase date is considered as the date registered on the warranty card when buying the product.

How to Get the Maintenance Service

If maintenance service is needed, you can directly contact the product distributor or authorized service institutions. You can also contact the Godox after-sale service call and we will offer you service. When applying for maintenance service, you should provide valid warranty card. If you cannot provide valid warranty card, we may offer you maintenance service once confirmed that the product or accessory is involved in the maintenance scope, but that shall not be considered as our obligation.

Inapplicable Cases

The guarantee and service offered by this document are not applicable in the following cases:
①. The product or accessory has expired its warranty period;
②. Breakage or damage caused by inappropriate usage, maintenance or preservation, such as improper packing, improper usage, improper plugging in/out external equipment, falling off or squeezing by external force, contacting or exposing to the improper temperature, solvent, acid, base, flooding and damp environments, etc;
③. Breakage or damage caused by non-authorized institution or staff in the process of installation, maintenance, alternation, addition and detachment;
④. The original identifying information of product or accessory is modified, alternated, or removed;
⑤. No valid warranty card;
⑥. Breakage or damage caused by using illegally authorized, nonstandard or non-public released software;
⑦. Breakage or damage caused by force majeure or accident;
⑧. Breakage or damage that could not be attributed to the product itself.
Once met these situations above, you should seek solutions from the related responsible parties and Godox assumes no responsibility. The damage caused by parts, accessories and software that beyond the warranty period or scope is not included in our maintenance scope. The normal discoloration, abrasion and consumption are not the breakage within the maintenance scope.

Maintenance and Service Support Information

The warranty period and service types of products are implemented according to the following **Product Maintenance Information**:

Product Type	Name	Maintenance Period(month)	Warranty Service Type
Parts	Circuit Board	12	Customer sends the product to designated site
	Battery	3	Customer sends the product to designated site
	Electrical parts e.g. battery charger, etc.	12	Customer sends the product to designated site
Other Items	Flash tube, modeling lamp, lamp body, lamp cover, locking device, package, etc.	No	Without warranty

Godox After-sale Service Call **0755-29609320-8062**