

Godox

AD300Pro

外拍灯 | Outdoor Flash



深圳市神牛摄影器材有限公司
GODOX Photo Equipment Co., Ltd.

地址/Add: 深圳市宝安区福海街道塘尾社区耀川工业区厂房2栋
Building 2, Yaochuan Industrial Zone, Tangwei Community, Fuhai Street, Bao'an District, Shenzhen, China
电话/Tel: +86-755-29609320(8062) 传真/Fax: +86-755-25723423
邮箱/E-mail: godox@godox.com <http://www.godox.com>
705-AD30P0-00 Made In China



使用手册

INSTRUCTION MANUAL

前言

在使用本产品之前

请先仔细阅读本手册，以确保您能安全使用。

请保存好本手册以备将来查询参考。

感谢您购买神牛产品。

口袋灯AD300Pro功率强劲，小巧机身，方便携带。大容量锂电池与机身一体，可更换不同卡口安装各类光效附件。全面支持各品牌相机TTL。便携与高效光质兼具，实为自由商业摄影师、新闻记者、发烧友、摄影爱好者、婚纱纪实摄影师等的理想光源。

产品有以下亮点：

无线TTL系统全面兼容：采用内置神牛2.4G无线X系统，支持Canon、Nikon、Sony、Fuji、Olympus、Panasonic和Pentax相机TTL/M/Multi等功能；可作为无线多灯闪光系统的从属单元，拍摄简单快捷。

功率强大，小巧便携：闪光灯功率高达300Ws。

高品质VA显示屏：显示直观，操作更加简易

内置2.4G无线传输：100米超远距离，创意无限

专业电源：使用国际品牌电池，大容量电源盒(14.4V/2600mAh)，0.01-1.5s回电，全光320次左右

无线操控：内置使用神牛2.4G无线X系统，可实现TTL控制，外置可使用神牛FT-16遥控器，可无线控制闪光灯功率大小等，并同步触发引闪；同时留有3.5mm同步插孔，可实现多种同步触发方式。

调光精准：功率调节范围大（1/1-1/256），81级精确微调，光效把握更随心。

色温恒定：全程档位波动±100K范围内（色温恒定模式）

高级功能：支持1/8000秒高速同步，高速频闪，高速遥控器同步触发等。

警告

- ▲ 请保持干燥。
- ▲ 请勿私自拆卸产品，如产品出现故障须由本公司或授权的维修人员进行检查维修。
- ▲ 请勿让儿童接触本产品。
- ▲ 禁止拆卸、撞击、挤压或投入火中，若出现严重鼓胀，请勿继续使用。请勿放置在超过50度的高温环境中。
- ▲ 请勿将闪光灯头正对人眼闪光(特别是婴儿的眼睛)，否则可能会在短时间内造成视力障碍。
- ▲ 请勿在化学品、可燃性气体或其他特殊物质附近使用闪光灯，这些物质在特殊情况下可能对闪光灯发出的瞬间强光敏感，有可能导致火灾或电磁干扰。在这些场合下，请注意相关警告标识。
- ▲ 本产品不能防水，在雨天及潮湿环境下请注意防水。
- ▲ 若发生任何故障，请立即关闭闪光灯电源。

目录

01	前言
02	警告
05	部件名称
	机身
	VA显示屏
	标配物品
	可选购附件
	如何装卸其他卡口卡盘及安装附件
	如何装卸闪光灯管
10	电池
10	电源管理
11	造型灯
11	无线模式选择
12	闪光模式-- TTL自动闪光模式
	TTL模式
	 高速同步
12	闪光模式-- M: 手动闪光
14	闪光模式-- Multi: 频闪闪光
15	无线传输闪光: 无线电(2.4G)传输
17	C.Fn: 设置自定义功能
18	其他应用
	变焦功能
	同步插孔触发
18	保护功能
19	规格参数
20	固件升级
20	维护保养

本说明书中使用的约定

- 此使用说明书中的操作步骤假定相机和闪光灯的电源开关已开启。
- 参考页码由(第**页)表示。
- 此使用说明书中使用以下警告符号:
 - ▲ 该“小心”符号表示避免出现拍摄问题的警告。
 - 该“注意”符号提供补充信息。

部件名称

机身：

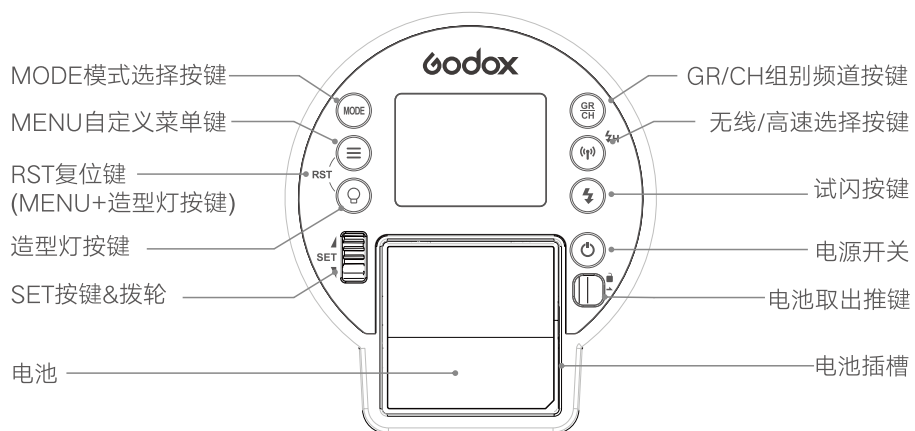
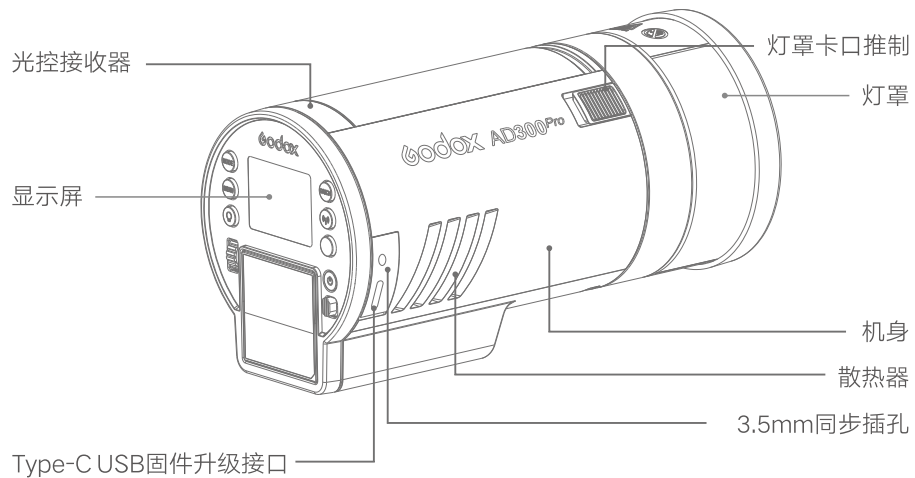

部件名称

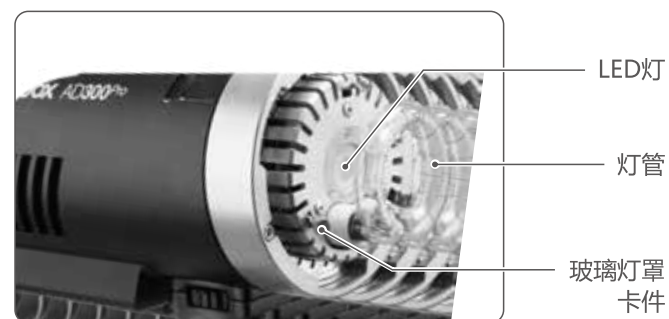
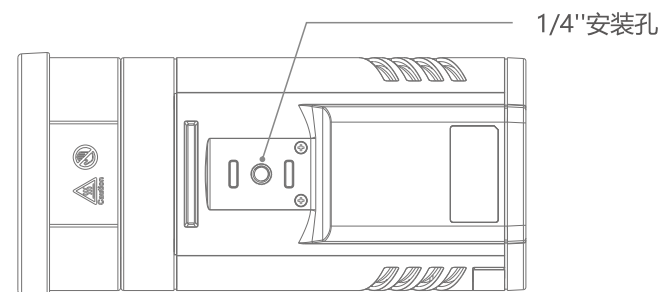

部件名称

VA显示屏

(1)显示屏

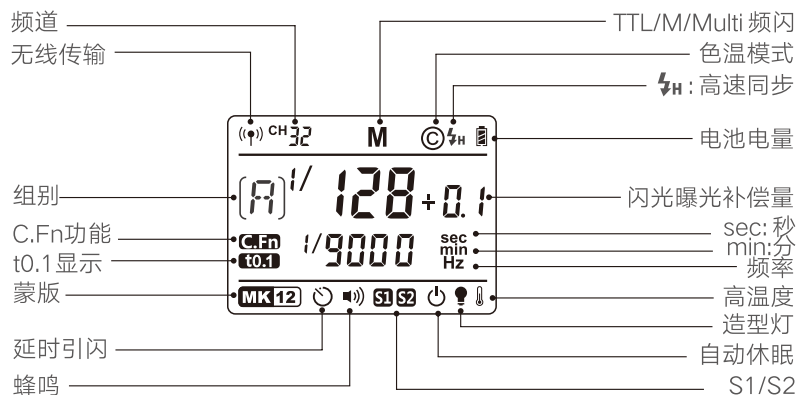

- 显示屏将只显示当前应用的设置。
- 当操作按钮或拨盘时，液晶显示屏点亮。

(2)M手动闪光

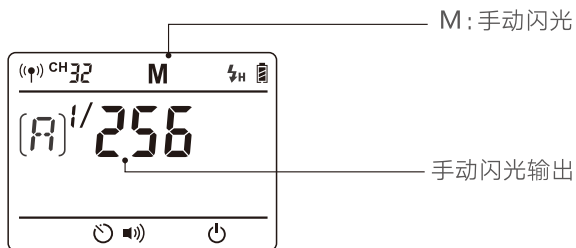

(3)Multi频闪闪光

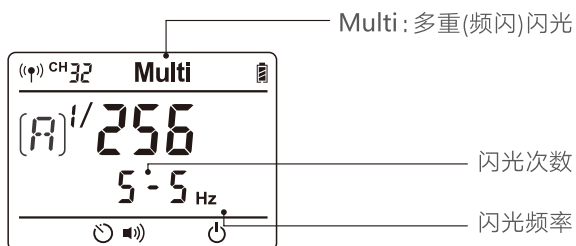

部件名称

(4)无线电传输拍摄

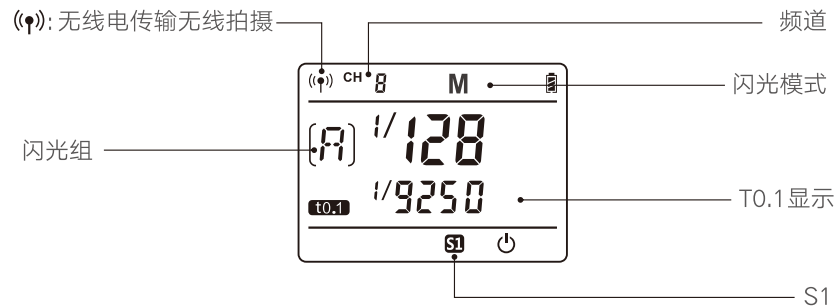

• S1/S2

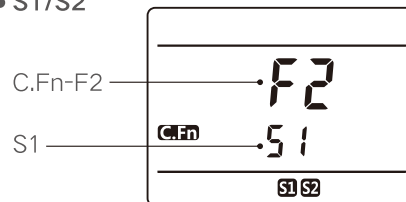

• CCT

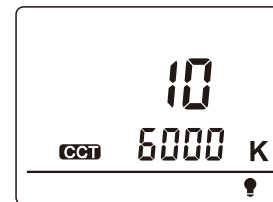

标配物品

- 1、机身
- 2、灯管
- 3、玻璃灯罩
- 4、反光罩
- 5、AD-E2支架
- 6、电池
- 7、充电器
- 8、便携包
- 9、说明书



可选购附件

可搭配本公司以下摄影附件使用，以获得最佳的拍摄效果和使用体验：
XPro、X2、X1系列发射器、卡盘转接座、保荣/爱玲珑/高明卡口卡盘、柔光箱、雷达罩、
折叠柔光伞、束光筒、灯架等。



部件名称

如何更换其他卡口卡盘及安装附件



1 拨动灯罩固定拨扭，卸下反光罩或其他附件。



2 找到固定槽，先套入卡盘转接座的一半，再将另一半卡紧，形成整环。



3 将保荣卡盘或其他卡口卡盘对准转接座套入。



4 使用卸下的2颗螺丝和卡口另外配的2颗螺丝固定卡盘。



5 将保荣附件或其他对应卡盘的附件插入附件卡口。

如何装卸闪光灯管

安装闪光灯管

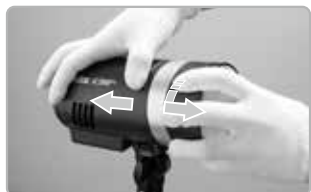

1 拨动灯罩固定按钮，卸下反光罩或者其他附件。



2 将闪光灯管三插脚对准闪光灯插座三孔，插入闪光灯。



3 先卡住玻璃灯罩卡扣弹片1，再同时扣住卡扣弹片2、3往下压，盖上玻璃灯罩。

卸下闪光灯管



1 先把玻璃灯罩从卡扣弹片2、3抽出，再慢慢从1抽出。



2 大拇指穿过灯管，用大拇指和食指侧面捏紧灯管座，用力往上拔出灯管。

电池

特性

1. 本品采用国际著名品牌锂电池，支持反复充放电500次，使用寿命长；
2. 安全可靠，内置电路有过充保护、过放保护、过流保护、短路保护；
3. 使用标配电池充电器只需2.5个小时左右。

注意事项

1. 避免正负极短路；
2. 电池没有防水功能，不要把电池浸泡在雾、水中；
3. 放置于儿童不易接触的地方；
4. 电池充电不要放置超过24小时；
5. 电池应放置于凉爽、干燥及通风的地方存储；
6. 电池不要靠近和放置于火中；
7. 电池使用报废后请按当地的规定处理；
8. 长期不使用，请充电至60%再放置；
9. 建议每3个月对电池进行一次充电保养。

电池电量指示

把锂电池正确安装在闪光灯上，即可给闪光灯供电。使用时请查看闪光灯屏幕上电池图标，即可随时掌握电量状态。

VA屏电量符号显示	意义
3格	满电
2格	中电
1格	低电
无格	电量少，请及时充电。
无格闪烁	电量即将用尽，此状态不支持闪光灯工作，1分钟后将自动关机。 注：此状态请尽快(10天内)充电，方可使用或放置。

电源管理

电源开关控制该产品的打开和关闭，长时间不使用时请关闭电源。本产品设计有电源自动休眠功能，在长时间无人操作时（30/60/90分钟），闪光灯会自动休眠。

 **C.Fn** 离机使用时，建议通过自定义功能使“自动休眠”无效。(C.Fn-F3 第17页)

造型灯

1. 开关造型灯：短按<Q>按键控制LED灯的打开和关闭。
2. 造型灯设置：长按<Q>进入造型灯设置界面。
 - 2.1. 亮度设置：按SET键，当亮度值在闪烁时，拨动SET拨轮设定亮度值，亮度等级10级(1~10)。
 - 2.2. 色温设置：按SET键，当色温值在闪烁时，拨动SET拨轮设定色温值，色温可调节范围3000K~6000K，色温差为±500K。

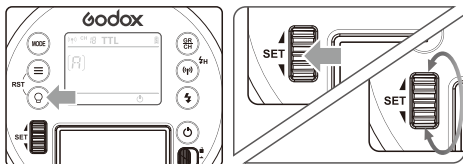

无线模式选择

AD300Pro只能作为从属单元（接收端），通过短按无线按钮进行切换无线电功能。

无线模式	闪光模式
OFF	M / Multi
无线电	TTL / M / Multi

闪光模式——TTL自动闪光模式

该闪光灯有TTL自动闪光，M手动闪光，Multi频闪光三种模式。在TTL模式下，相机的测光系统会侦查从主体反射回来的闪光照明，从而自动调节闪光输出量，使主体和背景得到均衡曝光。

按下<MODE>模式选择按钮，三种闪光模式将会依次出现在液晶屏上。

TTL模式

通过按<MODE>模式选择按钮，将闪光灯设置为<TTL>，可以使闪光灯进入TTL模式。

高速同步

使用高速同步(FP闪光)，您可以在所有的快门速度下同步使用闪光灯。高速同步闪光在使用光圈优先对人像进行填充闪光时特别方便。

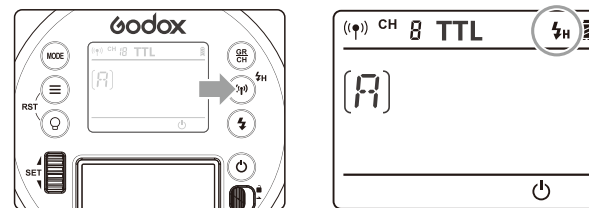

1 长按无线按钮<FP> 2秒，令屏幕显示<FP>图标。

2 发射器请使用X2系列发射器。

- 使用高速同步，快门速度越高，有效的闪光范围就越小。
- 在高速同步模式下，无法设置频闪光。
- 连续高速同步闪光20次后，闪光灯热保护功能可能会被激活。

闪光模式——M: 手动闪光

您可以在1/256功率至1/1全功率间以1/10档或1档为增量设置闪光输出。为获得正确的闪光曝光，请使用手持的闪光测光表确定所需的闪光输出。

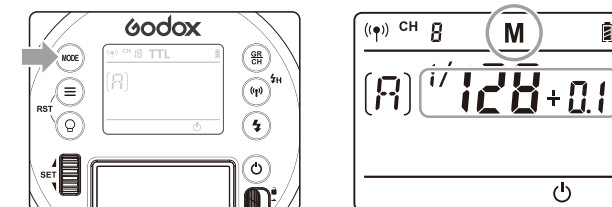

1 按<MODE>模式选择按钮，屏幕显示<M>。

2 拨动拨轮或按下SET键的同时拨动拨轮设置闪光输出功率。直接拨动拨轮以1/10档为增量，按下SET键的同时拨动拨轮以1档为增量。

闪光模式——M: 手动闪光

S1光控单元设置

在M手动闪光模式下，按MENU按钮进入C.FN-F2选择S1功能，闪光灯可作为副灯使用，创造多种照明效果，适用于手动闪光环境。它会与主闪光灯的第一次闪光同步触发闪光，效果与使用无线引闪器一致。

S2光控单元设置

在M手动闪光模式下，按MENU按钮进入C.FN-F2选择S2功能，闪光灯可作为副灯使用，适用于TTL闪光环境。具有防预闪功能，使用带一次预闪功能的相机能用光控实现同步拍摄。它会与主闪光灯的第二次闪光同步触发闪光，即2次光控引闪。

❶ 只有在M模式下才支持S1/S2光控引闪模式。

显示闪光持续时间

闪光持续时间是指闪光灯从开始发光到达发光半峰值的时间长度。半峰值的表示为 $t=0.5$ 。为了给摄影师提供更详细的拍摄数值，本产品采用 $t=0.1$ 。如下图： $t=0.5$ 与 $t=0.1$ 区别。

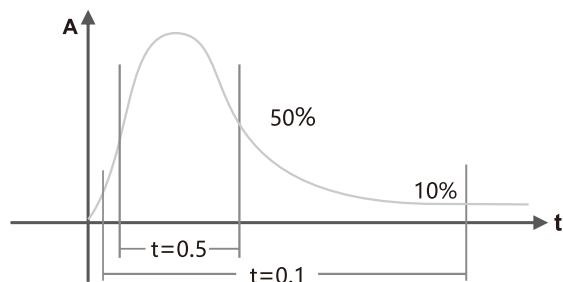

显示闪光持续时间操作：

- 1、按MENU按钮进入C.FN功能
- 2、拨动调节旋钮至F6，此时 $t=0.1$ 图标显示。
- 3、按下<SET>设置按钮进入调整状态。
- 4、拨动调节旋钮进行选择。
ON：显示闪光持续时间；OFF：不显示。

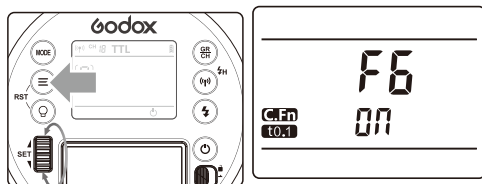

❶ 只有在M模式下才会显示持续时间。

色温恒定

使用此功能全档位色温漂移在 $\pm 100K$ 左右：进入MENU C.Fn-F8, 设置为ON, 色温恒定开启。在M模式下功率值由大调小时，引闪按钮指示灯会闪烁(蜂鸣器响一分钟)，此时请按引闪按钮放电，后可正常使用。

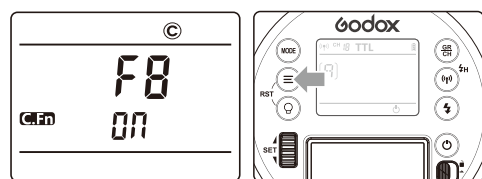

❶ 只有在M非高速模式下才支持色温恒定。

闪光模式——Multi: 频闪闪光

使用频闪闪光，可以发出一系列快速的闪光。它可以在一张照片上拍摄移动物体的多个图像。您可以设置闪光频率(每秒的闪光次数，以Hz表示)、闪光次数和闪光输出。

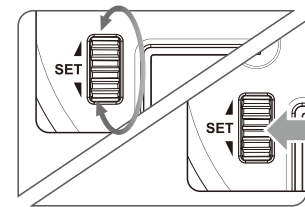
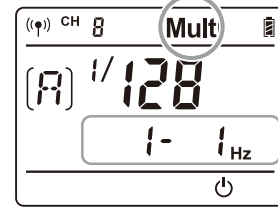
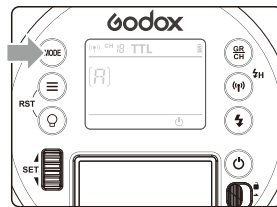

- 1 按<MODE/Z>闪光模式选择按钮，屏幕显示<MULTI>。
- 2 转动调节旋钮设置闪光输出功率。
- 3 设置闪光频率和闪光次数。
● 按<SET>按钮选择闪光频率，旋转调节旋钮设定数字。
● 按<SET>按钮选择闪光次数，旋转调节旋钮设定数字。
● 按下<SET>设置按钮确定，所有设置都将显示出来。

计算快门速度

在频闪闪光过程中，到闪光停止为止快门应保持开启状态。使用下面的公式计算快门速度，然后用相机进行设置。

$$\text{闪光次数} / \text{闪光频率} = \text{快门速度}$$

例如，如果闪光次数是10，闪光频率是5Hz，快门速度则至少为2秒。

⚠ 为防止闪光灯过热并损坏，请勿执行连续10次以上的频闪闪光连拍。闪光10次后，请让闪光灯至少冷却15分钟。如果您试图执行连续10次以上的频闪闪光连拍，为防止闪光灯过热，闪光可能自动停止。如果发生了这种情况，请让闪光灯至少冷却15分钟。

- 反光很强的被摄体在暗背景前使用频闪闪光更加有效。
- 推荐使用三脚架和遥控开关。
- 闪光输出为1/1和1/2时不能设置频闪闪光。
- 频闪闪光时也可以使用“buLb”。
- 如果闪光次数显示为--，则闪光灯会连续闪光，直到快门或电池耗尽。如下表所示，闪光次数将受到限制。

最大频闪闪光次数

闪光输出 \ Hz	1	2	3	4	5	6-7	8-9	10	11	12-14	15-19	20-50	60-99
1/4	7	6	5	4	4	3	3	2	2	2	2	2	2
1/8	14	14	12	10	8	6	5	4	4	4	4	4	4
1/16	30	30	30	20	20	20	10	8	8	8	8	8	8
1/32	60	60	60	50	50	40	30	20	20	20	18	16	12
1/64	90	90	90	80	80	70	60	50	40	40	35	30	20
1/128	90	90	90	90	90	90	80	70	70	60	50	40	40
1/256													

无线闪光拍摄：无线电(2.4G)传输

AD300Pro使用神牛2.4G无线X系统，可以与本厂其他型号完美结合使用。作为从属单元可兼容佳能/尼康/索尼TTL系统，根据主控单元自动切换，无需手动设置。尼康相机(使用X1T-N)和佳能相机(使用X1T-C)和索尼相机(使用X1T-S等)可同时间地共享一台或多台AD300Pro-TTL，无缝结合，无懈可击！

1、无线设置

按<(P)>无线按钮可以切换无线功能的开关。
无线功能打开时，显示屏上会显示<(P)>。
用本厂FT-16和其他品牌引闪器时请关闭无线功能。

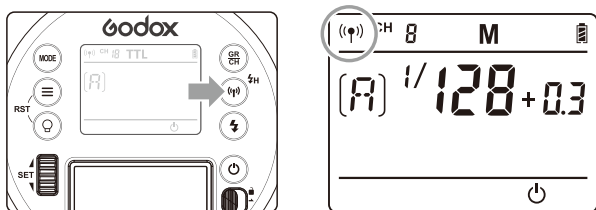

2、设置通讯频道

如果在拍摄现场不止一个无线闪光系统，您可以通过更改通讯频道来防止信号干扰。保证主控单元和从属单元设置为相同的频道编号即可。

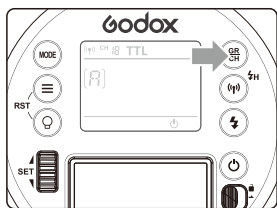

1 长按<GR/CH>按钮2秒，频道闪烁显示。

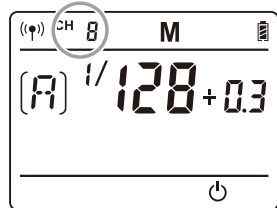

2 拨动调节旋钮从1至32中选择频道。

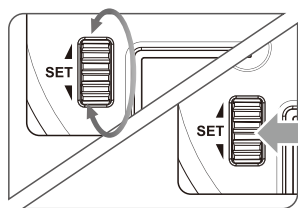

3 按下<SET>设置按钮确定。

3、设置通讯组别

短按<GR/CH>按钮，A~E组别依次改变。

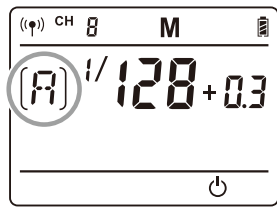
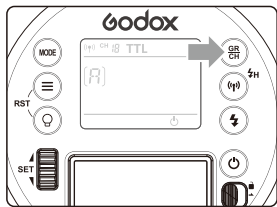

无线闪光拍摄：无线电(2.4G)传输

4、ID号设置

按MENU按钮进入C.Fn-F7可选择OFF/01-99任意数字。

(注：主控单元具备此功能时才能使用)。

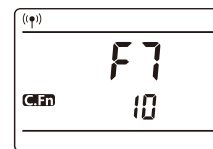

定位和操作范围(无线闪光拍摄的示例)

●使用一个从属单元进行自动闪光拍摄

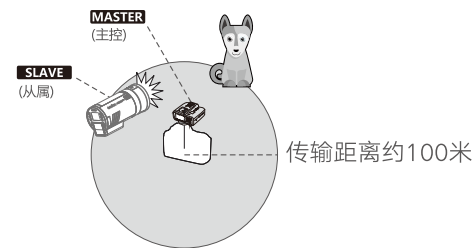

- 使用附带的支架定位从属单元。
- 开始拍摄前请进行测试闪光和试拍。
- 受从属单元的位置、周围环境、天气状况等影响，传输距离可能更短。
- 无线信号干扰很多，如果漏闪，请改变频道避免干扰。

无线多重闪光拍摄

可以将从属单元分割为两个或三个组并在改变闪光光比(倍率)的同时进行TTL自动闪光拍摄。此外，可以为各闪光组(最多5个组)设定并用不同的闪光模式拍摄。

●用两个从属组进行自动闪光拍摄。

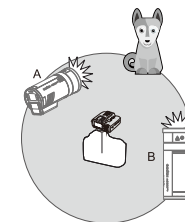

●用三个从属组进行自动闪光拍摄。

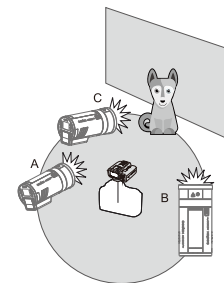

- AD300Pro和神牛X2系列发射器一起使用时，闪光灯下列功能都可以通过X2控制：
 - 闪光模式：TTL、M、Multi
 - 同步引闪：前帘、后帘、高速同步
 - 功率大小调控
 - 造型灯开关
 - 蜂鸣器开关

⚠ 神牛2.4G无线漏闪的原因及解决办法:

1、外部环境2.4G信号干扰(如无线基站、2.4G wifi路由、蓝牙设备等)

→请调节引闪器的频道CH设置(建议+10), 找到无干扰的频道来工作, 或者在工作时关闭其他2.4G设备。

2、请确认闪光灯是否已经回电或者回电速度是否已经跟上连拍速度(闪光灯就绪指示灯已经亮起), 并且没有处于过热保护或者其他异常状态中

→请下调闪光灯功率的档位, 如是TTL模式请尝试改为M模式(TTL模式下需要预闪一次)。

3、是否引闪器和闪光灯距离太近(距离<0.5m)

→请在引闪器上打开“近距离无线模式”:

X2、X1系列: 按住引闪按钮不放, 然后开机, 直至指示灯闪2次。

Xpro系列: 设置C.Fn-DIST为0-30m。

4、是否引闪器和接收端设备在低电状态

→请更换电池(引闪器电池建议使用1.5V一次性碱性电池)。

C.Fn: 设置自定义功能

请对照以下图表本机应用栏, 使用自定义功能来完成设置。

自定义功能符号	功能	设置符号	设置和说明	使用范围限制
F1	蜂鸣器	ON	启动	无
		OFF	关闭	
F2	S1/S2模式选择	OFF	关闭	M模式
		S1	S1模式	
		S2	S2模式	
F3	自动休眠	OFF	关闭	无
		30 min	没有任何操作	
		60 min	自动休眠	
		90 min		
F4	延时闪光	OFF, 0.01~30s	可作为后帘引闪	M/Multi 模式
F5	蒙板	OFF	蒙板功能关闭	M模式
		n1	蒙板功能开启:触发2次为1个周期, 触发第1次引闪。	
		n2	蒙板功能开启:触发2次为1个周期, 触发第2次引闪。	
F6	t0.1显示	ON	显示	M模式
		OFF	不显示	
F7	ID设置	OFF	关闭	无线模式
		01~99	可以选择01-99任意一个数字	
F8	恒定色温模式	OFF	关闭	M非高速模式
		ON	打开	

- 按 < MENU > 按钮进入C.Fn菜单。
- 选择自定义功能符号。
拨动设置键拨轮设置自定义功能符号。
- 更改设置。
 - 按 < SET > 设置按钮, 自定义功能编号闪烁。
 - 拨动设置键拨轮设置想要的编号, 按 < SET > 按钮确定。
- 退出C.Fn菜单。
 - 按 < MENU > 按钮退出。

其他应用

变焦功能

另购S2卡盘, 可实现变焦功能
将灯置于S2卡盘可以前后移动, 实现变焦功能, 产生聚光和散光的效果。

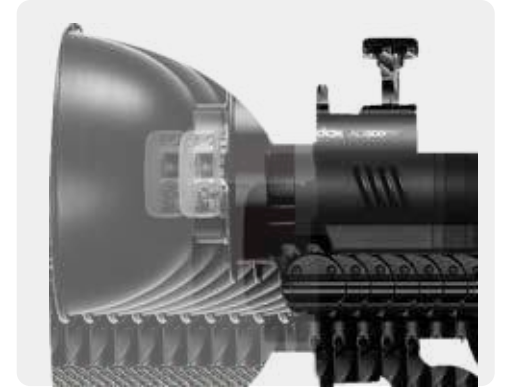

同步插孔触发

同步插孔规格为Φ3.5mm, 此处可插入同步线或者触发器触发插头对闪光灯进行同步引闪。

保护功能

1. 热保护

- 为保护灯过热损坏, 闪光多次后内部的过热保护功能会被激活, 热保护启动后, 显示屏显示“⚠”。
- 热保护时回电时间变为10秒以上, 此时请让闪光灯冷却10分钟, 闪光灯便会恢复正常。

2. 其他保护

- 为了保证设备安全的工作, 系统时刻进行预防保护, 以下提示符号供您参考:

LCD显示	警示内容
E1	闪光灯回电系统出现问题, 无法回电引闪, 请重新开机, 如无法解决请维修
E2	设备内温度过高, 请停止引闪10分钟
E3	闪光灯管两端电压过高, 请维修
E9	固件升级有误, 请进行正确固件升级

规格参数

型号	AD300Pro	
无线从属单元模式	*无线电模式(兼容Nikon&Canon&Sony&Olympus&Panasonic&Fujifilm&Pentax)	
闪光模式	无线关闭	M/Multi
	无线电从属模式	TTL/ M/Multi
无线电从属单元兼容相机	Nikon相机(主控单元X1T-N)	
	Canon EOS相机(主控单元X1T-C)	
	Sony相机(主控单元X1T-S)	
	Fujifilm相机(主控单元X1T-F)	
	Olympus相机(主控单元X1T-O)	
闪光持续时间t0.1(约)	1/220秒~1/10200秒	
POWER	300Ws	
档位	9级: 1/256~1/1	
频闪闪光	具备(次数: 90次; 频率: 99)	
闪光曝光补偿(FEC)	在使用的2.4G遥控器中调节	
同步方式	高速同步(最高1/8000秒), 前帘同步, 后帘同步	
延时引闪	0.01~30秒	
蒙板	√	
蜂鸣器	√	
Model造型灯(LED)	12W: 色温3000-6000K ± 500K/亮度1-10级	
光控引闪	S1/S2	
显示闪光持续时间	√	
•无线闪光(无线电2.4G传输)		
无线功能	从属单元, 关闭	
可控制从属单元组	5组: A, B, C, D, E	
传输距离	100m	
频道	1~32	
ID	01~99	
•电源		
电源	锂电池: 14.4V/2600mAh	
全功率闪光次数	320次左右	
回电时间	约0.01-1.5秒	
电池电量指示	√	
节能	闪光灯在无人操作30分钟(可调)将会自动休眠。	
•同步触发方式	3.5mm同步线, 无线控制插座	
•色温	5600 ± 200k	
色温恒定模式	全程档位波动 ± 100K	
•尺寸		
体积	190x100x90mm	
净重	1.25Kg(含电池)	

固件升级

本机通过USB插座可进行固件升级。软件最新公告及说明将会发布在官方网站上。

- 本品出厂不配USB升级线, 请另行购买。本产品USB接口为Type-C接口, 请使用Type-C USB线。
- 产品升级固件需要Godox G3程序软件支持, 升级固件前请先下载安装"Godox G3固件升级软件"再选择相应的固件文件。
- 由于产品进行固件升级, 说明书请以最新电子版为准。

维护保养

- 闪光灯在工作时, 如发现异常, 应立即关掉电源, 查明原因。
- 灯体应避免震动, 平时注意表面除尘。
- 灯体稍有发热为正常现象, 无特别需要时, 勿连续引闪。
- 闪光灯的所有维修概由本厂指定可供原厂配件之维修部负责。
- 1年保修, 消耗品如灯管等, 不在1年保修范围。
- 经发现, 擅自检修此闪光灯的, 将取消闪光灯之一年保修期, 维修需要收取相关费用。
- 如果本品出现故障或者被水淋湿, 在专业人员维修后方可继续使用。
- 如有技术更改, 恕不另行通知。

Foreword

Before using this product

Please read this user manual carefully in order to ensure your safety and the proper operation of this product. Keep for future reference.

Thank you for purchasing a GODOX product.

AD300Pro Outdoor Flash has strong power with light weight, compact size and great portability. Equipped with rechargeable and long-life lithium battery, AD300Pro supports various of accessories by replacing different adapter rings.

Built-in Godox 2.4G wireless X system and fully support of TTL function, your shooting process will become more smooth using AD300Pro. Easily achieve a correct flash exposure even in complex light-changing environment.

The AD300Pro offers:

- **Compatible wireless TTL system:** Fully support TTL/M/Multi functions of Canon, Nikon, Sony, Fuji, Olympus, Panasonic and Pentax cameras. Workable as Slave unit in a wireless flash group.
- **Lightweight and portable:** up to 300Ws.
- **High-quality VA panel:** with clear and convenient operation.
- **Built-in 2.4G wireless transmission:** with all-in-one functions and 100 meters further transmission.
- **Battery pack:** Large-capacity power supply (lithium, 14.4V/2600mAh), 0.01- 1.5s recycling and over 320 full power flashes.
- **Wireless control:** With built-in Godox 2.4G wireless X system to achieve TTL control. Godox FT-16 flash trigger can also be used to wirelessly adjust flash power level and trigger the flash. AD300Pro has 3.5mm sync cord jack to achieve various sync triggering mode.
- **Power adjusts from full power to 1/256 in 81 levels.**
- **Change within $\pm 100K$ over the entire power range in color temperature mode.**
- **1/8000s high-speed sync flash, high-speed sync triggering.**

The powerful and portable AD300Pro meets the demands of freelance commercial photographers, photojournalists, wedding and beach portraiture shooters, event and backpack photographers, photograph enthusiasts, etc.

Warning

- ▲ Always keep this product dry. Do not use in rain or in damp conditions.
- ▲ Do not disassemble. Should repairs become necessary, this product must be sent to an authorized maintenance center.
- ▲ Keep out of reach of children.
- ▲ Stop using this product if it breaks open due to extrusion, falling or strong hit. Otherwise, electric shock may occur if you touch the electronic parts inside it.
- ▲ Do not fire the flash directly into the eyes (especially those of babies) within short distances. Otherwise visual impairment may occur.
- ▲ Do not use the flash unit in the presence of flammable gases, chemicals and other similar materials. In certain circumstance, these materials may be sensitive to the strong light emitting from this flash unit and fire or electromagnetic interference may result.
- ▲ Do not leave or store the flash unit if the ambient temperature reads over 50°C. Otherwise the electronic parts may be damaged.
- ▲ Turn off the flash unit immediately in the event of malfunction.
- ▲ The light source of this luminaire is not replaceable; when the light source reaches its end of life the whole luminaire shall be replaced.
- ▲ Minimum distances from flammable materials: 10cm.

Contents

21	Foreword
22	Warning
25	Name of Parts
	Body
	VA Panel
	Included Accessories
	Separately Sold Accessories
	Replacing Adapter Rings and Accessories
	Attaching and Detaching Flash Tube
30	Battery
30	Power Management
31	Modeling Lamp
31	Wireless Flash Mode
31	Flash Mode—TTL Autoflash
31	TTL Mode
	 High-Speed Sync
32	Flash Mode—M: Manual Flash
34	Flash Mode—Multi/Stroboscopic Flash
35	Wireless Flash Shooting: Radio (2.4G) Transmission
37	C.Fn: Setting Custom Functions
38	Other Applications
	Zooming Function
	Sync Triggering
39	Protection Function
40	Technical Data
41	Firmware Upgrade
41	Maintenance

Conventions used in this Manual

- This manual is based on the assumption that both the camera and camera flash's power switches are powered on.
- Reference page numbers are indicated by "p.***".
- The following alert symbols are used in this manual:
 - ▲ The Caution symbol indicates a warning to prevent shooting problem.
 - The Note symbol gives supplemental information.

Name of Parts

Body:

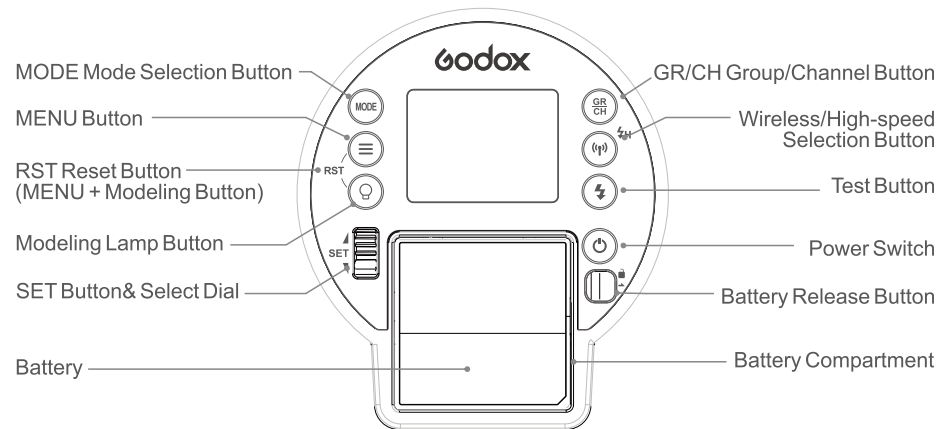
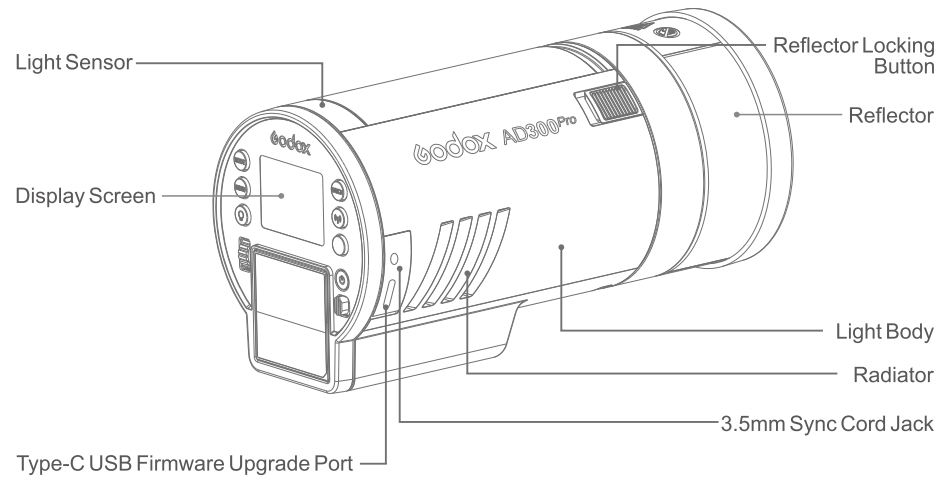

Name of Parts

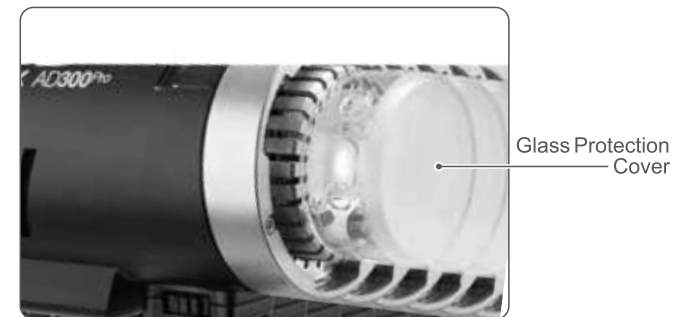
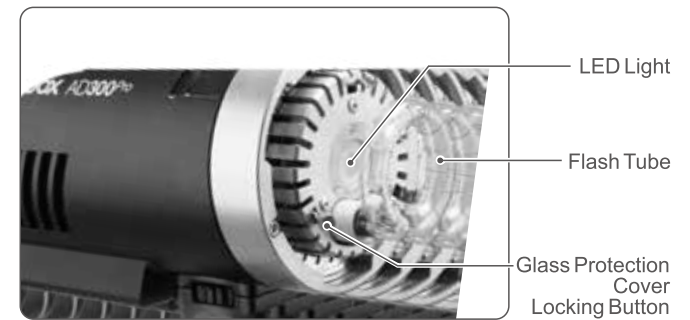
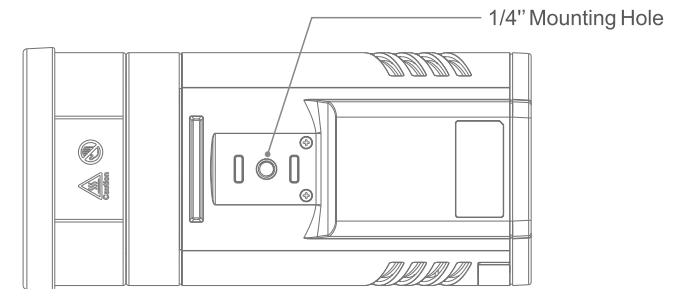

Name of Parts

VA Panel

(1) VA Panel

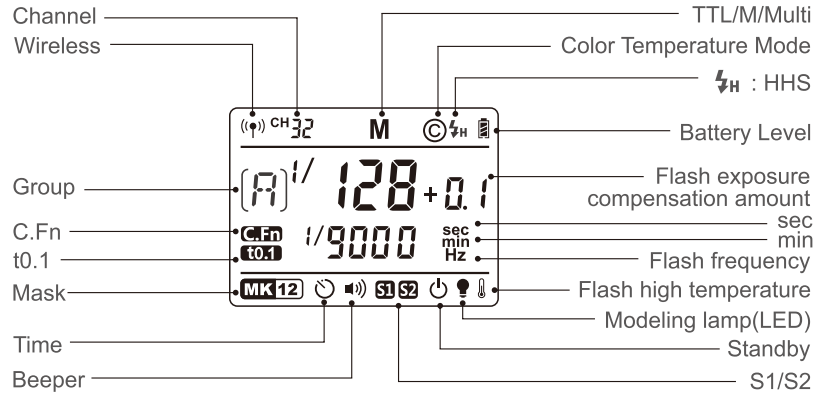

- The display will only show the settings currently applied.
- The functions displayed above function buttons 1 to 4, such as **SYNC** and **±**, change according to settings' status.
- When a button or dial is operated, the VA panel illuminated.

(2) M Manual Flash

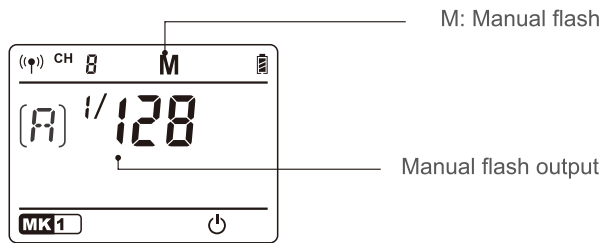

(3) Multi Flash

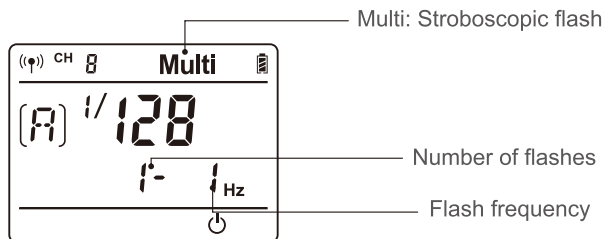

Name of Parts

(4) Radio Transmission Shooting

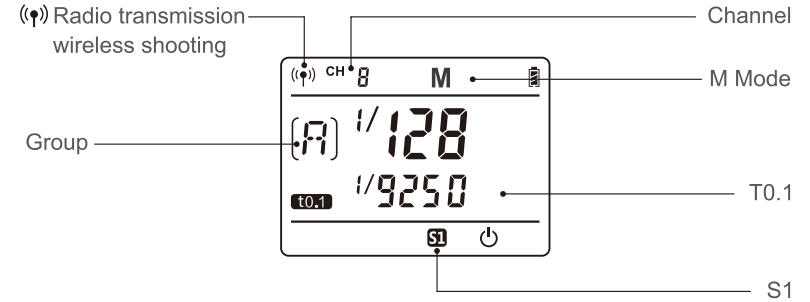

- S1/S2

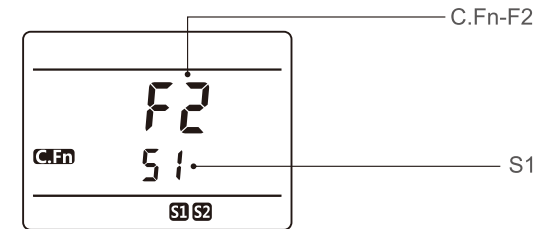

Included Accessories

1. Light body
2. Flash tube
3. Glass protection cover
4. Reflector
5. AD-E2 bracket
6. Battery
7. Charger
8. Portable bag
9. Instruction manual



Separately Sold Accessories

The product can be used in combination with the following accessories sold separately, so as to achieve best photography effects: XPro, X2 and X1 Wireless Flash Trigger, Adapter Ring Holder, Bowens/Elinchrom/Comet mount adapter ring, Barn Adapter Rings, Softbox, Beauty Dish, Fold up umbrella, Snoots, Light stand, etc.



Name of Parts

Replacing Adapter Rings and Accessories



1 Remove the reflector or other accessories from the flash head.



2 Install the first half of adapter holder into the fixing slot. Then, install another half to form a circle.



3 Match the Bowens mount or other adapter ring to the adapter holder.



4 Tighten the four screws.



5 Install the accessories of different mounts. If needed to use new Godox-mount accessories after installing the adapter ring of other brand, just install them directly.

Attaching Flash Tube

Install Flash Tube



1 Remove the reflector or other accessories from the flash head.



2 Match the flash tube in the Tube Socket. Push the flash tube in until it is securely seated into the socket.



3 Firstly, lock tightly spring 1 and press down the spring 2 and 3 simultaneously. Then, install the glass protection cover.

Detach Flash Tube



1 Pull out the glass protection cover from the spring 2 and 3 before 1.



2 Pinch the flash tube holder with your thumb and forefinger and pull out the tube upwards.

Lithium Battery

Features

1. This flash unit uses Li-ion polymer battery which has long runtime. The Available charge-and-discharge times are 500.
2. It is reliably safe. The inner circuit is against overcharge, overdischarge, overcurrent, and short circuit.
3. Take only 2.5 hours to fully charge the battery by using the standard battery charger.

Cautions:

- Do not short circuit.
- Do not expose to rain or immerse into water. This battery is not water proof.
- Keep out of reach of children.
- No over 24 hours' continuous charging.
- Store in dry, cool, ventilated places.
- Do not put aside or into fire.
- Dead batteries should be disposed according to local regulations.
- Long time not to use, please charge it to 60% and then placed.
- It is recommended to fully recharge the battery every three months.

Battery Level Indication

Make sure the battery pack is securely loaded in the flash. Check the battery level indication on the VA panel to see the remaining battery level.

Battery Level Indication on the VA Panel	Meaning
3 grids	Full battery
2 grids	Medium battery
1 grid	Low battery
Blank grid	Lower battery, please recharge it.
Blinking	The battery level is going to be used out immediately. And the flash will auto power off in 1 minute. Note: Please recharge the battery as soon as possible (within 10 days). Then, the battery can be used or be placed for long period.

Power Management

ON/OFF Power Switch controls the on/off of the flash unit, turn off the power pack if the flash unit will not be used for an extended period. The product design of power supply with automatic hibernation feature, When unattended operation for a long time (approx. 30/60/90 minutes), the flash will automatically standby.

 **C.Fn** Disabling Auto Power standby function is recommended when the flash is used off camera. (C.Fn-F3, Page 39)

Modeling Lamp

1. Power on/off the modeling lamp: short press the <L> to control the modeling lamp's on or off.

2. Setting: long press the <L> to enter modeling lamp setting.

2.1 Brightness setting: press the SET button and the brightness value is blinking. Turn the select dial to change the brightness value from 1 to 10 level.

2.2 Color temperature setting: press the SET button and the color temperature value is blinking. Turn the select dial to change the color temperature value from 3000K to 6000K(±500K).

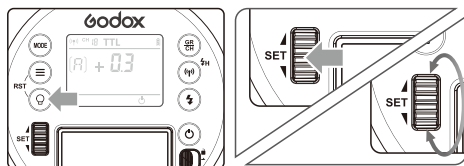

High-Speed Sync

High Speed Sync (FP flash) enables the flash to synchronize with all camera shutter speeds. This is convenient when you want to use aperture priority for fill-flash portraits.

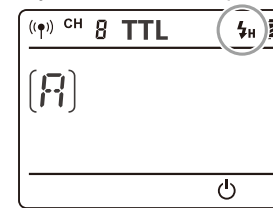
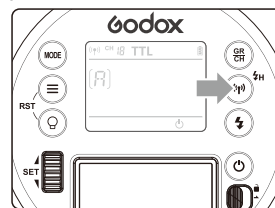

1 Long Press Wireless Button <L> for 2 seconds so that <FH> is displayed.

2 Please use the X2 series transmitter to trigger.

- With high-speed sync, the faster the shutter speed, the shorter the effective flash range.
- Multi flash mode cannot be set in high-speed sync mode.
- Over-temperature protection may be activated after 20 consecutive high-speed sync flashes.

Wireless Flash Mode

AD300Pro can only be set as slave unit (receiver end). Short press the wireless selection button to switch the radio transmission function.

Wireless Mode	Flash Mode
OFF	M / Multi
Radio Transmission	TTL / M / Multi

Flash Mode — TTL Autoflash

This flash has three flash modes: TTL, Manual (M), and Multi (Stroboscopic). In TTL mode, the camera and the flash will work together to calculate the correct exposure for the subject and the background. In this mode, multiple TTL functions are Available: FEC, FEB, FEL, HSS, second curtain sync, modeling flash, control with the camera's menu screen.

* Press <MODE> Mode Selection Button and three flash modes will display on the VA panel one by one with each pressing.

TTL Mode

Press <MODE> Mode Selection Button to enter TTL mode. The VA panel is displayed <TTL>.

Flash Mode — M: Manual Flash

The flash output is adjustable from 1/1 full power to 1/256th power in 1/10th step or 1 step increments. To obtain a correct flash exposure, use a hand-held flash meter to determine the required flash output.

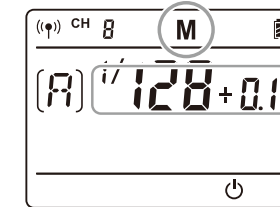
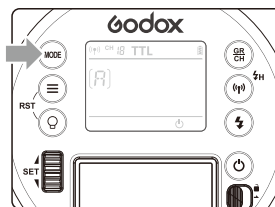

1 Press <MODE> button so that <M> is displayed.

2 Turn the Select Dial or press the SET button and turn the Select Dial simultaneously to set the flash output. The flash output will be adjustable from 1/10th increment or 1 step increment by turning the Select Dial directly or pressing the SET button and turn the Select Dial simultaneously.

Optic S1 Secondary Unit Setting

In M manual flash mode, press the <MENU> button to enter C.FN-F2 to choose S1 function, so that this flash can function as an optic S1 secondary flash with optic sensor. With this function, the flash will fire synchronously when the main flash fires, the same effect as that by the use of radio triggers. This helps create multiple lighting effects.

Optic S2 Secondary Unit Setting

Press the <MENU> button to enter C.FN-F2 to choose S2 function, so that this flash can also function as an optic S2 secondary flash with optic sensor in M manual flash mode. This is useful when cameras have pre-flash function. With this function, the flash will ignore a single “pre-flash” from the main flash and will only fire in response to the second, actual flash from the main unit.

• S1 and S2 optic triggering is only available in M manual flash mode.

Display Flash Duration

Flash duration refers to the length of time that from flash’s firing to reach the half peak at maximum. The half peak at maximum is usually expressed as $t=0.5$. In order to provide the photographer with more concrete data, this product adopts $t=0.1$. The difference between $t=0.5$ and $t=0.1$ is shown in the following picture.

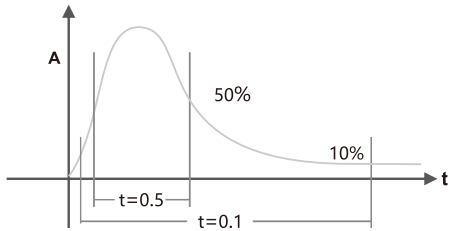

Display Flash Duration Operation:

1. Press the <MENU> button to enter C.FN function.
2. Adjust the Select Dial to F6, the $t0.1$ icon will be displayed on the VA panel.
3. Press <SET> button to enter the adjustment condition.
4. Turn the Select Dial to choose the ON/OFF.

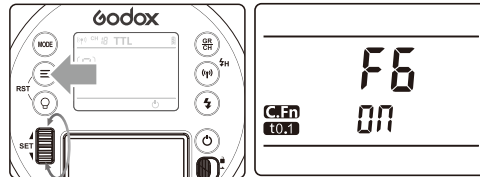

• The flash duration will only be displayed on the VA panel in M mode.

Stable Color Temperature Function

When use this function, the color temperature changes within $\pm 100K$ over the entire power range: enter MENU C.Fn-08 and set it as ON, which means the color temperature function is turned on. When adjusting the power output from high to low in M mode, Flash Ready Indicator will blink (the beeper will alarm for 1 minute). Now press the Test Button to discharge, and the flash can be used as normal.

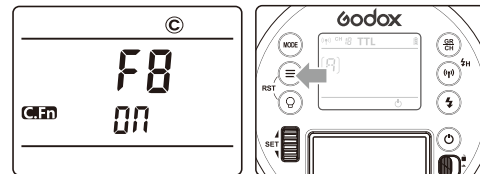

• This function can only be supported in M non-high-speed mode.

Flash Mode — Multi: Stroboscopic Flash

With stroboscopic flash, a rapid series of flashes is fired. It can be used to capture a multiple images of a moving subject in a single photograph. You can set the firing frequency (number of flashes per sec. expressed as Hz), the number of flashes, and the flash output.

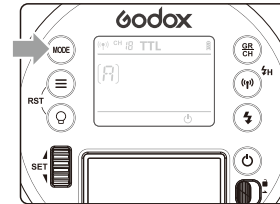

1 Press <MODE> button so that <MULTI> is displayed.

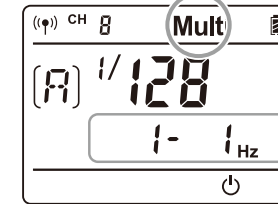

2 Turn the Select Dial to choose a desired flash output.

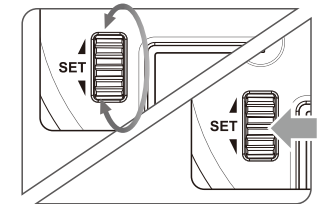

3 Set the flash frequency and flash times.
 • Press < SET > button to select the flash frequency. Turn the Select Dial to set the number.
 • Press < SET > button to select the flash times. Turn the Select Dial to set the number.
 • After finish the setting, press <SET> button and all the settings will be displayed.

Calculating the Shutter Speed

During stroboscopic flash, the shutter remains open until the firing stops. Use the formula below to calculate the shutter speed and set it with the camera.

$$\text{Number of Flashes} / \text{Flash Frequency} = \text{Shutter Speed}$$

For example, if the number of flashes is 10 and the firing frequency is 5 Hz, the shutter speed should be at least 2 seconds.

⚠ To Avoid overheating and deteriorating the flash head, do not use stroboscopic flash more than 10 times in succession. After 10 times, allow the camera flash to rest for at least 15 minutes. If you try to use the stroboscopic flash more than 10 times in succession, the firing might stop automatically to protect the flash head. If this happens, allow at least 15 minutes' rest for the camera flash.

- Stroboscopic flash is most effective with a highly reflective subject against a dark background.
- Using a tripod and a remote control is recommended.
- A flash output of 1/1 and 1/2 cannot be set for stroboscopic flash.
- Stroboscopic flash can be used with “buLb”.
- If the number of flashes is displayed as “--”, the firing will continue until the shutter closes or the battery is exhausted. The number of flashes will be limited as shown by the following table.

Maximum Stroboscopic Flashes:

Flash Output	Hz	1	2	3	4	5	6-7	8-9	10	11	12-14	15-19	20-50	60-99
1/4		7	6	5	4	4	3	3	2	2	2	2	2	2
1/8		14	14	12	10	8	6	5	4	4	4	4	4	4
1/16		30	30	30	20	20	20	10	8	8	8	8	8	8
1/32		60	60	60	50	50	40	30	20	20	20	18	16	12
1/64		90	90	90	80	80	70	60	50	40	40	35	30	20
1/128		90	90	90	90	90	90	80	70	70	60	50	40	40
1/256														

Wireless Flash Shooting: Radio (2.4G) Transmission

AD300Pro adopts Godox 2.4G wireless X system, which has good compatibility with other products of our company. As a Slave unit, AD300Pro is automatically compatible with Canon/ Nikon/ Sony TTL system according to the master unit. Nikon cameras (use X1T-N), Canon cameras (use X1T-C) and Sony cameras (use X1T-S) can use one or more AD300Pro-TTL flashes simultaneously.

1. Wireless Settings

Press the wireless selection button to switch wireless function ON/ OFF. Turn the wireless function on, the <((P))> icon will be displayed on the VA panel. When using the FT-16 remote control or others trigger, please turn off the wireless function.

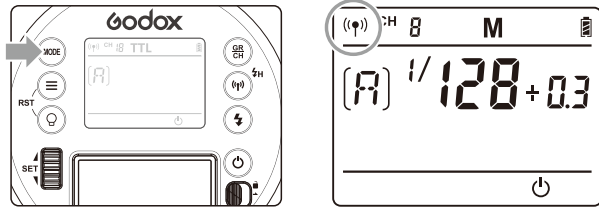

2. Setting the Communication Channel

If there are other wireless flash systems nearby, you can change the channel IDs to prevent signal interference. The channel IDs of the master unit and the Slave unit(s) must be set to the same.

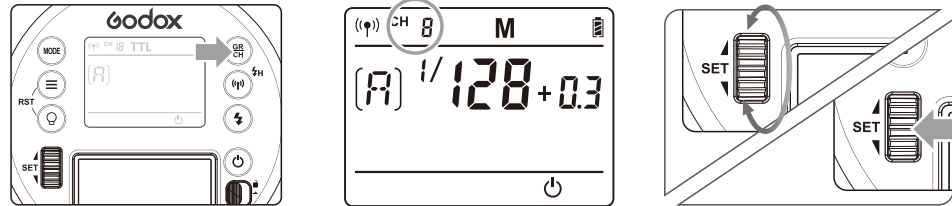

1 Long press the <GR/CH> Button for 2 seconds, so that the icon will be displayed on the VA panel.

2 Turn the Select Dial to choose a channel ID from 1 to 32.

3 Press the <SET> button to confirm.

3. Setting the Communication Group

Short press the < GR/CH > button to choose group ID from A to E.

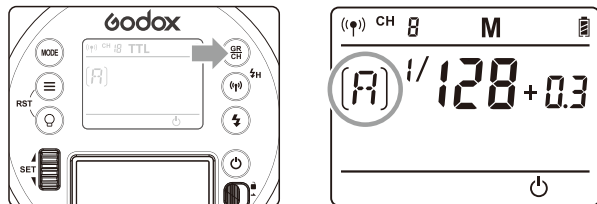

4. Wireless ID Settings

Press the MENU button to enter C.Fn to choose OFF or any figure from 01-99.

Note: This can only be used when the master unit possesses the wireless ID function.

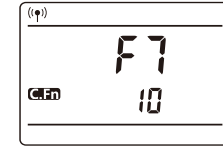

Positioning and Operation Range

(Example of wireless flash shooting)

- Autoflash Shooting with One Slave Unit

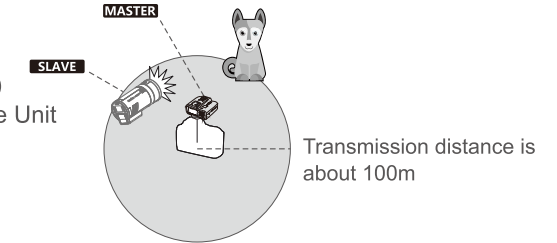

- Use the supplied stand to position the Slave unit.
- Before shooting, perform a test flash and test shooting.
- The transmission distance might be shorter depending on the conditions such as positioning of Slave units, the surrounding environment and whether conditions.
- With a lot of wireless signal interference conditions, if you miss flash, please change the wireless communication channel.

Wireless Multiple Flash Shooting

You can divide the Slave units into two or three groups and perform TTL autoflash while changing the flash ratio (factor). In addition, you can set and shoot with a different flash mode for each firing group, for up to 5 groups.

- Auto Shooting with Two Slave Groups

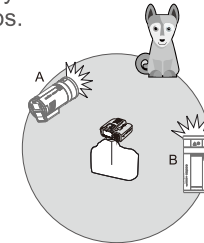

- Auto Shooting with Three Slave Groups

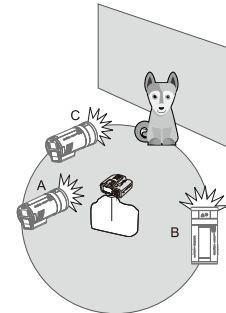

- When using the AD300Pro and Godox X2 series trigger together, the X2 can control the flash function such as:
 - Flash Mode: TTL, M, Multi
 - Sync Mode: First-curtain sync, second-curtain sync and High-speed sync
 - Control the power level
 - Modeling Lamp turn on or off
 - Beeper turn on or off 2

⚠ The Reason & Solution of Not Triggering in Godox 2.4G Wireless

- 1. Disturbed by the 2.4G signal in outer environment (e.g. wireless base station, 2.4G wifi router, Bluetooth, etc.)**
→ To adjust the channel CH setting on the flash trigger (add 10+ channels) and use the channel which is not disturbed. Or turn off the other 2.4G equipment in working.
- 2. Please make sure that whether the flash has finished its recycle or caught up with the continuous shooting speed or not(the flash ready indicator is lighten) and the flash is not under the state of over-heat protection or other abnormal situation.**
→ Please downgrade the flash power output. If the flash is in TTL mode, please try to change it to M mode(a preflash is needed in TTL mode).
- 3. Whether the distance between the flash trigger and the flash is too close or not**
→ Please turn on the "close distance wireless mode" on the flash trigger (<0.5m):
X2 & X1 series: press the test button and hold on, then turning it on until the flash ready indicator blinks for 2 times.
XPro series: Set the C.Fn-DIST to 0-30m.
- 4. Whether the flash trigger and the receiver end equipment are in the low battery states or not**
→ Please replace the battery(the flash trigger is recommended to use 1.5V disposable alkaline battery).

C.Fn: Setting Custom Functions

The following table lists the Available and unAvailable custom functions of this flash.

Custom Function Signs	Functions	Setting Signs	Settings & Descriptions	Restrictions
F1	Beeper	ON	ON	NO
		OFF	OFF	
F2	S1/S2 mode selection	OFF	OFF	M mode
		S1	S1 mode	
		S2	S2 mode	
F3	Auto standby	OFF	OFF	NO
		30 min	Auto standby	
		60 min	without	
		90 min	any operation	
F4	Delay flash	OFF, 0.01~30s	Can be triggered as second curtain	M/Multi mode
F5	Mask	OFF	OFF	M mode
		n1	ON: Trigger 2 times for 1 cycles, 1th flash of trigger.	
		n2	ON: Trigger 2 times for 1 cycles, 2th flash of trigger.	
F6	t0.1 display	ON	Display	M mode
		OFF	Not display	
F7	ID Setting	OFF	OFF	Wireless mode
		01-99	Choose any figure from 01-99	
F8	Stable Color Temperature Mode	OFF	OFF	M non-high-speed mode
		ON	ON	

- 1. Press the <MENU> button to enter the C.Fn meun.**
- 2. Select the custom function No.**
 - Turn the SET Selection Dial to select the custom function No.
- 3. Change the setting**
 - Press < SET > button and the Setting No. blinks.
 - Turn the SET Select Dial to set the desired number. Press < SET > button will confirm the settings.
- 4. Exit C.Fn menu**
 - Press < MENU > button to exit.

Other Applications

Zooming Function

Separately purchase a S2 bracket to achieve zooming function. When installed onto the S2 bracket, AD300Pro can move back and forth to achieve zooming function and gain spotlight or diffused effects.



Sync Triggering

The Sync Cord Jack is a $\Phi 3.5$ mm plug. Insert a trigger plug here and the flash will be fired synchronously with the camera shutter.

Protection Function

1. Over-Temperature Protection

- To Avoid overheating and deteriorating the flash head, the inner over-temperature protection function will be activated. When the over-temperature protection is started,  is shown on the VA display.
- When the recycle time is over 10 seconds in over-temperature protection, please allow a rest time of at least 10 minutes and the flash will then return to normal.

2. Other Protections

- The system provides real-time protection to secure the device and your safety. The following lists prompts for your reference:

Prompts on LCD Panel	Meaning
E1	A failure occurs on the recycling system so that the flash cannot fire. Please restart the flash unit. If the problem still exists, please send this product to a maintenance center.
E2	The system gets excessive heat. Please allow a rest time of 10 minutes.
E3	The voltage on two outlets of the flash tube is too high. Please send this product to a maintenance center.
E9	There are some errors occurred during the upgrading process. Please using the correct firmware upgrade method.

Technical Data

Model	AD300Pro	
Wireless Slave Unit Mode	Radio transmission mode (compatible with Nikon & Canon & Sony& Fujifilm & Olympus & Panasonic & Pentax)	
Flash Mode	Wireless off	M/Multi
	Slave unit of radio transmission	TTL/ M/Multi
Compatible Cameras under Radio Transmission (as Slave unit)	Nikon cameras (X1T-N as master unit)	
	Canon EOS cameras (X1T-C as master unit)	
	Sony cameras (X1T-S as master unit)	
	Fujifilm cameras(X1T-F as master unit)	
	Olympus cameras(X1T-O as master unit)	
Flash Duration t.01 (approx.)	1/220 to 1/10200 seconds	
POWER	300Ws	
Power Output	9 steps: 1/256~1/1	
Stroboscopic Flash	Provided (up to 90 times, 99Hz)	
Flash Exposure Compensation (FEC)	Adjust the parameters in the 2.4G remote control	
Sync mode	High-speed sync (up to 1/8000 seconds), first-curtain sync, and second-curtain sync	
Delay Flash	0.01~30 seconds	
Mask	√	
Beeper	√	
Modeling Lamp (LED)	12W;Color temperature: 3000-6000K±500K; Light brightness: 1 to 10 levels	
Optic Slave Flash	S1/S2	
Flash Duration Indication	√	
Wireless Flash (2.4G transmission)		
Wireless flash function	Slave, Off	
Controllable Slave groups	5 (A, B, C, D, and E)	
Transmission range (approx.)	100m	
Channels	32 (1~32)	
ID	01~99	
Power Supply		
Power Supply	Lithium battery pack (14.4V/2600mAh)	
Full Power Flashes	Approx. 320	
Recycle Time	Approx. 0.01-1.5s	
Battery Indicator	√	
Power Indication	Power standby automatically after approx. 30 minutes of idle operation.	
Sync Triggering Mode	3.5mm sync line, Wireless control port	
Color Temperature	5600±200k	
Stable Color Temperature	Change within ±100K over the entire power range in color temperature mode.	
Dimensions		
Dimension	190x100x90mm	
Net Weight	1.25kg (battery included)	

Firmware Upgrade

- USB connection line is not included in this product. The USB port is a Type-C USB socket. Type-C USB connection line is applicable.
- As the firmware upgrade needs the support of Godox G3 software, please download and install the "Godox G3 firmware upgrade software" before upgrading. Then, choose the related firmware file.
- As the product needs to do firmware upgrade, please refer to instruction manual of the newest electric version as final.

Maintenance

- Shut down the device immediately should abnormal operation be detected.
- Avoid sudden impacts and the product should be dedusted regularly.
- It is normal for the flash tube to be warm when in use. Avoid continuous flashes if unnecessary.
- Maintenance of the flash must be performed by our authorized maintenance department which can provide original accessories.
- This product, except consumables e.g. flash tube, is supported with a one-year warranty.
- Unauthorized service will void the warranty.
- If the product had failures or was wetted, do not use it until it is repaired by professionals.
- Changes made to the specifications or designs may not be reflected in this manual.

FCC

This device complies with part 15 of the FCC Rules. Operation is subject to the following two conditions: (1) This device may not cause harmful interference, and (2) this device must accept any interference received, including interference that may cause undesired operation.

Any Changes or modifications not expressly approved by the party responsible for compliance could void the user's authority to operate the equipment.

Note: This equipment has been tested and found to comply with the limits for a Class B digital device, pursuant to part 15 of the FCC Rules. These limits are designed to provide reasonable protection against harmful interference in a residential installation. This equipment generates uses and can radiate radio frequency energy and, if not installed and used in accordance with the instructions, may cause harmful interference to radio communications.

However, there is no guarantee that interference will not occur in a particular installation. If this equipment does cause harmful interference to radio or television reception, which can be determined by turning the equipment off and on, the user is encouraged to try to correct the interference by one or more of the following measures:

- Reorient or relocate the receiving antenna.
- Increase the separation between the equipment and receiver.
- Connect the equipment into an outlet on a circuit different from that to which the receiver is connected.
- Consult the dealer or an experienced radio/TV technician for help.

Warning

Operating frequency:2403MHz-2483.0MHz (only receive)

Declaration of Conformity

GODOX Photo Equipment Co.,Ltd. hereby declares that this equipment are in compliance with the essential requirements and other relevant provisions of Directive 2014/53/EU. In accordance with Article 10(2) and Article 10(10), this product is allowed to be used in all EU member states.For more information of DoC, Please click this web link:

https://www.godox.com/DOC/Godox_AD300Pro_DOC.pdf

The device complies with RF specifications when the device used at 0mm from your body.