

合格证
QC PASS

Godox

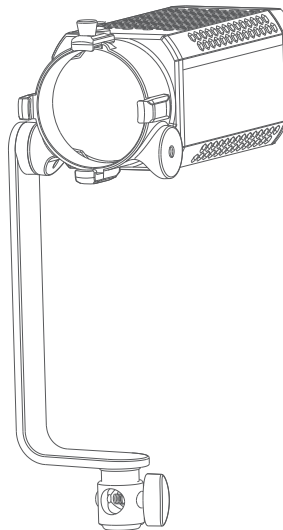

Wechat
Official Account
神牛微信公众号

深圳市神牛摄影器材有限公司

地址：深圳市宝安区福海街道塘尾社区福川工业区厂房2栋 电话：0755-29609320(8062)
传真：0755-25723423 邮箱：godox@godox.com

GODOX Photo Equipment Co.,Ltd.

Add: Building 2, Yaochuan Industrial Zone, Tangwei Community, Fuhai Street, Bao'an District, Shenzhen
518103, China Tel: +86-755-29609320(8062) Fax: +86-755-25723423 Email: godox@godox.com

www.godox.com

Made in China | 705-S60000-00



S60

LED聚光灯
Focusing LED Light

使用手册
Instruction Manual

重要的安全说明及注意事项

首先作为最基本原则：本产品为专业灯光布景设备，应由专业灯光师使用或在专业人士指导下使用。使用时必须始终遵循基本的安全预防措施，具体安全预防措施如下：

1. 使用前必须阅读并理解产品说明书。
2. 专业灯具，禁止儿童使用。当儿童靠近时，家长或监护人必须密切监督，以免儿童因碰撞灯具或私用灯具造成人身伤害。
3. 本灯具并非普通照明灯具，不可用于普通照明，任何有过眼部损伤或眼部敏感的人群均应避免使用本灯具。
4. 灯具点亮时，必须小心使用，禁止接触高温部件，如LED灯珠，以免造成灼伤。
5. 灯具点亮时，任何情况下均禁止直视灯珠。应该在专业灯光师指导下使用强光，任何情况下避免长时间处于强光环境，如引起眼睛不适，请及时关闭灯具，暂停使用，请及时就医。
6. 倘灯具损坏或因热变形，应停止使用，并及时联系制造商、服务代理商或合格的维修人员更换灯珠，以免发生意外。
7. 本产品仅适用于-10°C-40°C工作环境温度及正常湿度环境下使用。
8. 请勿使用损坏的设备或设备配件，待专业维修人员检查维修，确认设备正常方可使用。
9. 在使用过程中，如果本产品由于跌落、受到挤压或遭受强烈冲击而造成外壳破裂的，请勿继续使用，以免因接触到内部电子元件而受到电击伤害。
10. 如需要延长线，请使用额定电流>该设备额定电流的延长线。如延长线额定电流小于该设备，可能导致过热。
11. 部分产品电源线较长，请合理放置电源线，使其处于安全位置。避免电源线接触过热物体表面，避免放置不当导致拉扯损坏或绊倒现场人员。请使用原厂原装电源线，如使用非原厂电源线导致产品损坏，概不在本厂维修范围内。
12. 在清洁和维修之前，请务必从电源插座上拔下该设备插头。不使用时，禁止拉扯电源线以将设备插头从电源插座中拔出。正常断电，应是用手抓住该设备插头两端，将插头从电源插座中拔出。此设备需连接到接地插座中。
13. 本设备没有防水性能，请让设备保持干燥，请勿将本设备浸入水中或其他液体中。设备需安装在干燥且通风处，避免在雨天、潮湿、多尘或过热环境下使用。请勿将任何物体置于灯具上或使液体流入灯具内部，以免发生意外。
14. 请勿私自拆卸产品，如产品出现故障，须由本公司或授权的维修人员进行检查维修。
15. 存放本设备之前，请确保设备已完全冷却。存放时，将电源线从设备上拔出。设备应放置于设备便携包内或通风干燥处。
16. 请勿将设备放置在酒精、汽油等易燃易爆挥发的溶剂附近。
17. 本厂不推荐的产品附件，请勿使用，以免导致火灾、触电或人身伤害。
18. 清洁本设备时，请勿用湿布擦拭，请用干布，软布擦拭设备污垢。
19. 设备使用前，请注意将保护罩取下。
20. 本产品已通过ROHS, CE和FCC认证，请参考相关国家标准使用和操作。

21. 安全说明依据本厂严格测试制定，设备设计和规格如有变更，恕不另行通知。客户可以上神牛官网查看最新的电子版说明，了解产品最新资讯。
22. 部分产品内置锂电池。此类产品请使用专用的充电器进行充电，并且按正确的操作说明，在规定的电压、温度范围内使用。
23. 部分产品使用电池供电。此类产品请勿使用说明书中未指定的任何电池、电源或附件。请将电池和其他附件置于儿童及婴幼儿无法触及之处。如果儿童或婴幼儿吞下电池或附件，请立即就医。如果电池漏液、变色、变形、冒烟或发出异味，请立即将其取出。在取出过程中请小心，以免受伤。如果继续使用，可能会引起火灾、触电或皮肤烫伤。请勿使用任何变形或改造过的电池。请勿拆卸或改造本产品或电池。请勿加热电池或焊接电池。请勿让电池与火或水接触。请勿让电池受到强烈的外力撞击。请勿将电池的正负端错误插入，或将新旧电池或不同类型的电池混合使用。
24. 一年保修期，消耗品电池、适配器、电源线等配件不在此保修范围内。
25. 经发现，擅自检修设备，将取消一年保修期，维修需要收取相关费用。
26. 对于不规范操作引起的机器故障不在保修范围内。

保存这些说明

前言

感谢您购买神牛产品!

LED聚光灯S60光源稳定, 显色性佳, 灯控分离, 功能强大, 适用于静物拍摄、人像拍摄、采访布光以及视频拍摄等。可以精细调节亮度, 附件丰富, 操作简便。

主要特点

- 专门设计镜片, 光效柔和, 中心、边缘光效输出均匀, 得到更佳拍摄效果
- 可变焦, 能看到投影的硬度、大小、边缘对比度的变化
- 配合丰富附件, 精确控光, 打造更多创意光效
- 带有2.4G、蓝牙无线传输功能、DMX功能
- 小巧轻便, 为各类场景提供可移动的光源
- 色温恒定, 亮度可调
- 静音模式: 零噪音, 无干扰
- 灯体/控制器分离, 操控更便捷, 散热性更佳

警告

- △ 请勿私自拆卸产品, 如产品出现故障须由本公司或授权的维修人员进行检查维修。
- △ 此机有温度保护功能, 当温度过高时进入保护状态, 当温度降低后恢复正常。
- △ 摄影灯采用电源插头做为断接装置, 应保持随时便于操作。
- △ 本产品不能防水, 在雨天及潮湿的环境下注意防水。
- △ 在不使用时, 请断开电源。
- △ 本灯具光源仅可由制造商、其服务代理商或相关合格人员更换。
- △ 倘灯泡损坏或热变形, 应及时更换。
- △ 本灯具仅供专业使用。

部件名称

- 主机

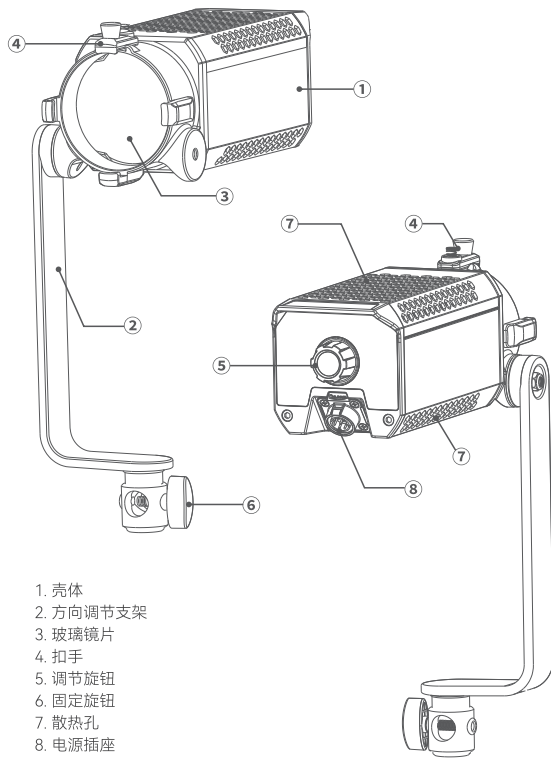

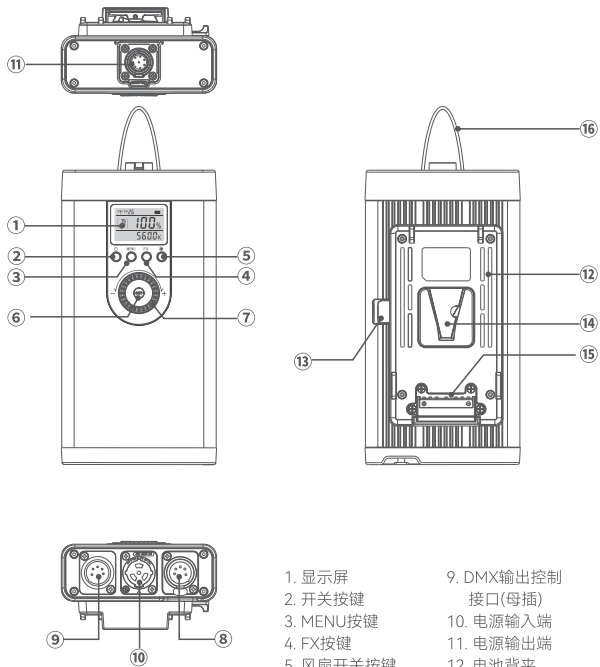

- | | |
|------------------|------------------|
| 1. 显示屏 | 9. DMX输出控制接口(母插) |
| 2. 开关按键 | 10. 电源输入端 |
| 3. MENU按键 | 11. 电源输出端 |
| 4. FX按键 | 12. 电池背夹 |
| 5. 风扇开关按键 | 13. 电池推钮 |
| 6. SET按键 | 14. 电池卡座 |
| 7. +-调节拨轮 | 15. 电池触针底座 |
| 8. DMX输出控制接口(公插) | 16. 钢丝绳 |

标配物品

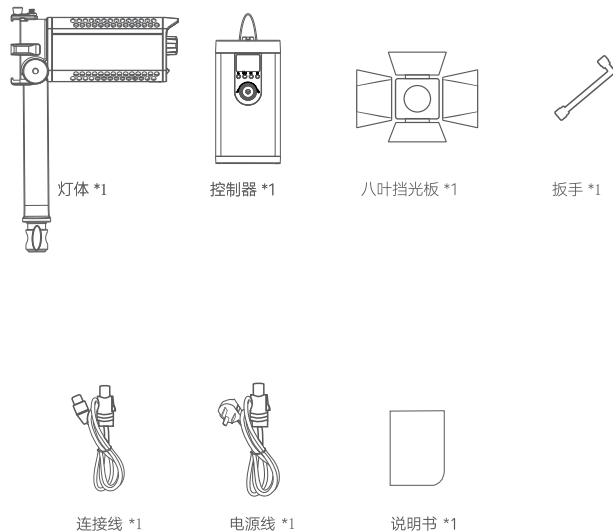

可选购附件

可搭配本公司以下摄影附件使用，以获得最佳的拍照效果和使用体验：



SA-P投影器
(包含SA-01 85mm镜头)



SA-01
85mm镜头



SA-02
60mm广角镜头



SA-03
150mm长焦镜头



SA-05
减光纱网



SA-06
可调光罩



SA-07
挡光片

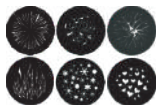

SA-09
投影片



SA-10
投影片座



SA-11C(色彩效果组)
SA-11T(色温调整组)
色片



RC-A6遥控器

供电方式

• 第一种：AC电源供电

1. 将电源连接线两端分别对准控制器电源输出接口和灯体电源输入接口插入，听到“咔”声表示插到位。

2. 将电源线输出端对准控制器输入接口插入，然后向右旋转15°，听到“咔”声表示装到位。电源线拔出方式：将电源线输出端的推钮往外推同时向左旋转15°拔出即可。

3. 电源线插入插座，接通电源。

连接线拔出方式：将连接线端上的弹片按压同时拔出即可。

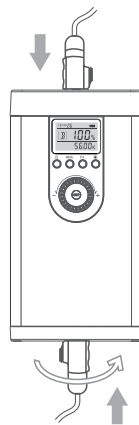

• 第二种：V口电池(另购)供电

直接将V口电池插入控制盒电池背夹上，打开电源开关即可使用。

注：V口电池请使用标准电压为14.8V，请勿使用电压超过16.8V的电池供电。

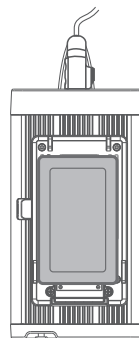

操作说明

• 开关:

短按电源开关键，LED灯亮，再短按一次LED灯熄灭。

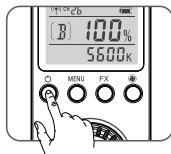

• 亮度调节:

在主界面，拨动+-调节拨轮，可进行亮度调节(0~100%)。

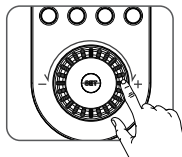

• 光效模式设置

在常态下，短按一次FX按键，进入光效模式界面，拨动+-调节拨轮可选择光效场景。FX光效模式有8种(OFF/1~8)，模拟各种拍摄场景，轻松实现创意光效。

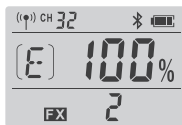



显示	FX1	FX2	FX3	FX4	FX5	FX6	FX7	FX8
场景	Flash 1	Flash 2	Flash 3	Storm 1	Storm 2	Storm 3	TV	坏灯泡

设置好后再次短按FX键或SET键退出光效模式，返回到主界面。

注：选择1-8光效场景，主界面显示FX图标及光效类型，并可调节亮度，不显示色温；若选择OFF档位，主界面不显示FX图标，显示色温。

• 静音模式

在常态下，短按风扇按键, 可进行风扇开关。风扇关闭时，进入静音模式，显示屏上方出现图标，亮度可调范围为0%-50%。



注：默认状态为风扇开启，显示屏上方无图标出现。

控制模式选择

• 1. 2.4G无线控制:

静音LED摄影灯S60具有2.4G无线接收功能，可另购遥控器RC-A6进行无线遥控，使用2.4G无线技术功能，可同时分别控制16组LED灯，32个频道，99个无线ID，抗干扰强。

注：使用前请把遥控器与LED灯的频道(CH),组别(GR), ID设为一致，LED灯在开机的状态下才能接收无线信号。

• CH频道调节/GR组别调节/ID值调节:

在主界面，短按一次MENU按键，再拨动+-调节拨轮可进行CH频道、GR组别、ID值进行切换调节；在CH频道界面，短按一次SET键，参数图标闪烁；然后拨动+-调节拨轮可进行频道(CH)调节(1~32)；调节好后短按SET键确认，参数图标停止闪烁。

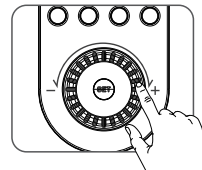
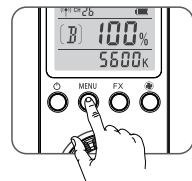

在GR组别界面，短按一次SET键，参数图标闪烁；然后拨动+-调节拨轮可进行组别(GR)调节(A-F、0-9)，调节好后短按SET键确认，参数图标停止闪烁。



在ID界面，短按一次SET键，参数图标闪烁；然后拨动+-调节拨轮可进行ID调节(1~99 / OFF)，调节好后短按SET键确认，参数图标停止闪烁。

设置好后短按MENU键，返回到主界面。

注：10秒后无操作自动返回到主界面。



• 2. 蓝牙控制:

2.1 蓝牙编号显示&蓝牙重置功能

查看蓝牙编码：在主界面，短按一次MENU按键，再拨动+-调节拨轮切换，显示屏上方出现蓝牙符号即可见蓝牙编码。

蓝牙重置功能：在蓝牙编码界面长按SET按键2秒，蓝牙图标闪烁，可实现蓝牙重置功能。再短按MENU键，返回到主界面。

注：LED灯蓝牙默认开启状态。

首个移动设备（手机或平板电脑）可直接使用APP操控灯体。更换其他移动设备（手机或平板电脑）时，灯体进行蓝牙重置后，方可正常使用APP连接。



2.2 直接扫二维码即可下载“Godox Light”手机APP。（安卓和苹果系统都可以使用）

手机APP操作请打开APP里的“帮助”，里面有详细教程。



• 3. DMX控制设置:

在主界面，短按一次MENU按键，再拨动+-调节拨轮切换，直到显示屏下方出现DMX参数图标。短按SET键，此时参数图标闪烁，然后拨动+-调节拨轮可进行DMX通道设置(1~512) 快速调节10个单元值。调节好后短按SET键确认，参数图标停止闪烁。再短按MENU键，返回到主界面。



DMX参数表:

运行模式	CCT	FX	备注
地址码			
n(模式)	0-51	52-255	
n+1	DMX*(100/255) 取整数 0-100%亮度调节	DMX*(100/255) 取整数 0-100%亮度调节	
n+2		DMX*(光效总数/255)	例如：光效总数8, DMX=160, 光效率160*8/255=5

产品参数

LED聚光灯	S60	
供电方式	AC电源供电	100~240V 50/60Hz 0.9A.MAX
	V口电池	标准电压: 14.8V (另购)
输出功率	60W	
色温	5600K±300K	
100%光照度(LUX)	散光(中心区)	3200
暗室, 1米距离(≈)	聚光(中心区)	40000
CRI	≥96	
TLCI	≥97	
调光范围	0~100%	
频道(CH)	32个 (1~32)	
组别 (GR)	16组 (A~F, 0-9)	
照射角度	6°-55°	
工作环境温度	-10~40°C	
控制方式	手机APP/2.4G无线遥控/DMX控制	
2.4G无线传输距离	50米	
产品尺寸(≈)	灯体: 264*107*100mm	
	控制盒: 268*113*64mm	
净重(≈)	灯体: 1.36kg	
	控制盒: 0.94kg	

* 设计和规格如有变更, 恕不另行通知。

维护保养

- 1年保修, 消耗品电池, 电源线, 电源连接线等配件不在此保修范围内
- 经发现, 擅自检修此补光灯的, 将取消LED灯之一年保修期, 维修需要收取相关费用。
- 对于不规范操作引起的机器故障不在保修范围内。
- 所有维修概由本厂指定可供原厂配件之维修部负责。
- 为了防止灰尘的堆积影响到产品的性能, 请定时用干净的湿布轻轻擦拭产品外部。
- 如果本品出现故障或者被水淋湿, 在专业人员维修后方可继续使用。
- 设计和规格如有变更, 恕不另行通知。

本设备包含型号核准代码为: CMIIT ID:2020DP13510, 为该产品的无线电发射模块。

Safety Instructions and Attentions

First of all, as the most basic principle: This product is a professional lighting set equipment and should be used by professional lighting engineers or under the guidance of professionals. Basic safety attentions must always be followed during use, as follows:

1. Before use, please read and understand these instructions and attentions.
2. Professional lighting is prohibited for children. When children are near, parents or accompanying persons must supervise closely to prevent children from personal injury due to collision with lamps or private use of lamps.
3. This lighting product is not ordinary lighting product and cannot be used for general lighting. Anyone who has suffered eye damage or has sensitive eyes should avoid using this product.
4. When the lamp is on, it must be used with care. Do not touch high-temperature parts, such as LED lamp beads, to avoid burns.
5. When the lamp is on, it is forbidden to look directly at the lamp beads under any circumstances. Strong light should be used under the guidance of professional lighting engineers. Avoid prolonged exposure to strong light under any circumstances. If eye discomfort, please turn off the lamp in time, suspend use, and see a doctor immediately.
6. If the lamp bead is damaged or deformed by heat, stop using this equipment, and contact the manufacturer, service agent or qualified maintenance personnel to replace the lamp bead in time to avoid accidents.
7. This product is only suitable for use in -10°C to 40°C operating environment and normal humidity environment.
8. Do not use damaged equipment or accessories, and wait for professional maintenance personnel to check and repair to confirm being normal before use.
9. During using, if the casing of this product is broken due to being dropped, squeezed or subjected to strong impact, please do not use it, so as to avoid electric shock injury due to contact with internal electronic components.
10. If an extension cord is required, please use an extension cord with a current rating greater than or equal to that of the equipment. If an extension cord is rated less than the equipment, overheating may result.
11. Some products have long power cords, please place the power cords properly and keep them in a safe place. Avoid contacting the power cord with overheating surfaces, avoid improper placement that could cause pulling damage, or trip on-site personnel. Please use the certified power cord from the original manufacturer. If the product is damaged by using a non-certified power cord, it will not be repaired by our factory.
12. Be sure to unplug equipment from the power outlet before cleaning and repairing. When not in use, do not pull the power cord to unplug the equipment. For normal power-off, please hold both ends of the plug of the equipment with your hands and pull the plug out of power outlet. This equipment needs to be connected to a grounded outlet.
13. This equipment is not waterproof, please keep it dry and do not immerse it in water or other liquids. The equipment should be installed in a dry and ventilated place, and avoid using it in rainy, humid, dusty or overheated environments. Do not place any objects on the lamp or let liquid flow into the lamp to avoid accidents.
14. Do not disassemble the product without permission. If the product fails, it must be checked and repaired by authorized maintenance personnel.
15. Before storing, make sure that the equipment has cooled down completely. For storage, unplug the power cord from the equipment. The equipment should be placed in the carrying case or in a ventilated dry place.
16. Do not place equipment near flammable and volatile solvents such as alcohol and gasoline.
17. Do not use accessories that are not recommended by our factory to avoid fire, electric shock or personal injury.
18. When cleaning, do not wipe it with a damp cloth, please use a dry cloth or a soft cloth to wipe the dirt of the equipment.
19. Please take off the protective cover before using.
20. This product complies with ROHS, CE and FCC certification, please refer to the relevant national standards for use and operation.
21. The safety instructions are formulated according to the strict testing of the factory, and the design and specifications of the equipment are subject to change without prior notice. For latest product information, please check the GODOX website and view latest electronic instruction.
22. Some products have built-in lithium batteries. Please use specified chargers, and use them within a proper range of the specified voltage and temperature according to the correct operating instructions.
23. Some products are battery powered. Do not use any batteries, power sources or accessories not specified in the instructions for such products. Keep batteries and other accessories out of the reach of children and infants. In the instance that a child or infant swallows a battery or accessory, immediate emergency medical attention is required. If the battery leaks, becomes discolored, deformed, emits smoke, or emits an abnormal odor, remove it immediately. Be careful during removal to avoid burns. Continued use could result in fire, electric shock, or burns. Do not use any deformed or modified batteries. Do not disassemble or modify this product or battery. Do not heat or solder

the battery. Keep the battery away from fire or water. Do not incorrectly insert the positive and negative ends of batteries, or mix old and new batteries or batteries of different types together.

24. One-year warranty period, accessories such as consumable batteries, adapters, power cords, etc. are not covered by this warranty.
25. If it is found that the equipment is repaired without authorization, the one-year warranty period will be cancelled and relevant fees will be charged for maintenance.
26. Machine failures caused by non-standard operation are not covered by the warranty.

keep these instructions!

Foreword

Thank you for purchasing Godox product!

Focusing LED Light S60 is excellent for product shooting, photojournalistic and video recording, etc. It creates stable light resource and even illumination for photography. This light's brightness can be precisely adjusted with easy operation.

Main Features

- With specially designed lens to gain soft and even light effect from center to edge
- Adjustable focusing range and light brightness enable you to observe the variation of shadow's hardness, dimension and edge contrast
- Precisely control the light and achieve more creative light effects when use in combination with abundant accessories
- Three ways of power supply (5V/7.4V/15V) offer great convenience, portability and wide application

Warning

- ⚠ Do not disassemble or modify. Should the product break down, send the defective back to the authorized service center for inspection and maintenance.
- ⚠ If this product overheats, it will cease operation and resume working after cooling down. This is due to the built-in over-temperature protection.
- ⚠ As this product adopts make and break device, please keep it easy to be used.
- ⚠ Keep dry. Do not handle with wet hands, immerse in water, or expose to rain.
- ⚠ Do not place in high temperature or high humidity conditions.
- ⚠ Keep out of reach of children.
- ⚠ Disconnect from the power supply when it will not be used for an extended period.
- ⚠ The light source contained in this luminaire shall only be replaced by the manufacturer or his service agent or a similar qualified person.
- ⚠ The lamp shall be changed if it has become damaged or thermally deformed
- ⚠ The luminaire is intended for professional use only.

Name of Body

• Main Body

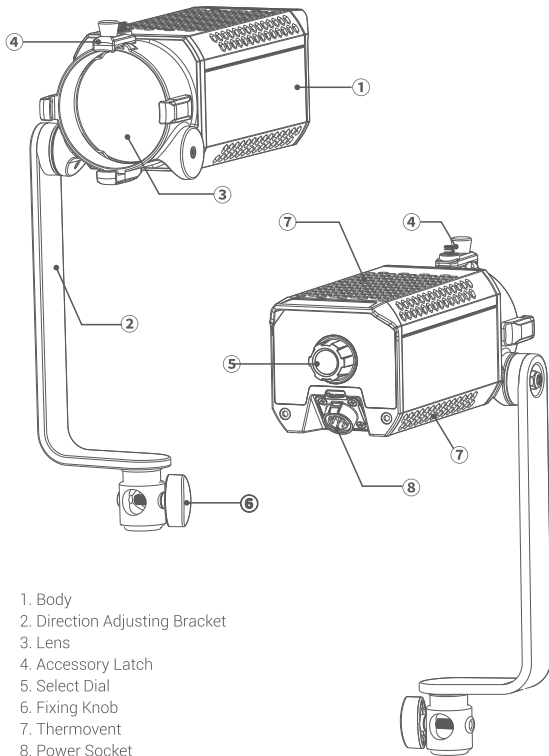

1. Body
2. Direction Adjusting Bracket
3. Lens
4. Accessory Latch
5. Select Dial
6. Fixing Knob
7. Thermovent
8. Power Socket

• Controller

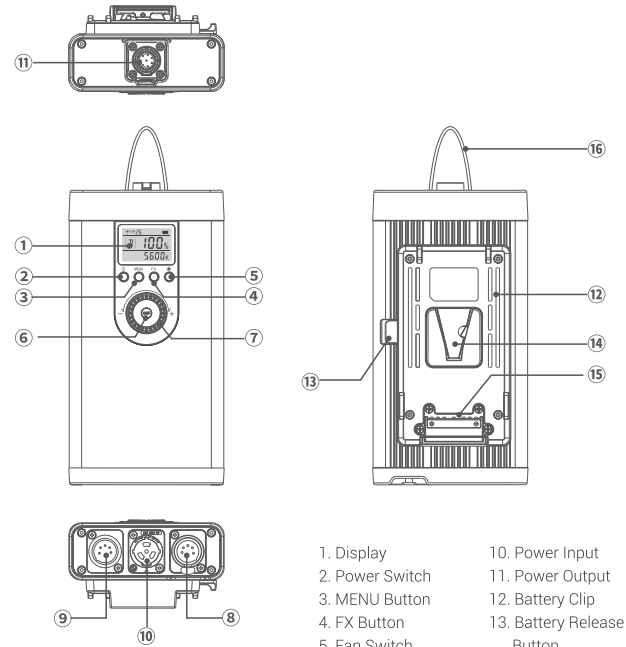

- | | |
|-----------------------------|----------------------------|
| 1. Display | 10. Power Input |
| 2. Power Switch | 11. Power Output |
| 3. MENU Button | 12. Battery Clip |
| 4. FX Button | 13. Battery Release Button |
| 5. Fan Switch | 14. Battery Compartment |
| 6. SET Button | 15. Battery Base |
| 7. + - Select Dial | 16. Steel Cable |
| 8. DMX Output Port (male) | |
| 9. DMX Output Port (female) | |

Included Items

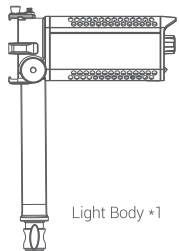

Light Body *1

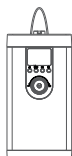

Controller *1

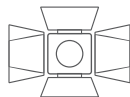

Barndoor Set *1



Wrench *1



Connect Cable *1



Power Cable *1



Instruction Manual *1

Optional Accessory

The product can be used in combination with the following accessories sold separately, so as to achieve best photography effects.



SA-P
Projection Attachment
(included a SA-01 85mm Lens)



SA-01
85mm Lens



SA-02
60mm Wide-angle
Lens



SA-03
150mm Telephoto
Lens



SA-05
Scrim Set



SA-06
Iris Diaphragm



SA-07
Framing Shutter



SA-09
GOBO Set



SA-10
GOBO Holder



SA-11C
(Color effects set)
SA-11T
(Color temperature
adjustment set)
Color Filter



RC-A6
Remote Control

Power Supply

AC Power Supply

1. Insert the two ends of power source connect cable into the controller's power output port and light's power input port until a "click" can be heard. Pull out the connect cable: press down the PUSH button and pull out the cable simultaneously.
2. Insert the power cable's output end into the controller's input port. Then, rotate it rightwards to 15° until a "click" can be heard. Pull out the power cable: press the PUSH button on the output end of power cable and rotate it leftwards to 15° to pull out.
3. Connect power cable into the power source.

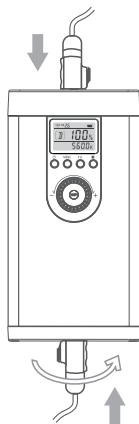

V-port Battery Power Supply (Optional)

Install the V-port battery onto the controller's battery compartment. Then, power the light on to operate.

Note: please use the standard V-port battery with 14.8V standard voltage. Do not supply power with the battery whose voltage is over 16.8V.

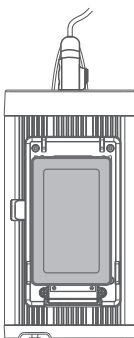

Operation

• Power switch:

Short press the power switch, and the LED light will be lighted on. Press the button again to turn off the light.

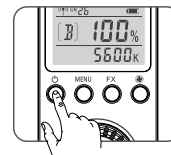

• Brightness adjustment:

In the main interface, turn the select dial to adjust brightness from 0% to 100%.

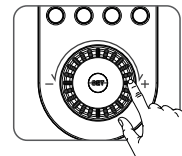

• Light effects setting:

In normal status, short press the FX button once to enter the setting interface. Then, turn the select dial to choose light effects from OFF and 1 to 8.

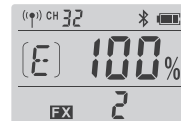

Display	FX1	FX2	FX3	FX4	FX5	FX6	FX7	FX8
Scene	Flash 1	Flash 2	Flash 3	Storm 1	Storm 2	Storm 3	TV	Broken bulb

Short press the FX button or SET button to exit from light effects modes and back to the main interface after settings finished.

Note: If a light effect is selected from 1 to 8, the FX icon and light effects will be displayed on the main interface. And the brightness can be adjusted. The color temperature will not be displayed.

If choose OFF, the color temperature will be displayed instead of FX icon.

• Silent Mode:

In normal status, short press the Fan button to turn it on or off. When turning off the fan, the LED light will enter silent mode. And the fan icon will be displayed and the brightness will be adjusted from 0% to 50%.

Note: the fan will be turned on by default and there is no icon appeared on the display.

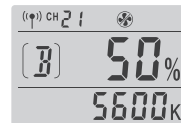

Control Mode Selection

1. 2.4G Wireless Control

With 2.4G wireless system, S60 focusing LED video light has remote grouping and control function. It is recommended to purchase RC-A6 remote control (optional) to achieve wireless control. Multiple LED lights can be controlled. 32 channels and 99 IDs are available with strong anti-interference capability.

Note:

1. Please make LED light's channel, group and ID to the same as remote control's.
2. The wireless signals can only be received in the situation that the LED light is powered on.

CH Channel Adjustment/GR Group Adjustment/ID Value Adjustment

In main interface, short press MENU button once and turn the select dial to adjust channel, group and ID values.

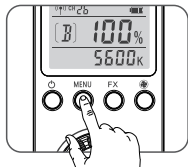

In CH channel setting interface, short press SET button and the channel icon will blink. Then, turn the select dial to choose channel from 1 to 32. Press the SET button to confirm and the icon will stop blinking.

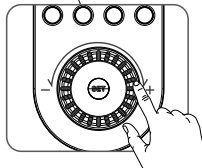

In GR channel setting interface, short press SET button and the group icon will blink. Then, turn the select dial to choose group from A to F and 0 to 9. Press the SET button to confirm and the icon will stop blinking.

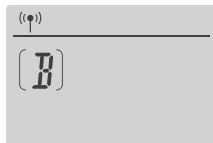

In ID channel setting interface, short press SET button and the group icon will blink. Then, turn the select dial to choose group from OFF and 1 to 99. Press the SET button to confirm and the icon will stop blinking.



After setting all these parameters, short press SET button to confirm and back to the main interface.

Note: the LED light will auto return to the main interface if there's no operation after 10 seconds.

2. Bluetooth Control

2.1 Bluetooth Code Display & RESET Function

Check Bluetooth code: in main interface, short press MENU button. Then, press the select dial to switch the icons. The Bluetooth icon will be displayed after Bluetooth icon appeared.



Bluetooth reset function: in the Bluetooth code interface, long press the SET button for 2 seconds and the Bluetooth icon will blink because of resetting. And the icon will stop blinking after successfully reset. Then, short press the MENU button to return to main interface.

Note: The LED light's Bluetooth function should be turned on. The APP can be used directly on the firstly installed device (smartphone or iPad). When change to other mobile device (smartphone or iPad), the light shall be reset before the normal connection of APP.

2.2 Scan the QR code to download the "Godox Light" smartphone APP (can be used in Android and Apple).

For more smartphone APP operations, please open the "help" in APP to gain detailed guidance.



3. DMX Control Mode

In main interface, short press MENU button once and turn the select dial to switch until the DMX icon is displayed. Short press the SET button and the icon will be blinking. Then, turn the select dial to set the DMX channel from 1 to 512. Adjustment in 10 values quickly or 1 value normally. Then, short press the SET button to confirm and the icon will stop blinking. Short press the MENU button to return to main interface.



DMX Parameters:

Operation Mode Code	CCT	FX	Note
n(Mode)	0-51	52-255	
n+1	DMX*(100/255) Integer 0-100% Brightness	DMX*(100/255) Integer 0-100% Brightness	
n+2		DMX*(total light effects/255)	For example: total light effects 8 DMX=160, light effects No.=160*8/255=5

Technical Data

Silent LED Video Light	S60	
Power Supply	AC Power Supply	100~240V 50/60Hz 0.9A
	V-port battery	Standard voltage: 14.8V (optional)
Output Power	60W	
Color Temperature	5600K±300K	
100% Illuminance(LUX) (1m,darkroom) (≈)	Flood(Central Area)	3200
	Spot(Central Area)	40000
CRI	≥96	
TLCI	≈97	
Brightness Range	0~100%	
Channel(CH)	32 (1 to 32)	
Group(GR)	16 (A to F / 0 to 9)	
Beam Angle	6°-55°	
Working Environment Temperature	-10~40°C	
Control Method	Smartphone APP/2.4G wireless remote control/DMX control	
2.4G Wireless Transmission Distance(≈)	50m	
Dimension (≈)	Light body: 264*107*100mm	
	Controller: 268*113*64mm	
New weight(≈)	Light body: 1.36kg	
	Controller: 0.94kg	
BT Frequency Range	2402.0-2480.0MHz	
Max. Transmitting Power	5dbm	

* Product design and specifications are subject to change without notice.

Maintenance

This product, except consumables e.g. battery, power cable and connect cable, is supported with a one-year warranty.

Avoid sudden impacts and the product should be dedusted regularly.

Maintenance of the flash must be performed by our authorized maintenance department which can provide original accessories.

Unauthorized service will void the warranty.

If the product had failures or was wetted, do not use it until it is repaired by professionals.

Changes made to the specifications or designs may not be reflected in this manual.

FCC Statement

This device complies with part 15 of the FCC Rules. Operation is subject to the following two conditions: (1) This device may not cause harmful interference, and (2) this device must accept any interference received, including interference that may cause undesired operation.

Any Changes or modifications not expressly approved by the party responsible for compliance could void the user's authority to operate the equipment.

Note: This equipment has been tested and found to comply with the limits for a Class B digital device, pursuant to part 15 of the FCC Rules. These limits are designed to provide reasonable protection against harmful interference in a residential installation. This equipment generates uses and can radiate radio frequency energy and, if not installed and used in accordance with the instructions, may cause harmful interference to radio communications. However, there is no guarantee that interference will not occur in a particular installation. If this equipment does cause harmful interference to radio or television reception, which can be determined by turning the equipment off and on, the user is encouraged to try to correct the interference by one or more of the following measures:

- Reorient or relocate the receiving antenna.
- Increase the separation between the equipment and receiver.
- Connect the equipment into an outlet on a circuit different from that to which the receiver is connected.
- Consult the dealer or an experienced radio/TV technician for help.

The device has been evaluated to meet general RF exposure requirement.

The device can be used in portable exposure condition without restriction.

1. The light source contained in this luminaire shall only be replaced by the manufacturer or his service agent or a similar qualified person.
2. The lamp shall be changed if it has become damaged or thermally deformed.
3. The luminaire is intended for professional use only.

Warning

Operating frequency:2412.99MHz – 2464.49MHz(2.4G only receive)/2402MHz – 2480MHz(BT)

Maximum EIRP Power: 8.92dBm

Declaration of Conformity

GODOX Photo Equipment Co.,Ltd. hereby declares that this equipment are in compliance with the essential requirements and other relevant provisions of Directive 2014/53/EU. In accordance with Article 10(2) and Article 10(10), this product is allowed to be used in all EU member states.For more information of DoC, Please click this web link: https://www.godox.com/DOC/Godox_S60_DOC.pdf

The device complies with RF specifications when the device used at 0mm from your body.

产品保修

尊敬的用户，本保修卡是申请保修服务的重要凭证，请您配合销售商填写并妥善保管，谢谢！

产品信息	型号	产品条码
用户信息	姓名	联系电话
	通信地址	
销售商信息	名称	
	联系电话	
	通信地址	
	销售日期	
备注		

注：此表应由销售商盖章确认。

适用产品

本文件适用于相关《产品保修信息》(见后面说明)所列产品，其他非属此范围的产品或部件(如促销品、赠品及其他出厂后附加的部件等)不在此保修承诺内。

保修期

产品及部件的相应保修期按相关的《产品保修信息》执行。保修期自产品首次购买日起算，购买日以购买产品时保修卡登记日期为准。

如何获得保修服务

要保修服务，您可直接与产品销售商或授权服务机构联系，也可拨打神牛产品售后服务电话，与我们联系，由我们的服务人员为您安排服务。申请保修时，您应提供有效的保修卡作为保修凭证，方可获得保修。如您不能提供有效的保修卡，则在我们可确认产品或部件属于保修范围的情况下，也可以为您提供保修，但这不作为我们的义务。

不适用保修的情况

如产品存在下列情况，本文件项下的保证和服务将不适用 ①产品或部件超过相应保修期；②错误或不适当使用、维护或保管导致的故障或损坏，如：不当搬运；非按产品合理预期用途使用；不当插拔外接设备；跌落或外力挤压；接触或暴露于不适当温度、溶剂、酸碱、水浸或潮湿环境；③由非神牛授权机构或人员安装、修理、更改、添加或拆卸造成的故障或损坏；④产品或部件原有识别信息被修改变更或删除；⑤无有效保修卡；⑥使用非法授权、非标准或非公开发行的软件造成的故障或损坏；⑦因不可抗力或意外事件造成的故障或损坏；⑧其他非因产品本身质量问题导致的故障或损坏。遇上述情况，您应向相关责任方寻求解决，神牛对此不承担任何责任。因非在保修期或保修范围内的部件、附件或软件导致产品不能正常使用的，不是保修范围内的故障。产品使用过程中正常的脱色，磨损和消耗，不是保修范围内的故障。

产品保修和服务支持信息

产品的保修期和服务类型按以下《产品保修信息》执行：

产品类别	选件名称	保修期(月)	保修服务类型
部件	电路板	12	客户送修
	电池	3	客户送修
	充电器、等带电性能的部件。	12	客户送修
其他	如闪光灯、造型灯泡、外壳、保护罩、锁紧装置、包装电源线、同步线等。	无	无保修

神牛产品售后服务电话 0755-29609320-8062

Warranty

Dear customers, as this warranty card is an important certificate to apply for our maintenance service, please fill in the following form in coordination with the seller and safe-keep it. Thank you!

Product Information	Model	Product Code Number
Customer Information	Name	Contact Number
	Address	
Seller Information	Name	
	Contact Number	
	Address	
	Date of Sale	
Note:		

Note: This form shall be sealed by the seller.

Applicable Products

The document applies to the products listed on the Product Maintenance Information (see below for further information). Other products or accessories (e.g. promotional items, giveaways and additional accessories attached, etc.) are not included in this warranty scope.

Warranty Period

The warranty period of products and accessories is implemented according to the relevant Product Maintenance Information. The warranty period is calculated from the day (purchase date) when the product is bought for the first time, and the purchase date is considered as the date registered on the warranty card when buying the product.

How to Get the Maintenance Service

If maintenance service is needed, you can directly contact the product distributor or authorized service institutions. You can also contact the Godox after-sale service call and we will offer you service. When applying for maintenance service, you should provide valid warranty card. If you cannot provide valid warranty card, we may offer you maintenance service once confirmed that the product or accessory is involved in the maintenance scope, but that shall not be considered as our obligation.

Inapplicable Cases

The guarantee and service offered by this document are not applicable in the following cases: ①. The product or accessory has expired its warranty period; ②. Breakage or damage caused by inappropriate usage, maintenance or preservation, such as improper packing, improper usage, improper plugging in/out external equipment, falling off or squeezing by external force, contacting or exposing to the improper temperature, solvent, acid, base, flooding and damp environments, etc; ③. Breakage or damage caused by non-authorized institution or staff in the process of installation, maintenance, alternation, addition and detachment; ④. The original identifying information of product or accessory is modified, alternated, or removed; ⑤. No valid warranty card; ⑥. Breakage or damage caused by using illegally authorized, nonstandard or non-public released software; ⑦. Breakage or damage caused by force majeure or accident; ⑧. Breakage or damage that could not be attributed to the product itself. Once met these situations above, you should seek solutions from the related responsible parties and Godox assumes no responsibility. The damage caused by parts, accessories and software that beyond the warranty period or scope is not included in our maintenance scope. The normal discoloration, abrasion and consumption are not the breakage within the maintenance scope.

Maintenance and Service Support Information

The warranty period and service types of products are implemented according to the following **Product Maintenance Information**:

Product Type	Name	Maintenance Period(month)	Warranty Service Type
Parts	Circuit Board	12	Customer sends the product to designated site
	Battery	3	Customer sends the product to designated site
	Electrical parts e.g. battery charger, etc.	12	Customer sends the product to designated site
Other Items	Flash tube, modeling lamp, lamp body, lamp cover, locking device, package, power cord, sync cable etc.	No	Without warranty

Godox After-sale Service Call **0755-29609320-8062**