

retrospec

Double Decker

Freestanding Bike Stand - 2 Bike



Assembly Instructions

Assembly Instructions

⚠ WARNING: Do Not Exceed maximum total load limit weight of 40lbs per bike, up to 80lbs total, 20lbs per hook.

Features

- ✓ Safely and securely cradles your bicycles within space saving reach for your next ride.
- ✓ No permanent attachment or drilling required.
- ✓ Easily assembles in minutes with only one Phillips screwdriver.
- ✓ Non-slip rubber coated arms protect your bike.
- ✓ Dimensions (bikes not loaded): 84"Height x 16"Deep x 26"Wide.
- ✓ Max load weight: 40lbs per bike, up to 80lbs total, 20lbs per hook.

Tools Required:

Phillips-head Screwdriver (not included)

Parts:



x2 - Legs

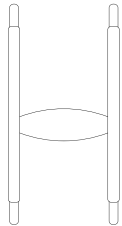

x1 - "H"-shaped section



x2 - Straight Poles

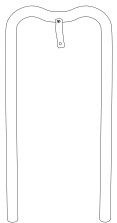

x1 - "U"-shaped section

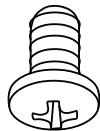

x6 - Philips Head Screws



x4 - Arms

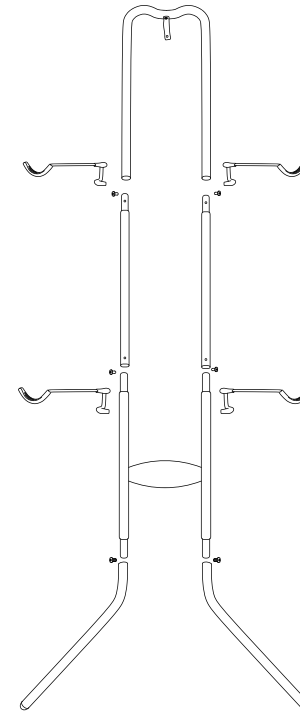

Step 1

- Attach Legs (2) to "H"-shaped section.
- Do not fully tighten the screws. You will fully tighten screws when Bike Stand is completely assembled.

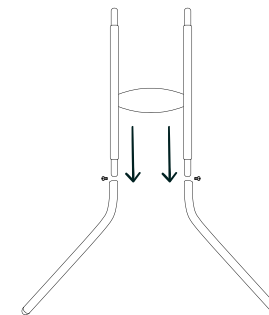

Step 2

- Attach Straight Poles (2) to the top of the “H”-shaped section.
- Do not fully tighten the screws.

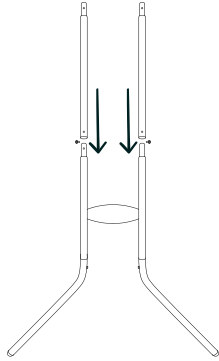

Step 3

- Attach “U”-shaped section to the Straight Poles (2).
- Legs facing forward (away from wall), “U”-shaped section optional Safety Anchor facing the wall.
- Do not fully tighten the screws.

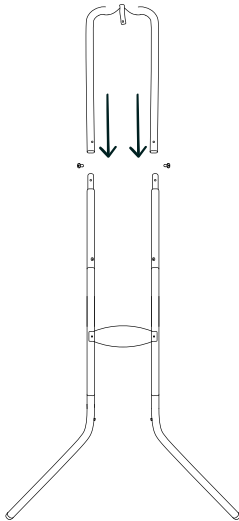

Step 4

- Tighten all screws before using.

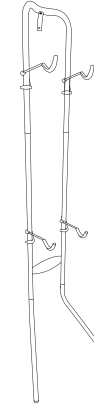

Step 5

- Install and adjust the height of the arms before loading the bike.
 - 5A – Mount the hook as shown – twist the hook and lower the Arm at the same time.
 - 5B – Make sure the hook is centered on the upright, push arm down.
 - 5C – Push Arm down firmly to seat it. The Arm may not be horizontal until loaded with bike (due to the rubber coating).
- The arms do not have to be horizontal with one another.
- Size up your bike to the width of the arms, estimate bike mounting position, adjust arms, test load bike, adjust to satisfaction.

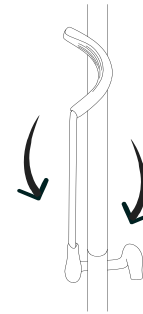

5A

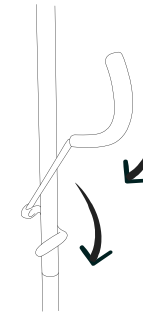

5B

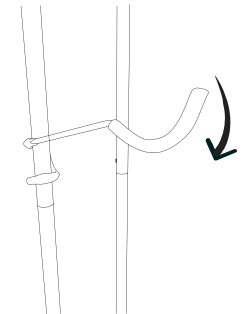

5C

⚠ IMPORTANT!

- To avoid accidental toppling of the rack, a wall anchor/stabilizing strap is attached to the rack from the factory.
- The other end of the strap should be anchored to the wall using a screw/bolt that is suitable for the type of wall construction. The screw/bolt to do so is not included with this rack.
- If you are unsure how to attach it to the wall or if any questions, we strongly suggest you consult with your hardware store expert for the correct method of attachment based on your wall construction.

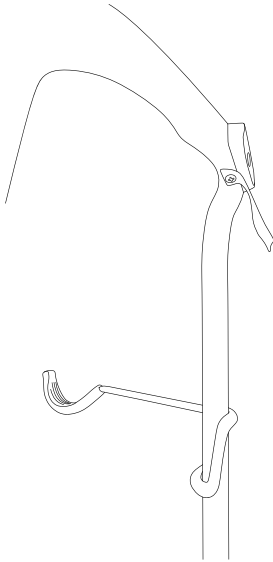

Contact Us



Need some help? Just want to say “hey” and talk to some fellow outsiders? We’re here for that too. team@retrospec.com

Give us a follow, while you’re at it:

Instagram: [@retrospec](https://www.instagram.com/retrospec)

[#retrospec](https://www.instagram.com/retrospec)

[#readytooutdoor](https://www.instagram.com/retrospec)

Making Nature Second Nature

