

合格证
QC PASS

Godox



Wechat
Official Account
神牛微信公众号

深圳市神牛摄影器材有限公司

地址: 深圳市宝安区福海街道塘尾社区耀川工业区厂房2栋 电话: 0755-29609320(8062)

传真: 0755-25723423 邮箱: godox@godox.com

GODOX Photo Equipment Co., Ltd.

Add.: Building 2, Yaochuan Industrial Zone, Tangwei Community, Fuhai Street, Bao'an District,
Shenzhen 518103, China Tel: +86-755-29609320(8062) Fax: +86-755-25723423

E-mail: godox@godox.com

godox.com

Made in China | 705-XP2L00-00

UK
CA

CE

FC



X-PRO II L

TTL无线引闪器

TTL Wireless Flash Trigger

使用手册

Instruction Manual

目录

前言	02	曝光补偿设置	10
警告	02	频闪参数值设置(输出值、次数、频率)	11
部件	03	造型灯设置	12
机身	03	ZOOM值设置	12
LCD显示屏	04	蜂鸣器设置	12
安装电池	05	PC插孔设置	13
电池电量指示	05	SHOOT功能设置	13
无线同步触发机顶闪光灯	05	蓝牙设置	14
无线同步触发外拍闪光灯	06	APP下载	14
无线同步触发影室闪光灯	06	MENU:自定义菜单	15
电源开关	07	兼容闪光灯型号	19
省电模式设置	07	兼容相机列表	20
AF对焦辅助灯开关	07	规格参数	20
频道设置	07	恢复出厂设置	21
无线ID设置	08	固件升级	21
扫描空闲频道设置	08	注意事项	22
模式设置	09	引闪器保养	22
放大功能	09		
档位值设置(功率设置)	10		

前言

感谢您购买神牛XProIII无线引闪器。

该引闪器专用于徕卡相机控制神牛闪光灯,用于操作支持神牛无线X系统的机顶闪光灯、外拍灯、影室闪光灯。多频道控制,信号稳定,反应灵敏,方便摄影师灵活布光,满足多种拍摄需求。该触发器适用于徕卡系列带热靴相机,同时可以连接具有PC接口相机使用。支持TTL闪光和高速闪光同步,最大闪光同步速度达1/8000s。

*: 限制条件——相机的最大快门速度为1/8000s

警告

⚠ 请勿私自拆卸产品,如产品出现故障须由本公司或授权的维修人员进行检查维修。

⚠ 请保持干燥:请勿用湿手接触产品,亦不可将产品浸入水中或暴露于雨中。

⚠ 请勿让儿童接触本产品。

⚠ 请勿在易燃易爆环境中使用。在这些场合下,请注意相关警告标识。

⚠ 请勿放置在超过50度的高温环境中。

若发生任何故障,请立即关闭触发器电源。

⚠ 使用电池的注意事项:

只能使用本手册中列出的电池。

请勿混用新旧电池或不同类型的电池。

请仔细阅读并遵守由厂商提供的警告或指示。

切勿使电池短路或拆卸电池。

切勿将电池投入火中或加热升温。

切勿试图以反方向安装电池。

当电量用尽时,电池容易漏液。为了避免产品受损,长期不使用本产品或者电量用尽时,请取出电池。

如果受损电池液体泄漏并触碰到皮肤或衣服,请立即用大量清水进行冲洗操作。

部件 机身

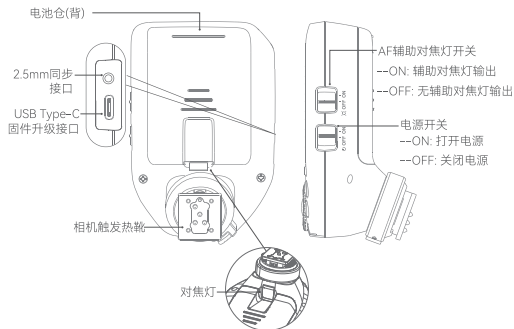
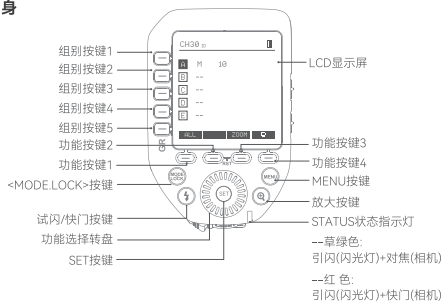

03

LCD显示屏

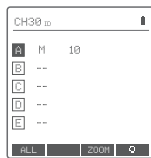
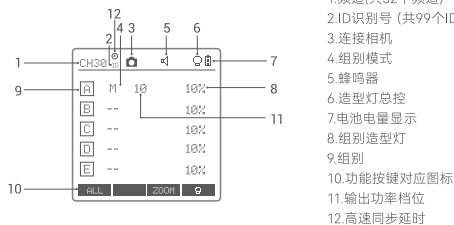

多组显示



单组显示

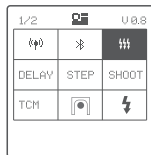

菜单显示



多组ZOOM显示

04

安装电池

滑开引闪器背面的电池盖, 根据电池盒内的正负极指示, 分别装入2节AA电池(需另购)。

电池电量指示

使用时请查看LCD屏幕上电池图标, 即可随时掌握电量状态。

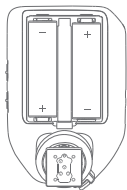

LCD屏电量符号显示	意义
3格	满电
2格	中电
1格	低电
边框	电量少, 请及时更换电池。
闪烁	2.5V电量即将用尽(此时请更换电池, 否则在距离较远时会出现漏闪或不闪现象)

此电池电量指示只对应AA碱性电池, 镍氢电池电压偏低, 请勿参考此表格。

无线同步触发机顶闪光灯

使用方法以V1系列机顶闪光灯为例:

1. 关闭相机电源, 将引闪器放置于相机热靴插座上, 打开引闪器电源开关和相机电源。
2. 短按<MENU>按钮进入自定义菜单, 转动功能选择转盘至<无线功能>, 再按<SET>按钮可以设置组别、模式和参数。(详情请见“设置引闪器”)。
3. 打开机顶闪光灯电源, 短按无线按键, 令屏幕显示无线图标和<RX>从属单元图标, 短按<



MENU>按钮进入自定义菜单, 将<CH>频道设置按钮设置同引闪器相同频道, 按<Gr>组别设置按钮设置同引闪器相同组别。

(注: 其他型号机顶闪光灯设置请根据相应的机顶灯使用说明书)

4. 按下相机快门即可引闪, 同时引闪器“状态指示灯”闪亮红色。

无线同步触发外拍闪光灯

使用方法: 以AD600Pro为例:

1. 关闭相机电源, 将引闪器放置于相机热靴插座上, 打开引闪器电源开关和相机电源。
2. 短按<MENU>按键进入自定义菜单, 设置引闪器频道、组别。短按<MODE.LOCK>按键设置引闪器模式, 拨动转盘设置引闪器档位参数(请看设置引闪器详细介绍)。
3. 启动外拍闪光灯电源, 短按无线设置按钮, 令屏幕显示无线图标, 长按<GR/CH>组别频道按键设置按钮, 设置同引闪器相同频道, 短按<GR/CH>组别设置按钮设置同引闪器相同组别。
(注: 其他型号外拍闪光灯设置请根据相应的外拍闪光灯使用说明书)
4. 按下相机快门即可引闪, 同时引闪器“状态指示灯”闪亮红色。



无线同步触发影室闪光灯

使用方法以QTIH为例:

1. 关闭相机电源, 将引闪器放置于相机热靴插座上, 打开引闪器电源开关和相机电源。
2. 短按<MENU>按键进入自定义菜单, 设置引闪器频道、组别。短按<MODE.LOCK>按键设置引闪器模式, 拨动转盘设置引闪器档位参数(请看设置引闪器详细介绍)。
3. 将影室闪光灯接上电源, 打开电源开关, 按MODE/无线按键, 令屏幕显示无



线图标, 此时进入2.4G无线状态。 , 长按<GR/CH>组别频道设置按钮设置同引闪器相同频道, 短按<GR/CH>组别频道设置同引闪器相同组别。

注: 其他型号影室闪光灯设置请根据相应影室闪光灯使用说明书。

- 按下相机快门即可引闪, 同时影室灯与触发器“状态指示灯”呈现闪亮红色状态。

注: 影室闪光灯最小输出值为1/32, 引闪器设置输出值时应设置 $\geq 1/32$ 的数值。影室闪光灯无TTL和频闪功能, 故引闪器设置时选M模式才能触发影室闪光灯。

电源开关

将电源开关拨至“ON”即可打开电源, 状态指示灯不显示。

注意: 长时间不使用时, 请关闭电源以免耗电!

省电模式设置

- 在停止操作引闪器超过设置时间 (60 秒/30 分钟/60 分钟) 后, 系统自动进入待机模式, 此时LCD显示消失。

注意: 睡眠时间可以在MENU-STBY中调节。

- 唤醒休眠系统, 可以按任意键。

注: 若不想设置省电模式, 短按<MENU>按键进入自定义菜单, 将STBY设置为OFF即可。

AF对焦辅助灯开关

将AF辅助对焦灯开关拨至“ON”, 允许输出AF对焦光线。

相机无法对焦时, 对焦灯会自动点亮; 相机正常对焦时, 对焦灯会自动熄灭。

频道设置

- 短按<MENU>按键, 进入自定义功能菜单。
- 拨动转盘至<☎>, 短按<SET>按键进入无线设置, 接着拨动转盘至<CH>频道, 然后短按<SET>按键进入<CH>频道设置界面。此时拨动转盘可选择

1-32个频道, 选择完毕, 短按<SET>按键退出<CH>频道设置。

注意: 使用前请务必将引闪器和接收端置于相同频道。

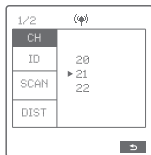

无线ID设置

除了通过改变无线传输频道避免拍摄干扰, 还可以通过改变无线ID号来避免拍摄干扰。主控单位和从控单位无线ID、频道都要一致才能触发。

- 短按<MENU>按键, 进入自定义功能菜单。转动功能选择转盘至<☎>, 再短按<SET>按键进入无线设置, 接着拨动转盘选至<ID>, 短按<SET>按键进入ID号设置界面。此时转动转盘可选择OFF/1-99, 选择完毕, 短按<SET>按钮退出<ID>设置。

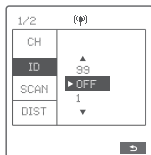

扫描空闲频道设置

为了避免其他人使用与自己一样的频道, 提高拍摄无关干扰性, 可以使用扫描空闲频道功能。短按MENU按键进入菜单, 旋转转盘选中<☎>, 短按SET按键进入无线设置, 旋转转盘选中SCAN选项。短按SET按键进入SCAN设置界面, 选择转盘选中START, 最后短按SET按键, 即可显示会5%到100%扫描, 扫描完成后会出现8组空闲频道。

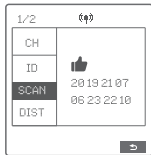

模式设置

短按组别按键选中组别，短按<MODE.LOCK>按键，选中的组别模式会发生变化。

当菜单中<Ⓜ>--GROUPS (组别) 设置为5 (A-E) (5组组别) 且<Ⓜ>为开启 (ON) 时:

1. 多组模式显示时，短按<MODE.LOCK>按键，多组显示模式可以切换为MULTI模式，此时短按组别选择按键选中某组组别，短按<MODE.LOCK>按钮将该组MULTI模式设为打开“ON”或关闭“-”。短按一次<MODE.LOCK>按键可退出MULTI模式。
2. 多组模式显示时，短按组别选择按键选中某组组别，短按<MODE.LOCK>按钮可将当前组模式在TTL/M/--模式下顺序切换。
3. 单组模式显示，短按<MODE.LOCK>按钮将当前组模式在TTL/M/OFF模式下顺序切换。

当菜单中<Ⓜ>--GROUPS (组别) 设置为16 (0-F) (16组组别) 时:

- 多组模式显示和单组模式显示，都仅有M手动模式。

长按2秒<MODE.LOCK>按键，屏幕的下方出现“LOCKED”字母，表示当前屏幕已被锁定，此时不能再设置任何参数，再次长按2秒<MODE.LOCK>按键方可解锁。

放大功能

多组显示和单组显示切换: 在多组模式下短按组别按键选定组别，短按<Ⓜ>按键，组别放大到单组显示模式，短按<Ⓜ>按键可返回多组显示模式。

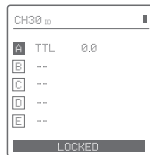
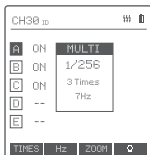

档位值设置 (功率设置)

多组显示时，在M模式下

1. 短按组别按钮选中组别，拨动功能选择转盘，其功率输出值将在Min.~1/1或Min.~10之间变化，每档都以0.1档或1/3档为增量。最后短按<SET>按键确定该组功率输出值。
2. 短按功能按键1 (ALL按键) 全组功率输出值会被选中，拨动功能选择转盘，其功率输出值将在Min.~ 1/1或Min.~10 之间变化，且每档以0.1档或1/3档为增量，最后短按功能按键1 (ALL按键) 确定全组功率输出值。

单组显示时，在M模式下

1. 直接拨动功能选择转盘，其功率输出值将在Min.~ 1/1 之间变化，每档都以0.1档或1/3档为增量。

注: Min. 指M或Multi模式下能设置的最小输出值。根据MENU-STEP的设置值的不同，Min. 值不同。最小功率输出档位 (STEP) 选择一共有9种，分别为 1/128 0.3、1/256 0.3、1/512 0.3、1/128 0.1、1/256 0.1、1/512 0.1、3.0 (0.1)、2.0 (0.1)、1.0 (0.1)。在大多数机顶灯上，支持的最小输出是 1/128或1/128(0.1)，无法设置到 1/256或1/256(0.1); 配合神牛公司的AD600Pro等大功率的影室灯，可以调节最小输出到1/256或1/256(0.1)。

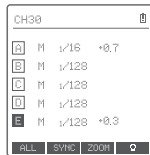

曝光补偿设置

多组显示时，在TTL模式下

1. 短按组别按钮选中组别，拨动功能选择转盘，其FEC值在-3~3之间以0.3为增量，短按<SET>按键确定该组FEC值。
2. 短按功能按键1 (ALL按键)，全组FEC值会被选中，拨动功能选择转盘，其FEC值在-3~3之间以0.3为增量，再次短按功能按键1 (ALL按键) 确定全组FEC值。

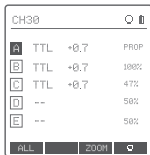

单组显示时, 在TTL模式下

1. 直接拨动功能选择转盘, 其 FEC 值在 -3 ~ 3 之间以 0.3 为增量。



频闪参数值设置(输出值、次数、频率)

设置频闪参数前提: 菜单<(P)>-GROUPS需选中5 (A-E), 且菜单频闪需选ON (开启)。在多组显示下, 短按<MODE.LOCK>按键进入频闪参数值设置界面。

1. 在频闪模式下(TTL和M图标都不会显示)。
2. 三行显示内容分别为功率输出值(Min ~ 1/4), Times(闪光次数), Hz(闪光频率)。
3. 拨动转盘, 其功率输出值将在Min ~ 1/4 之间以整档变化。
4. 短按功能按键1(TIMES按键), 拨动功能选择转盘调整闪光次数。
5. 短按功能按键2 (HZ按钮), 拨动功能选择转盘调整闪光频率。
6. 设置任意项目或三项设置值设置完毕, 短按<MODE.LOCK>按键, 将退出频闪参数值设置界面。

*注意: 闪光次数受闪光输出值和频率联合制约, 设置的闪光次数不能超过系统允许的上限值。传输到接收端的次数是实际闪光次数, 照相机的快门设置相关。

注: Min. 指M或Multi模式下能设置的最小输出值, 根据MENU-STEP 的设置值的不同, Min. 值不同。最小功率输出档位 (STEP) 选择一共有9种, 分别为 1/128 0.3、1/256 0.3、1/512 0.3、1/128 0.1、1/256 0.1、1/512 0.1、3.0 (0.1)、2.0 (0.1)、1.0 (0.1)。

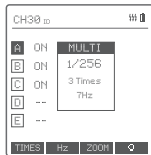

造型灯设置

1. 多组显示时, 短按功能按键4, 实现多组造型灯打开或关闭。
2. 多组显示时, 短按组别按钮选中组别。短按功能按键4, 可切换该组造型灯状态, 一共3种状态: 关闭(--) 或百分比数值(10%-100%)或PROP (自动模式, 随着闪光灯亮度而发生变化)。

造型灯处于百分比数值状态时, 长按功能按键4进入造型灯亮度值设置界面, 旋转功率选择转盘选择所需造型灯百分比数值。单组显示时, 与上述多组显示操作同理。

(注: 目前可以使用单组造型灯开关的影视闪光灯型号如下: GSII, SKII, SKIIV, QSII, QDII, DEII, DPII 系列, DPIII 系列, 此外, 外拍灯 AD200、AD600 系列升级后可使用此功能。以后新出的含造型灯的闪光灯都能用此项功能)。

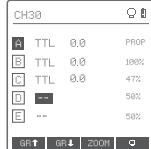

ZOOM值设置

短按功能按键3, 显示屏出现ZOOM值, 短按组别按键选中要更改的组别, 拨动功能选择转盘, ZOOM值会在AUTO/24-200中变化, 选中需要设定的ZOOM值, 最后短按功能按钮3返回主界面。

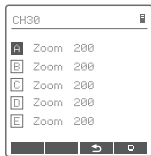

蜂鸣器设置

短按<MENU>按键进入自定义功能菜单, 转动功能选择转盘至< [喇叭图标] >, 再按<SET>按键进入蜂鸣器界面, 转动选择转盘, 可选择开启<ON>或者关闭<OFF>。最后短按<MENU>按键返回主菜单。选择<ON>时, 蜂鸣器启动。选择OFF时, 蜂鸣器关闭。

PC插孔设置

短按<MENU>按键进入自定义功能菜单，转动功能选择转盘至<PC>，再短按<SET>按键进入PC插孔设置，转动功能选择转盘选择IN或OUT，最后短按<MENU>按键返回主菜单。

选择IN时，相机触发发射器。

选择OUT时，发射器触发闪光灯。



SHOOT功能设置

短按<MENU>按键进入自定义功能菜单，转动功能选择转盘至<SHOOT>，再短按<SET>按键进入SHOOT功能设置，转动功能选择转盘选择单拍/多拍/L-858，最后短按<MENU>按键返回主界面。

单拍：相机拍照时选择单拍，在M和Multi模式下，主控单元只对从控单元发送引闪信号，适合单人拍摄时选用，优点省电。

群拍：相机拍照时选择群拍，主控单元会将参数和引闪信号发送至从控单元，适合多人拍摄时选用，此功能耗电快。

L-858：使用L-858测光表直接设置闪光灯数据，发射器只发射同步信号。

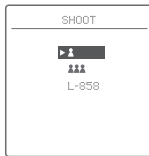

蓝牙设置

蓝牙 MAC 码查看：短按 MENU 按键进入菜单自定义界面，旋转 SET 转盘选择(⌘)，接着短按一次 SET 按键进入蓝牙设置界面，蓝牙 MAC 码显示在右下角。

蓝牙重置：短按 MENU 按键进入菜单自定义界面，旋转 SET 转盘选择(⌘)，接着短按 SET 按键进入蓝牙设置界面，旋转 SET 转盘选择"RESET"，短按 SET 按键进入选择界面，旋转 SET 转盘选择"RESET"；再次短按 SET 按键进入确认界面，旋转 SET 转盘选择"OK"，最后短按 SET 按键即可蓝牙重置，重置完毕，自动返回上一级设置界面。

APP下载

直接扫二维码即可下载“Godox Flash”手机APP。(安卓和苹果系统都可以使用)



具体操作请参考手机APP“使用办法”，里面有详情教程。

注：首个移动设备(手机或平板电脑)可直接使用APP操控灯体。更换其他移动设备(手机或平板电脑)时，灯体需进行蓝牙重置后，方可正常使用APP连接。

蓝牙初始密码统一为：000000。

MENU:自定义菜单

请对照以下本机应用栏, 使用自定义功能完成设置。

自定义符号	功能	设置符号	设置说明
Ⓜ	无线	CH	32组: 1-32
		ID	OFF: 关闭 1-99: 可以选择01-99
		SCAN	OFF:关闭 START:开始扫描空闲频道
		DIST	1-100m:1-100m引闪 0-30m:0-30m引闪
		GROUPS	5(A-E): 5组组别 16 (0-F):16组组别
Ⓜ	蓝牙	BLUE.T	OFF:关闭蓝牙 ON:启动蓝牙
		RESET	CANCEL:取消操作 RESET:重置蓝牙

自定义符号	功能	设置符号	设置说明
Ⓜ	频闪	ON	启动频闪
		OFF	关闭频闪
DELAY	高速同步 延时	OFF	关闭高速同步延时
		0.1ms-9.9ms	0.1ms-9.9ms: 高速同步延 时范围
STEP	档位	1/128 0.3	最小输出档位1/128(每档以1/3 档为增量)
		1/256 0.3	最小输出档位1/256(每档以1/3 档为增量)
		1/512 0.3	最小输出档位1/512(每档以1/3 档为增量)
		1/128 0.1	最小输出档位1/128(每档以0.1 为增量)
		1/256 0.1	最小输出档位1/256(每档以0.1 为增量)
		1/512 0.1	最小输出档位1/512(每档以0.1 为增量)
		3.0 (0.1)	最小输出档位3.0 (每档以0.1为 增量)
		2.0 (0.1)	最小输出档位2.0 (每档以0.1为 增量)
		1.0 (0.1)	最小输出档位1.0 (每档以0.1为 增量)

自定义符号	功能	设置符号	设置说明	
SHOOT		单拍	相机拍照时在M&Multi模式下只发送引闪信号	
		群拍	相机拍照时发送参数和引闪信号(适合多人拍摄)	
	使用L-858	L-858	使用 L-858 测光表直接设置闪光灯数据,发射器只发射同步信号。	
TCM	TCM转换功能	OFF	关闭TCM转换功能	
			TT685II/V860III系列	
		100j	AD100Pro	使TTL拍摄值转换为M输出值,混用时以主灯型号为准。TCM转换功能开启后,短按<MODE.LOCK>按键可进行TCM转换。
		200j	AD200	
		300j	AD300Pro	
		360j400j	AD400Pro	
		600j	AD600,AD600Pro	
		1200j	AD1200Pro	
	传统热靴	OFF	关闭传统热靴	
		ON	启动传统热靴,不能使用TTL闪光,无高速同步功能	

自定义符号	功能	设置符号	设置说明
	试闪按键	TRIGGER	触发器试闪
		SHUTTER	快门试闪
PC	PC端口	IN	输入端,相机触发发射器
		OUT	输出端,发射器触发闪光灯
	蜂鸣器	OFF	关闭蜂鸣器
		ON	启动蜂鸣器
	睡眠	60 sec	60秒没有人操作,进入睡眠模式
		30 min	30分钟没有人操作,进入睡眠模式
		60 min	60分钟没有人操作,进入睡眠模式
		OFF	关闭睡眠功能
LIGHT	背光	12sec	12秒无操作,自动熄灭LCD和按键背光
		OFF	关闭LCD和按键背光
		ON	一直启动LCD和按键背光
	LCD对比度	-3-+3	对比度值范围: -3到+3之间的整数

自定义符号	功能	设置符号	设置说明
USER	使用预设	SAVE	保存组: 1-5
		LOAD	导入组: 1-5
CLEAR	清除数据功能	CANCEL	取消
		CLEAR	清除菜单数据

注: 短按<  >对应的功能按键4可返回上一级设置。

兼容闪光灯型号

发射器	接收器	闪光灯型号
XPROIIL	---	V860III系列、V1系列、AD100Pro、AD200、AD200Pro、AD300Pro、AD400Pro、AD600Pro、AD1200Pro、P2400 备注1: 以上闪光灯的固件需要支持XProIIL引闪器。 闪客III系列影室闪光灯 备注2: 以上型号闪光灯固件版本必须在V1.5或以上才能支持XProIIL引闪器高速同步引闪。

注: 支持的功能范围: XProIIL和闪光灯双方都拥有的功能。

兼容相机列表

本机可兼容以下徕卡相机型号:

SL2	SL	M10	CL	Q2
-----	----	-----	----	----

1. 此表格仅列举目前已测试的相机型号, 未涵盖所有徕卡相机。其他相机型号, 用户可自行测试。
2. 本公司保留未来修改此表格内容的权利。

▲ 警告: 用于某些机型时, 高速同步闪光画面出现亮边。
用于某些机型时, 快速连续拍摄会出现漏闪情况。

规格参数

型号	XPROIIL
兼容相机	支持徕卡相机 (TTL自动闪光) 支持所有具有 PC 输出出口的相机
供电方式	2*AA电池
曝光控制	
TTL自动闪光	具备
手动闪光	具备
频闪闪光	具备
功能	
高速同步	有 (相机上设置)
后帘同步	有 (相机上设置)
曝光补偿	±3EV (曝光值), 以1/3 EV为增量调节
曝光锁定	具备
辅助对焦	具备
造型闪光	可以通过触发器控制闪光灯造型闪光
蜂鸣器	可以通过触发器控制闪光灯蜂鸣器
无线快门	接收器端可以通过2.5mm同步接口控制相机拍摄

ZOOM设置	可以通过发射器调节闪光灯焦距值。可选择: AUTO, 24-200
TCM	使TTL拍摄值转换为M输出值
固件更新	通过身上的USB Type-C 口进行固件升级
记忆功能	设置2秒后的参数会自动记忆, 重新开机自动恢复
显示屏	宽屏液晶显示, 可开启或关闭背光
无线闪光	
传输范围 (约)	0-100米
内置无线	2.4GHz
调制方式	MSK
频道	32个
无线ID	01-99
组别	16组
规格	
尺寸	95mm*62mm*49mm
净重	93g

恢复出厂设置

同时按住中间两个功能按键 **2 秒**, 屏幕出现 RESET, 下方有 CANCEL 和 OK 两个选项, 旋转 SET 转盘选择 OK, 短按 SET 按钮, 自动返回主界面表示已恢复出厂设置。

固件升级

本机通过 USB 口可进行固件升级, 软件最新公告及说明将会发表在官方网站上。

注: 本品出厂不配 USB 升级线, 请另行购买。本产品 USB 口为 USB Type-C 接口, 请使用 USB Type-C 线。产品升级固件需要 Godox G3 程序软件支持, 升级固件前请先下载安装“Godox G3 固件升级软件”再选择相应的固件文件。由于产品进行固件升级, 说明书请以最新电子版为准。

注意事项

1. 如不能正确引闪或拍摄, 请检查电池是否正确安装以及是否打开引闪器电源; 引闪器是否设置在同一频道; 连接线或热靴口是否已正确牢固连接到位; 功能模式是否正确。
2. 如相机出现只能拍摄不能对焦现象, 请检查机身或镜头是否设定为 MF 手动对焦, 请设置为 Af 自动对焦。
3. 如您的引闪器受到他人干扰引闪或拍摄, 改变引闪器的频道设置即可。

神牛2.4G无线漏闪原因及解决办法:

1. **外部环境 2.4G 信号干扰 (如无线基站、2.4Gwifi 路由、蓝牙设备等)**
请调节引闪器的频道 CH 设置 (建议 +10) 找到无干扰的频道来工作, 或者在工作时关闭其他 2.4G 设备。
2. **请确认闪光灯是否已经回电或者回电速度已经跟上连拍速度 (闪光灯就绪指示灯已经亮起), 并且没有处于过热保护或者其他异常状态中**
请下调闪光灯的档位, 如是 TTL 模式可以尝试改为 M 模式 (TTL 模式下需要预闪一次)。
3. **是否引闪器和闪光灯距离太近 (距离 <0.5m)**
请在引闪器上打开“近距离无线模式”; 设置 MENU- (P) -DIST 为 0-30m。
4. **是否引闪器和接收端设备在低电状态请更换电池**
(引闪器电池建议使用 1.5V 一次性碱性电池)

引闪器保养

避免跌落: 如果受到强烈碰撞或振动, 引闪器可能会发生故障。

保持干燥: 本产品是非防水产品, 如果将其浸入水中或放置于高湿度的环境中将可能发生故障。内部构造生锈可能会导致无法修理。

避免温度骤变, 诸如在寒冷天进出温暖的大楼将可能会使引闪器内部结露。为避免结露, 请将引闪器事先装入手提袋或塑料包内, 以防温度突变。

远离强磁场: 无线电广播发射机等设备产生的强静电或强磁场可能会干扰本产品正常工作。

Contents

Foreword	24	Modeling Lamp Settings	34
Warning	24	ZOOM Value Settings	34
Names of Parts	25	Buzz Settings	35
Body	25	PC Socket Settings	35
LCD Panel	26	SHOOT Function Settings	35
Battery Installation	27	Bluetooth Settings	36
Battery Level Indication	27	APP Downloading	36
As a Wireless Camera Flash Trigger	27	MENU: Setting Custom	
As a Wireless Outdoor Flash Trigger	28	Functions	37
As a Wireless Studio Flash Trigger	28	Compatible Flash Models	41
Power Switch	29	Compatible Camera Models	42
Power Saving Mode Settings	29	Technical Data	42
Power Switch of AF Assist Beam	30	Restore Factory Settings	43
Channel Settings	30	Firmware Upgrade	44
Wireless ID Settings	30	Attentions	44
Scanning Spare Channel Settings	31	Caring for Flash Trigger	45
Mode Settings	31		
Magnification Function	32		
Output Value Settings (Power Settings)	32		
Flash Exposure Compensation Settings	33		
Multi Flash Settings (Output Value, Times and Frequency)	33		

Foreword

Thank you for purchasing this XProLIL wireless flash trigger.

This wireless flash trigger applies for using Leica camera to control GODOX flash, controls the flashes with built-in Godox wireless X system e.g. camera flashes, outdoor flashes, and studio flashes. Featuring multi-channel triggering, stable signal transmission and quick response, this flash trigger benefits photographers for flexible light distribution and various shooting demands, which is suitable for hotshoe-mounted Leica cameras and cameras with PC synchronous socket. The flash trigger supports TTL flash and high-speed flash synchronization, and the maximum flash synchronization speed is up to 1 / 8000s.

* 1/8000s is achievable when the camera has a max camera shutter speed of 1/8000s.

▲ Warning

- ▲ Do not disassemble. Should repairs become necessary, this product must be sent to an authorized maintenance center.
- ▲ Always keep this product dry. Do not use in rain or in damp conditions.
- ▲ Keep out of reach of children.
- ▲ Do not use the flash unit in the presence of flammable gas. In certain circumstance, please pay attention to the relevant warnings.
- ▲ Do not leave or store the product if the ambient temperature reads over 50°C.
- ▲ Turn off the flash trigger immediately in the event of malfunction.
- ▲ Observe precautions when handling batteries
 - Use only batteries listed in this manual. Do not use old and new batteries or batteries of different types at the same time.
 - Read and follow all warnings and instructions provided by the manufacturer.
 - Batteries cannot be short-circuited or disassembled.
 - Do not put batteries into a fire or apply direct heat to them.
 - Do not attempt to insert batteries upside down or backwards.
 - Batteries are prone to leakage when fully discharged. To avoid damage to the product, be sure to remove batteries when the product is not used for a long time or when batteries run out of charge.
 - Should liquid from the batteries come into contact with skin or clothing, rinse immediately with fresh water.

Names of Parts

Body

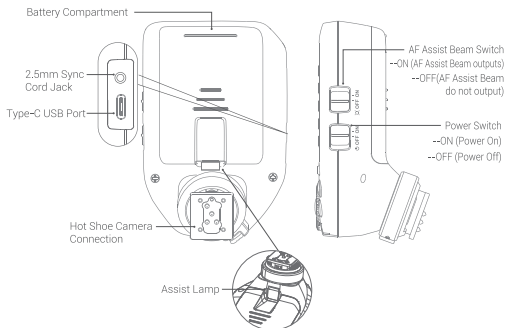
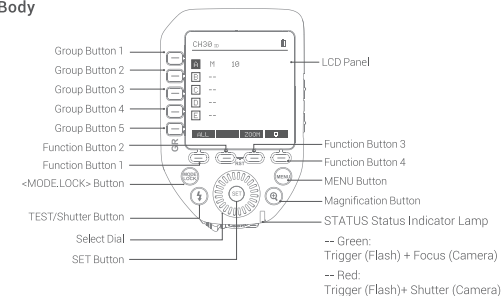

LCD Panel

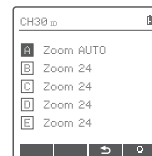
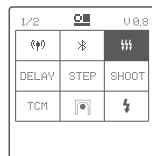
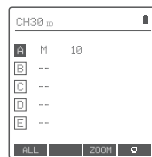
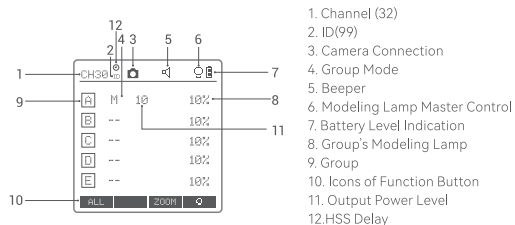





Battery Installation

Slide the battery compartment lid of the flash trigger and insert two AA batteries (optional) separately.

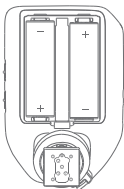
Battery Level Indication

Check the battery level indication on the LCD panel to see the remaining battery level during the usage.



Battery Level Indication	Power Status
3 grids 	Full
2 grids 	Middle
1 grid 	Low
Blank grid 	Low power , please replace it.
Blinking	2.5V The battery level is going to be used out immediately (please replace new batteries, as low power leads to no flash or flash missing in case of long distance).

The battery indication only refers to AA alkaline batteries. As the voltage of Ni-MH battery tends to be low, please do not refer to this chart.

As a Wireless Camera Flash Trigger

Take V1 series camera flash as an example:

1. Turn off the camera and mount the transmitter on camera hotshoe. Then, power on the flash trigger and the camera.
2. Short press the < MENU > Button to enter the C.Fn. menu, turn the Select Dial to < wireless function > and press the < SET > Button to set groups, mode and other parameters.



3. Turn on the camera flash, press the wireless setting button and the wireless icon and <RX> icon will be displayed on the LCD panel. Short press the < MENU > Button to enter the C.Fn. menu, press the <CH> button to set the same channel to the flash trigger, and press the <Gr> button to set the same group to the flash trigger. (Note: please refer to the relevant instruction manual when setting the camera flashes of other models)
4. Press the camera shutter to trigger and the status lamp of the flash trigger turns red synchronously.

As a Wireless Outdoor Flash Trigger

Take AD600Pro as an example:

1. Turn off the camera and mount the transmitter on camera hotshoe. Then, power on the flash trigger and the camera.
2. Short press the < MENU > button to enter the C. Fn Menu to set channel and group. Short press <MODE.LOCK> button to set flash trigger mode, turn the select dial to set flash trigger level. (refers to the contents of "Setting the Flash Trigger")
3. Power on the outdoor flash and press the wireless setting button and the wireless icon will be displayed on the LCD panel. Long press the <GR/CH> button to set the same channel to the flash trigger, and short press the < GR/CH> button to set the same group to the flash trigger (Note: please refer to the relevant instruction manual when setting the outdoor flashes of other models).
4. Press the camera shutter to trigger and the status lamp of the flash trigger turns red synchronously.



As a Wireless Studio Flash Trigger

Take QTIII as an example:

1. Turn off the camera and mount the transmitter on camera hotshoe. Then, power on the flash trigger and the camera.



- Short press the < MENU > button to enter the C. Fn Menu to set channel and group. Short press <MODE.LOCK> button to set flash trigger mode, turn the select dial to set flash trigger level. (refers to the contents of "Setting the Flash Trigger")
- Connect the studio flash to power source and power it on. Long press the MODE/Wireless button to make the wireless icon displayed on the panel and enter 2.4G wireless mode. Long press the <GR/CH> button to set the same channel to the flash trigger, and short press the < GR/CH > button to set the same group to the flash trigger (Note: please refer to the relevant instruction manual when setting the studio flashes of other models).
- Press the camera shutter to trigger. And the status lamp of the camera flash and the flash trigger both turn red synchronously.
 Note: As the studio flash's minimum output value is 1/32, the output value of the flash trigger should be set to or over 1/32. As the studio flash do not have TTL and stroboscopic functions, the flash trigger should be set to M mode in triggering.

Power Switch

Slide the Power Switch to ON, and the device is on and status indicator lamp will not reveal.

Note: In order to avoid power consumption, turn off the transmitter when not in use.

Power Saving Mode Settings

- The system will automatically enter standby mode after 60sec/30min/60min of idle use. And the displays on the LCD panel will disappear.
 Note: Dormancy time is adjustable in MENU-STBY.
- Press any button to wake up. If the flash trigger is attached to the hot shoe of CANON EOS camera, half press the camera shutter can also wake the system up.
 Note: If you don't want to set the power saving mode, press < MENU > Button to enter the C. Fn Menu and set STBY to OFF.

Power Switch of AF Assist Beam

Push the AF Assist Beam Switch up to ON, and the AF lighting is allowed output. When the camera cannot focus, the AF assist beam will turn on; when the camera can focus, the AF assist beam will turn off.

Channel Setting

- Short press the < MENU > Button to enter the C. Fn
- menu. Turn the Select Dial to select- (☺) > and press the < SET > Button to the setting page to select CH and press <SET> button to enter channel settings. Turn Select Dial to select 1-32 channels, then short press <SET> button to exit from channel settings.

Notes: please set the transmitter and the receiver to the same channel before usage.

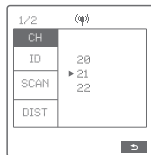

Wireless ID Settings

In addition to changing the wireless transmission channel to avoid interference, we can also change the wireless ID to avoid interference.

Note: the wireless ID and channel of lead control unit and follow control unit must be consistent before triggering.

Short press the < MENU > Button to enter the C. Fn menu. Turn the Select Dial to select- (☺) > and press the < SET > Button to the setting page, turn Select Dial to ID and short press <SET> Button to enter ID settings. Turn Select Dial to select OFF/1-99, and then short press <SET> to exit form ID settings.

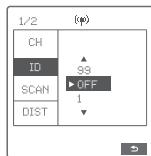

Scanning Spare Channel Settings

Scanning spare channel function is useful to avoid interference from others' using the same channel. Short press the < MENU > button to enter the Menu, turn the select dial to choose < (P) >, short press the SET button to enter the wireless setting, then turn the select dial to choose SCAN option. Short press the SET button to enter the SCAN setting interface, turn the select dial to choose START, then short press the SET button to scan from 5% to 100%, and 8 groups of spare channels will be displayed.

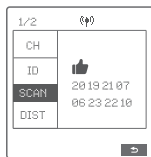

Mode Setting

Short press the group button to choose group, then short press <MODE,LOCK> button, the mode of the chosen group will change.

Set the groups to five groups (A-E) and (MULTI) is (ON):

- When displaying multiple groups, press the <MODE,LOCK > button to switch the multi-group mode to MULTI mode. Press the group selection button to choose a group, short press <MODE,LOCK > button can set the MULTI mode to ON or OFF, short press it once can exit MULTI mode.
- When displaying multiple groups, press the group selection button to choose a group, short press <MODE,LOCK > button, and all the current group's mode will be changed by the order of TTL/M/--.
- When displaying single group, short press <MODE,LOCK > button, and the current group's mode will be changed by the order of TTL/M/OFF.

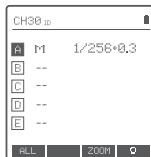

Set the groups to 16 groups (0-F):

When displaying multiple groups or single group, there is only manual mode M.

Long press the <MODE,LOCK > button for 2 seconds until "LOCKED" is displayed on the bottom of the LCD panel, which means the screen is locked and no parameters can be set. Long press the <MODE,LOCK > button again to unlock.

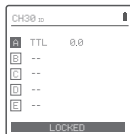

Magnification Function

Switch between multi-group and one-group mode: choose a group in multi-group mode and press the < (Q) > button to magnify it to one-group mode. Then, press the < (R) > button to back to multi-group.

Output Value Settings (Power Settings)

Multi-group displays in the M mode

- Press the group button to choose the group, turn the select dial, and the power output value will change from Min. to 1/1 or Min. to 10 in 0.3 or 1/3 stop increments. Then, press <SET> Button to exit from this setting.
- Press Function Button 1 (<ALL> button) to choose all groups' power output value, turn the select dial, and all groups' power output value will change from Min to 1/1 or Min. to 10 in 0.3 or 0.1 stop increments. Press Function Button 1 (<ALL> button) again to confirm the setting.

One-group displays in the M mode

- Turn the select dial and the group's power output value will change from Min to 1/1 in 0.3 or 0.1 stop increments.

Note: Min. refers to the minimum value that can be set in M or Multi mode. The minimum value can be set to 1/128 0.3, 1/256 0.3, 1/512 0.3, 1/128 0.1, 1/256 0.1, 1/512 0.1, 3.0 (0.1), 2.0 (0.1) and 1.0 (0.1) according to MENU-STEP. For most of camera flashes, the minimum output value is 1/128 or 1/128(0.1) and cannot be set to 1/256 or 1/256 (0.1). However, the value can change to 1/256 or 1/256(0.1) when using in combination with Godox strong power flashes e.g. AD600Pro, etc.

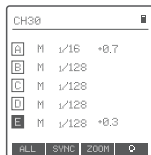

Flash Exposure Compensation Settings

Multi-group displays in the TTL mode

1. Press the group button to choose the group, turn the select dial, and the FEC value will change from -3 to ~3 in 0.3 stop increments. Press the <SET> button to confirm the setting.
2. Press Function Button 1 (<ALL> button) to choose all groups' FEC value, turn the select dial, and all groups' FEC value will change from -3 to 3 in 0.3 stop increments. Press Function Button 1 (<ALL> button) again to confirm the setting.

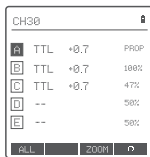

One-group displays in the TTL mode

1. Turn the select dial and the group's power output value will change from -3 to 3 in 0.3 stop increments.

Multi Flash Settings (Output Value, Times and Frequency)

Conditions for setting the multi flash parameters: 5 (A-E) should be selected in the menu <GROUPS>, and multi flash should be turned on.

When displaying multiple groups, short press the <MODE.LOCK> button to enter multi flash setting interface.

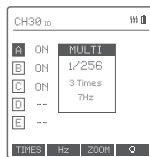

1. In the multi flash (TTL and M icon are not displayed).
2. The three lines are separately displayed as power output value (1/128~1/4), Times (flash times) and Hz (flash frequency).
3. Turn the Select Dial to change the power output value from 1/128 to 1/4 in integer stops
4. Short press the Function Button 1 (TIMES button) can change flash times. Turn the select dial to change the setting value.
5. Short press the Function Button 1 (HZ button) can change flash frequency. Turn

the select dial to change the setting value.

6. Until any value or three values are set, short press the <MODE.LOCK> button to exit the setting status.

Note: As flash times are restricted by flash output value and flash frequency, the flash times cannot surpass the upper value that permitted by the system. The times that transported to the receiver end are a real flash time, which is also related to the camera's shutter setting.

Note: Min. refers to the minimum value that can be set in M or Multi mode. The minimum value can be set to 1/128 0.3, 1/256 0.3, 1/128 0.1, 1/256 0.1, 1/512 0.1, 3.0 (0.1), 2.0 (0.1) and 1.0 (0.1) according to MENU-STEP.

Modeling Lamp Settings

1. When displaying multiple groups, press the Function Button 4 button to control the ON/OFF of the modeling lamp.
2. Press the group button to choose the group when displaying multiple groups, press the Function Button 4 button to control the status of the modeling lamp: OFF (--), Percentage value (10%-100%) or PROP (auto mode, changes with the flash brightness)

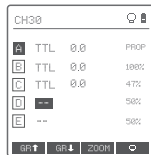

When the modeling lamp is in the percentage value status, long press the Function Button 4 to enter the modeling lamp brightness value setting interface, and turn the select dial to select the desired modeling lamp percentage value.

When displaying a single group, it is the same as the above-mentioned multiple groups display operation.

(note: The models that can use one-group to ON/OFF the modeling lamp are as follows: GSII, SKII, QSII, QDII, DEII, DPII series, etc. The outdoor flash AD200 and AD600 can use this function after upgrade. The new arrivals with modeling lamps can also use this function.).

ZOOM Value Settings

Short press the Function Button 3 and the ZOOM value will be displayed on the LCD panel. Choose the group and turn the select dial, and the ZOOM value will change from AUTO/24 to 200. Choose the desired value and long press the Function Button again to back to the main menu.

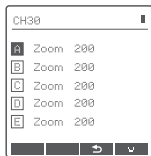

Buzz Settings

Press the < MENU > Button to enter the C, Fn menu, turn the Select Dial to <  >, press the < SET > Button to enter and turn the Select Dial to select ON/OFF turned on or off.

Then press the < MENU > Button return to the main menu.

When choosing ON, the beeper is turned on.

When choosing OFF, the beeper is turned off.

PC Socket Settings

Press the <MENU> button to enter C.Fn menu, turn the select dial to <PC>, and press the <SET> button to enter

PC socket setting to choose IN or OUT. Press the

<MENU> button again to back to the main menu.

When choosing IN, it will enable XProILL to trigger flash.

When choosing OUT, it will send trigger signals to trigger other flash.



SHOOT Function Settings

Press the < MENU > Button to enter the C.Fn menu and turn

the Select Dial to select <SHOOT>, then short press the <

SET> button and turn Select Dial to select One-shoot/

Multi-shoots/L-858, after that press <MENU> Button return to the main menu.

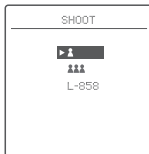

One-shoot: When shooting, choose one-shoot. In the M and Multi mode, the lead unit only sends triggering signals to the follow unit, which is suitable for one person photography for the advantage of power saving.

Multi-shoots: When shooting, choose multi-shoots, and the lead unit will send parameters and triggering signals to the follow unit, which is suitable for multi person photography. However, this function consumes power quickly.

L-858: The flash parameters can be adjusted directly on Sekonic L-858 Light Meter when collocating with it, and the transmitter only transmits SYNC signal.

Bluetooth Settings

Check Bluetooth MAC code: Short press the MENU button to enter the C.Fn menu, turn the select dial to select <  >, then short press the SET button to enter the Bluetooth setting interface, and the Bluetooth MAC code is displayed in the bottom right corner.

Bluetooth Reset: Short press the MENU button to enter the C.Fn menu, turn the select dial to select <  >, then short press the SET button to enter the Bluetooth setting interface, turn select dial to choose "RESET" and short press the SET button to enter "RESET", then you can reset the Bluetooth as you wish. It will automatically return to the previous setting interface after the reset is completed.

APP Downloading

Scan the following QR code to download "Godox Flash" APP. (available for both Android and iOS systems)





For more smartphone APP operations, please open the "help" in the APP to gain detailed guidance.

Note: the APP can be used directly on the firstly installed device (smartphone or tablet). When changing to other mobile device, the light shall be reset before the normal usage of APP.





The Bluetooth initial password is 000000.





MENU: Setting Custom Functions

The following table lists the available and unavailable custom functions of this flash:

Icons	Functions	Setting Icons	Settings and Description
	Wireless	CH	32: 1-32
		ID	OFF: off 1-99: optional 01-99 Choose any figure from 01-99
		SCAN	OFF: off START: Start scanning spare channel
		DIST	1-100m:1-100m triggering 0-30m:0-30m triggering
		GROUPS	5(A-E): 5 groups 16 (0-F):16 groups
	Bluetooth	BLUE.T	OFF: off ON: on
		RESET	CANCEL: cancel RESET: Bluetooth reset

Icons	Functions	Setting Icons	Settings and Description
	Multi flash	ON	Turn on multi flash
		OFF	Turn off multi flash
DELAY	HSS delay	OFF	Turn off HSS delay
		0.1ms-9.9ms	0.1ms-9.9ms: HSS delay range
STEP	Power output value	1/128 0.3	The minimum output is 1/128 (change in 0.3 step)
		1/256 0.3	The minimum output is 1/256 (change in 1/3 step)
		1/512 0.3	The minimum output is 1/512 (change in 1/3 step)
		1/128 0.1	The minimum output is 1/128 (change in 0.1 step)
		1/256 0.1	The minimum output is 1/256 (change in 0.1 step)
		1/512 0.1	The minimum output is 1/512 (change in 0.1 step)
		3.0 (0.1)	The minimum output is 3.0 (change in 0.1 step)
		2.0 (0.1)	The minimum output is 2.0 (change in 0.1 step)
		1.0 (0.1)	The minimum output is 1.0 (change in 0.1 step)

Icons	Functions	Setting Icons	Settings and Description
SHOOT		One-shoot	Only send triggering signals in the M & Multi mode when camera is shooting
		Full-shoot	Send parameters and triggering signal when camera is shooting (suitable for multi person photography)
	Connect to L-858	L-858	The flash parameters can be adjusted directly on Sekonic L-858 Light Meter when collocating with it, and the transmitter only transmits SYNC signal
TCM	TCM transform function	OFF	turn off TCM transform function
			TT685II/V860III series
		100j	AD100Pro
		200j	AD200
		300j	AD300Pro
		360j/400j	AD400Pro
		600j	AD600,AD600PRO
		1200j	AD1200Pro
			Legacy hot shoe
ON	turn on legacy hot shoe, TTL flash is unavailable, HSS function is also unavailable		

Icons	Functions	Setting Icons	Settings and Description
	TEST button	TRIGGER	Trigger testing
		SHUTTER	Shutter testing
PC	PC socket	IN	In port, enable XProIII to trigger flash
		OUT	Out port, send trigger signals to trigger other flash
	Beeper	OFF	turn off Beeper
		ON	turn on Beeper
	Sleep	60 sec	Enter sleep mode after 60 seconds of idle use
		30 min	Enter sleep mode after 30 minutes of idle use
		60 min	Enter sleep mode after 60 minutes of idle use
		OFF	turn off sleep mode
LIGHT	Backlighting	12sec	LCD panel and buttons backlight off in 12 seconds
		OFF	LCD panel and buttons backlight always off
		ON	LCD panel and buttons backlight always lighting
	LCD contrast ratio	-3-+3	The contrast ration can be set as integral number from -3 to +3

Icons	Functions	Setting Icons	Settings and Description
USER	Preset	SAVE	SAVE: 1-5
		LOAD	Import: 1-5
CLEAR	Clear function	CANCEL	CANCEL
		CLEAR	Clear data from menu

Note: Short press the <  > function button 4 to return to the previous setting.

Compatible Flash Models

Transmitter	Receiver	Flash models
XPROIIL	---	V860III Series, V1 Series, AD100Pro, AD200, AD200Pro, AD300Pro, AD400Pro, AD600Pro, AD1200Pro, P2400 Note 1: Firmwares of the above flashes must support XPROIIL. Quicker III Series Studio Flashes Note 2: Firmware versions of the above flashes must be V1.5 or above to support HSS of XPROIIL.

Note: The range of support functions: the functions that are both owned by XPROIIL and flash.

Compatible Camera Models

This flash trigger can be used on the following Leica camera models:

SL2	SL	M10	CL	Q2
-----	----	-----	----	----

- This table only lists the tested camera models, not all Leica EOS series cameras. For the compatibility of other camera models, a self-test is recommended.
- Rights to modify this table are retained.

▲ Caution:

There are shining edges in HSS flash when collocating with certain models.

There are missing flashes in quickly continuous shootings when collocating with certain models.

Technical Data

Model	XPROIIL
Compatible cameras	Leica cameras (TTL autoflash) Cameras that have PC sync socket.
Power supply	2*AA batteries
Flash Exposure Control	
TTL autoflash	Yes
Manual flash	Yes
Stroboscopic flash	Yes
Functions	
High-speed sync	Yes (Set on cameras)
Second- curtain sync	Yes (Set on cameras)
Flash exposure compensation	±3EV(exposure value) , adjustable in 1/3 EV increment
Flash exposure lock	Yes
Focus assist	Yes
Modeling lamp flash	Control the modeling lamp flash by flash trigger
Beeper	Control the Beeper by flash trigger
Wireless Shutter	The receiver end can control the camera shooting through the 2.5mm sync cord jack

ZOOM setting	Adjust the ZOOM value by the transmitter from AUTO or 24 to 200
TCM function	Transform the TTL shooting value into the output value in the M mode
Firmware upgrade	Upgrade through the Type-C USB port
Memory function	Settings will be stored 2 seconds after last operation and recover after a restart
Display	Large LCD panel, backlighting ON or OFF
Wireless Flash	
Transmission range (approx.)	0-100m
Built-in wireless	2.4GHz
Modulation mode	MSK
Channel	32
Wireless ID	01-99
Group	16
Other	
Dimension	95mm*62mm*49mm
Net Weight	93g
2.4G Wireless Frequency Range	2413.0MHz-2464.5MHz
Bluetooth Transmission Frequency	2402.00MHz -2480.00MHz
Max. Transmitting Power	5dbm

Restore Factory Settings

Synchronously press the two function buttons in the middle for 2 seconds, the "RESET" is displayed on the LCD panel with CANCEL and OK options, choose OK and short press SET button, it will automatically return to the main interface after the restore factory settings are finished.

Firmware Upgrade

This flash trigger supports firmware upgrade through the Type-C USB port. Update information will be released on our official website.

Note: USB connection line is not included in this product. As the USB port is a Type-C USB socket, please use Type-C USB connection line.

As the firmware upgrade needs the support of Godox G3 software, please download and install the "Godox G3 firmware upgrade software" before upgrading. Then, choose the related firmware file.

Attentions

1. Unable to trigger flash or camera shutter. Make sure batteries are installed correctly and Power Switch is turned on.

Check if the transmitter and the receiver are set to the same channel, if the hotshoe mount or connection cable is well connected, or if the flash triggers are set to the correct mode.
2. Camera shoots but does not focus. Check if the focus mode of the camera or lens is set to MF. If so, set it to AF.
3. Signal disturbance or shooting interference. Change a different channel on the device.

The Reason & Solution of Not Triggering in Godox 2.4G Wireless

1. **Disturbed by the 2.4G signal in outer environment (e.g. wireless base station, 2.4G wifi router, Bluetooth, etc.)**

→ To adjust the channel CH setting on the flash trigger (add 10+ channels) and use the channel which is not disturbed. Or turn off the other 2.4G equipment in working.
2. **Please make sure that whether the flash has finished its recycle or caught up with the continuous shooting speed or not(the flash ready indicator is lighten) and the flash is not under the state of over-heat protection or other abnormal situation.**

→ Please downgrade the flash power output. If the flash is in TTL mode, please try to change it to M mode (a preflash is needed in TTL mode).

3. Whether the distance between the flash trigger and the flash is too close or not

→ Please turn on the "close distance wireless mode" on the flash trigger (<0.5m):

→ Please set the MENU- (F1) -DIST to 0-30m

4. Whether the flash trigger and the receiver end equipment are in the low battery states or not

→ Please replace the battery (the flash trigger is recommended to use 1.5V disposable alkaline battery).

Caring for Flash Trigger

Avoid sudden drops. The device may fail to work after strong shocks, impacts, or excess stress.

Keep dry. The product isn't water-proof. Malfunction, rust, and corrosion may occur and go beyond repair if soaked in water or exposed to high humidity.

Avoid sudden temperature changes. Condensation happens if sudden temperature changes such as the circumstance when taking the transceiver out of a building with higher temperature to outside in winter. Please put the transceiver in a handbag or plastic bag beforehand.

Keep away from strong magnetic field. The strong static or magnetic field produced by devices such as radio transmitters leads to malfunction.

▲ Warning

Operating frequency: 2412.99MHz – 2464.49MHz(2.4G)/2402MHz – 2480MHz(BT)

Maximum EIRP Power: 2,55dBm/1,11dBm

Declaration of Conformity

GODOX Photo Equipment Co., Ltd. hereby declares that this equipment are in compliance with the essential requirements and other relevant provisions of Directive 2014/53/EU. In accordance with Article 10(2) and Article 10(10), this

product is allowed to be used in all EU member states. For more information of DoC, Please click this web link:

<https://www.godox.com/eu-declaration-of-conformity/>

The device complies with RF specifications when the device used at 0mm from your body.

FCC Statement

This device complies with part 15 of the FCC Rules. Operation is subject to the following two conditions:

(1) This device may not cause harmful interference, and

(2) this device must accept any interference received, including interference that may cause undesired operation.

Any Changes or modifications not expressly approved by the party responsible for compliance could void the user's authority to operate the equipment.

Note: This equipment has been tested and found to comply with the limits for a Class B digital device, pursuant to part 15 of the FCC Rules. These limits are designed to provide reasonable protection against harmful interference in a residential installation. This equipment generates uses and can radiate radio frequency energy and, if not installed and used in accordance with the instructions, may cause harmful interference to radio communications. However, there is no guarantee that interference will not occur in a particular installation. If this equipment does cause harmful interference to radio or television reception, which can be determined by turning the equipment off and on, the user is encouraged to try to correct the interference by one or more of the following measures:

-Reorient or relocate the receiving antenna.

-Increase the separation between the equipment and receiver.

-Connect the equipment into an outlet on a circuit different from that to which the receiver is connected.

-Consult the dealer or an experienced radio/TV technician for help.

The device has been evaluated to meet general RF exposure requirement.

The device can be used in portable exposure condition without restriction.

产品保修

尊敬的用户，本保修卡是申请保修服务的重要凭证，请您配合销售商填写并妥善保管，谢谢！

产品信息	型号	产品条码
用户信息	姓名	联系电话
	通信地址	
销售商信息	名称	
	联系电话	
	通信地址	
	销售日期	
备注		

注：此表应由销售商盖章确认。

产品信息

本文件适用于相关《产品保修信息》(见后面说明)所列产品，其他非属此范围的产品或部件(如促销品、赠品及其他出厂后附加的部件等)不在此保修承诺内。

保修期

产品及部件的相应保修期按相关的《产品保修信息》执行。保修期自产品首次购买日起算，购买日以购买产品时保修卡登记日期为准。

如何获得保修服务

您可直接与产品销售商或授权服务机构联系，也可拨打神牛产品售后服务电话，与我们联系，由我们的服务人员为您安排服务。申请保修时，您应提供有效的保修卡作为保修凭证，方可获得保修。如您不能提供有效的保修卡，则在我们确认产品或部件属于保修范围的情况下，也可以为您提供保修，但这不作为我们的义务。

不适用保修的情况

如产品存在下列情况，本文件项下的保证和服务将不适用：①产品或部件超过相应保修期；②错误或不当使用、维护或保管导致的故障或损坏，如：不当搬运；非按产品合理预期用途使用；不当插拔外接设备；跌落或外力挤压；接触或暴露于不适当温度、溶剂、酸碱、水浸或潮湿环境；③由非神牛授权机构或人员安装、修理、更改、添加或拆卸造成的故障或损坏；④产品或部件原有识别信息被修改变更或除去；⑤无有效保修卡；⑥使用非合法授权、非标准或非公开发行的软件造成的故障或损坏；⑦因不可抗力或意外事件造成的故障或损坏；⑧其他非因产品本身质量问题导致的故障或损坏。遇上述情况，您应向相关责任方寻求解决，神牛对此不承担任何责任。因非在保修期或保修范围内的部件、附件或软件导致产品不能正常使用的，不是保修范围内的故障。产品使用过程中正常的脱色，磨损和消耗，不是保修范围内的故障。

产品保修和服务支持信息

产品的保修期和服务类型按以下《产品保修信息》执行：

产品类别	选件名称	保修期(月)	保修服务类型
部件	主机	12	客户送修
	电池	3	客户送修
	充电器等带电性能的部件。	12	客户送修
其他	如电源线、同步线闪光管、造型灯泡、外壳、保护罩、锁紧装置、包装等。	无	无保修

神牛产品售后服务电话 0755-29609320-8062

Warranty

Dear customers, as this warranty card is an important certificate to apply for our maintenance service, please fill in the following form in coordination with the seller and safe-keep it. Thank you!

Product Information	Model	Product Code Number
Customer Information	Name	Contact Number
	Address	
Seller Information	Name	
	Contact Number	
	Address	
	Date of Sale	
Note		

Note: This form shall be sealed by the seller.

Applicable Products

The document applies to the products listed on the Product Maintenance Information (see below for further information). Other products or accessories (e.g. promotional items, giveaways and additional accessories attached, etc.) are not included in this warranty scope.

Warranty Period

The warranty period of products and accessories is implemented according to the relevant Product Maintenance Information. The warranty period is calculated from the day (purchase date) when the product is bought for the first time. And the purchase date is considered as the date registered on the warranty card when buying the product.

How to Get the Maintenance Service

If maintenance service is needed, you can directly contact the product distributor or authorized service institutions. You can also contact the Godox after-sale service call and we will offer you service. When applying for maintenance service, you should provide valid warranty card. If you cannot provide valid warranty card, we may offer you maintenance service once confirmed that the product or accessory is involved in the maintenance scope, but that shall not be considered as our obligation.

Inapplicable Cases

The guarantee and service offered by this document are not applicable in the following cases:

① **The product or accessory has expired its warranty period;** ② **Breakage or damage caused by inappropriate usage, maintenance or preservation, such as improper packing, improper usage, improper plugging in/out external equipment, falling off or squeezing by external force, contacting or exposing to the improper temperature, solvent, acid, base, flooding and damp environments, etc;** ③ **Breakage or damage caused by non-authorized institution or staff in the process of installation, maintenance, alternation, addition and detachment;** ④ **The original identifying information of product or accessory is modified, alternated, or removed;** ⑤ **No valid warranty card;** ⑥ **Breakage or damage caused by using illegally authorized, nonstandard or non-public released software;** ⑦ **Breakage or damage caused by force majeure or accident;** ⑧ **Breakage or damage that could not be attributed to the product itself.** Once met these situations above, you should seek solutions from the related responsible parties and Godox assumes no responsibility. The damage caused by parts, accessories and software that beyond the warranty period or scope is not included in our maintenance scope. The normal discoloration, abrasion and consumption are not the breakage within the maintenance scope.

Maintenance and Service Support Information

The warranty period and service types of products are implemented according to the following Product Maintenance Information:

Product Type	Name	Maintenance Period(month)	Warranty Service Type
Parts	Circuit Board	12	Customer sends the product to designated site
	Battery	3	Customer sends the product to designated site
	Electrical parts e.g.battery charger, etc.	12	Customer sends the product to designated site
Other Items	Flash tube, power cord, sync cable,modeling lamp,lamp body, lamp cover,locking device, package, etc.	No	Without warranty

Godox After-sale Service Call +86-755-29609320(8062)