



神牛摄影公众号
Follow Wechat Official Account

godox

Vlog套装

Vlog Kit

VK1-UC

VK1-LT

VK1-AX

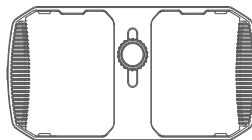
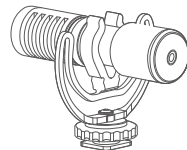

合格证
QC PASS

深圳市神牛摄影器材有限公司

地址: 深圳市宝安区福海街道塘尾社区福川工业区厂房2栋

电话: 0755-29609320(8062) 传真: 0755-25723423 邮箱: godox@godox.com

GODOX Photo Equipment Co., Ltd.

Add: Building 2, Yaochuan Industrial Zone, Tangwei Community, Fuhai Street, Bao'an District, Shenzhen 518103, China

Tel: +86-755-29609320(8062) Fax: +86-755-25723423

E-mail: godox@godox.com

godox.com

Made in China



说明书 | Instruction Manual

前言

感谢您购买神牛产品!

为了满足用户拍摄 Vlog 视频输出稳定、实时补光、现场收音需求。神牛全新开设了 Vlog 套装。套装包含：小巧易携 LED 补光灯 LED6R、轻型枪式麦克风 VD-Mic、迷你三角架 MTO1、手机兔笼 VSS-R01。常用于 Vlog 视频拍摄、户外采访、现场直播、视频会议以及音乐和环境声录制。

LED6R主要特点：

- 多种功能，自由切换 LED 双色温模式、彩光模式和 13 种场景光效模式；
- 自由调节色温、亮度、色彩饱和度；
- 内置锂电池，Type-C USB 接口充电；
- 背部磁性吸附功能，可吸附在铁质物品表面使用；
- 带一个冷靴安装座和三个冷靴槽，可安装在热靴或者冷靴槽里使用，冷靴槽可组合多个灯或者拓展其他器材配件使用；
- 外观时尚，操作简单，轻巧便携。

VD-Mic主要特点：

- 小巧迷你，仅长 80mm，仅重 40g；
- 即插即用，无需额外供电；
- 机身全铝合金打造，拥有更强的抗射频干扰能力；
- 配置专业减震支架及防风兔毛；
- 具备严格的灵敏度管控；
- 超宽的频率响应范围 100-20KHz，更好地收录清晰自然的声音；
- 畅享高品质声学性能；
- 高信噪比同时具备极低的失真度。

警告

- ⚠ LED6R 和 VD-Mic 均没有防水功能，请保持干燥：请勿用湿手接触产品，亦不可将产品浸入水中或暴露于雨中。
- ⚠ 请勿在化学品、可燃性气体或其他特殊物质附近使用 LED6R 和 VD-Mic，有可能导致火灾或电磁干扰。在这些场合下，请注意相关警告标识。
- ⚠ 请勿私自拆卸 Vlog 套装中任何一个产品，如产品出现故障须由本公司或授权的维修人员进行检查维修。
- ⚠ 请勿让儿童接触 Vlog 套装中任何一个产品。
- ⚠ 请勿将 Vlog 套装中任何一个产品放置在超过 50 摄氏度的高温环境中。
- ⚠ 使用供电的注意事项：
请勿给 VD-Mic 幻象供电。VD-Mic 需要插入式供电，一般默认相机的 3.5mm 麦克风输入插口提供即可，大约为 2-3V。连接相机或手机设备即可使用。
- ⚠ LED6R 内置锂电池，禁止拆卸、撞击、挤压或投入火中，若出现严重鼓胀，请勿继续使用。请勿放置在超过 -10°C- 40°C 的环境中。使用产品要求参数的充电器进行充电，并且正确的按照操作说明，在规定的电压、温度范围内使用。
- ⚠ 请仔细阅读并遵守由厂商提供的警告或指示。

部件

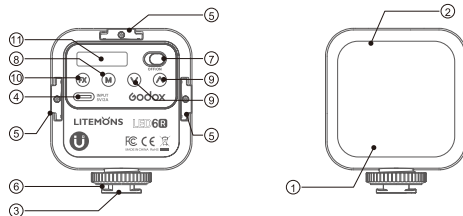

- | | | |
|--------------------|------------|----------|
| 01. 灯珠 | 05. 冷靴槽 | 09. 调节按钮 |
| 02. 柔光片 | 06. 冷靴座 | 10. 光效按钮 |
| 03.1/4 螺孔冷靴安装座 | 07. 开关推钮 | 11. 显示屏 |
| 04.Type-C USB 充电接口 | 08. 模式选择按钮 | |

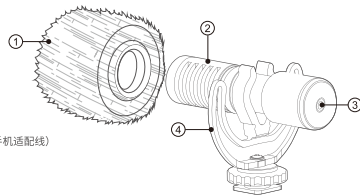

- | | | |
|-----------|---------------------------------|---------------|
| 01 防风毛罩 | 02 麦克风机身 | 03 3.5mm 音频接口 |
| 04 减震支架 | 05 3.5mm TRS-TRRS 音频连接线 (手机适配线) | 06 侧面防护钢网 |
| 07 咪头防护钢网 | 08 防风海绵 | |

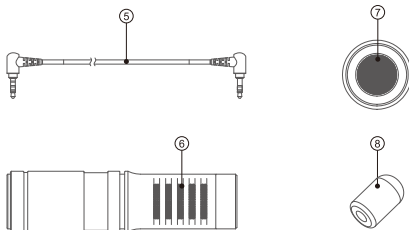

Vlog套装[VK1-UC]标配物品

LED 摄影灯 LED6R*1、Type-C USB 线 *1、柔光罩 *1
轻型指向性枪式麦克风 *1、防风海绵 *1、防风毛罩 *1、TRRS 音频线 *1、3.5mm TRRS 母头转 USB Type-C 转接头线 *1、迷你三脚架 *1、手机兔笼 *1、减震支架 *1



LED 摄影灯
LED6R × 1



Type-C USB 线 × 1



柔光罩 × 1



减震支架 × 1



轻型指向性枪式麦克风 × 1



防风海绵 × 1



防风毛罩 × 1

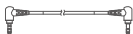

TRRS-TRRS 音频连接线 × 1



3.5mm TRRS母头转
Type-C转接头线 × 1



迷你三脚架 × 1

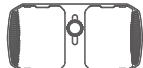

手机兔笼 × 1



说明书 × 1

Vlog套装[VK1-LT]标配物品

LED 摄影灯 LED6R*1、Type-C USB 线 *1、柔光罩 *1
轻型指向性枪式麦克风 *1、防风海绵 *1、防风毛罩 *1、TRRS 音频线 *1、3.5mm TRRS 母头转 Lightning 转接头线 *1、迷你三脚架 *1、手机兔笼 *1、减震支架 *1



LED 摄影灯
LED6R × 1



Type-C USB 线 × 1



柔光罩 × 1



减震支架 × 1



轻型指向性枪式麦克风 × 1



防风海绵 × 1



防风毛罩 × 1

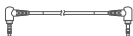

TRRS-TRRS 音频连接线 × 1



3.5mm TRRS母头转
Lightning 转接头线 × 1



迷你三脚架 × 1

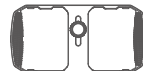

手机兔笼 × 1



说明书 × 1

Vlog套装[VK1-AX]标配物品

LED 摄影灯 LED6R*1、Type-C USB 线 *1、柔光罩 *1
轻型指向性枪式麦克风 *1、防风海绵 *1、防风毛罩 *1、TRRS 音频线 *1、迷你三脚架 *1、手机兔笼 *1、减震支架 *1



LED 摄影灯
LED6R × 1



Type-C USB 线 × 1



柔光罩 × 1



减震支架 × 1



轻型指向性枪式麦克风 × 1



防风海绵 × 1



防风毛罩 × 1

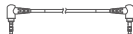

TRRS-TRRS 音频连接线 × 1



迷你三脚架 × 1



手机兔笼 × 1



说明书 × 1

VD-Mic安装说明

一. 安装防护罩、支架与音频线：

1. 将麦克风机身卡入 Rycote Lyre 减震支架上，同时确保麦克风处于中心位置，保持平衡与稳定。
 2. 将所需防风海绵或防风毛罩套入麦克风机身的前端，毛罩与海绵内部均具备容纳麦克风机身的形状，将麦克风机身插进到合适的位置即可。
 3. 连接到手机使用，将 3.5mm TRS-TRRS 音频连接线 3 极端子的一头连接线连接到麦克风接口，音频线的另一头，即 4 极端子连接到手机上即可开始使用。
- Vlog 套装 [VK1-UC] 标配物品具备安卓 type-c 接头转接线，Vlog 套装 [VK1-LT] 标配物品中具备苹果 lightning 接头转接线。

注：音频线插头需完全插入机身接口当中，避免出现不正常工作。

VD-Mic操作技巧

VD-Mic 操作技巧：

为了本产品发挥更好的性能，使用时请注意不要使用其他非官方配件，如防风毛罩，防风海绵。若使用其他厂商的音频线可能导致麦克风不能正常工作严重时可能损坏。
避免手或其他物品遮挡住任何进音孔，否则可能影响麦克风的性能。

LED6R操作说明

1. 灯设置

1.1. 开关机

开关按钮推至 ON, 灯打开, 屏幕显示主机当前灯光参数信息, 推至 OFF 灯关闭。



1.2. 模式选择: 双色温模式 / 彩光模式 / 情景光效模式

长按 M 按钮切换模式:

显示屏上显示为 CCT 即双色温模式。



显示 HSI 即为彩光模式。



按 FX 按钮进入情景光效模式, 显示 13 种光效序号和图标。



2. 双色温模式: 长按M按钮选择

2.1 短按 M 按钮选择要调整的数值, 选中反色显示。



2.2 色温调节: 上调节按钮 增加色温值, 下调节按钮 降低色温值, 短按一次数值变动 100K, 长按快速调节, 调节范围 3200K ~ 6500K。

2.3 亮度调节: 上调节按钮 增加亮度值, 下调节按钮 降低亮度值, 短按一次数值变动 1%, 长按快速调节, 调节范围 0 ~ 100%。

3. 彩光模式: 长按M按钮选择

3.1 短按 M 按钮选择要调整的数值, 选中反色显示。



3.2 调节色相 H: 上调节按钮 增加色相值, 下调节按钮 降低色相值, 短按一次数值变动 1°, 长按快速调节, 色相调节范围 0 ~ 360°。

3.3 调节饱和度 S: 上调节按钮 增加饱和和度值, 下调节按钮 降低饱和和度值, 短按一次数值变动 1, 饱和和度调节范围 0-100。

3.4 亮度调节 I: 上调节按钮 增加亮度值, 下调节按钮 降低亮度值, 短按一次数值变动 1%, 长按快速调节, 调节范围 0 ~ 100%。

4. 情景光效模式

4.1 按 Fx 按钮进入情景光效模式, 短按 Fx 按钮 13 种光效循环切换, 长按快速循环;

4.2 情景光效模式 13 种: 可根据需求选择。



序号	显示	情景光效
1		彩光循环
2		闪光灯
3		激光彩灯
4		雷闪电
5		坏灯泡
6		电视机
7		蜡烛
8		火
9		烟花
10		警车
11		消防车
12		救护车
13		SOS

产品参数

型号	LED6R
内置锂电池	1800mAh
充电电源	5V/2A
功率	最大6W
色温范围	3200K~6500K
100%光照度(LUX)(0.5米)(≈)	270
CRI(≈)	95
调光范围	0%~100%
持续使用时间	2H-10H
工作环境温度	-10~40°C
产品尺寸	77*66*30 mm
净重	110g

型号	VD-Mic
信噪比	75dB
灵敏度	-33dB±2(0dB=1V/Pa at 1KHz)
音频频率范围	100-20KHz
拾音模式	心型指向
最大声压级	120dB(THD≤3% at 1KHz)
等效噪声级(A计权)	20dB
音频连接线插头	3.5mm接口
重量	40g
产品尺寸	长80mm Φ21mm
工作温度	-10~+50°C

注：手机兔笼可夹手机宽度：60-90mm

VD-Mic维护保养

避免跌落：如果受到强烈碰撞或振动，设备可能会发生故障。

保持干燥：本产品是非防水产品，如果将其浸入水中或放置于高温度的环境中将可能发生故障。

内部构造生锈可能会导致无法修理的损害。

避免温度骤变：温度的突变，诸如在寒冷天进出温暖的大楼将可能会使产品内部结露。为避免结露，请将本产品事先装入手提袋或塑料包内，以防温度突变。

远离强磁场：无线电广播发射机等设备产生的强静电或强磁场可能会干扰本产品正常工作。

LED6R维护保养

灯体在工作时，如发现异常，应立即关掉电源，查明原因。灯体应避免震动，平时注意表面除尘。

灯体稍发热为正常现象。维修概由本厂指定可供原厂配件之维修部负责。

本产品保修一年，消耗品不在一年保修范围内，内置电池保修六个月。

经发现，擅自检修此灯的，将取消灯一年保修期，维修需要收取相关费用。

如果本品出现故障或者被水淋湿，在专业人员维修后方可继续使用。

Declaration of Conformity

GODOX Photo Equipment Co.,Ltd. hereby declares that this equipment are in compliance with the essential requirements and other relevant provisions of Directive 2014/30/EU. They are allowed to be used in all EU member states.

For more information of DoC, Please click this web link:

http://www.godox.com/DOC/Godox_LED6R_DOC.pdf

https://www.godox.com/DOC/Godox_VD-Mic_DOC.pdf

Forward

Thank you for purchasing!

To fully meet the needs of users for stable Vlog video output, real-time fill light, and live radio, we, Godox, provide a new series of Vlog Kit. This kit includes: the RGB LED Video Light LED6R, the Compact Directional Shotgun Microphone VD-Mic, the Mini Tripod MT01, and the Smartphone Rig VSS-R01, which will benefit Vlog video shooting, outdoor interviews, live broadcasts, video conferences, music and ambient sound recording etc.

LED6R Main Features

- Switch freely between LED CCT mode, RGB recycle mode and 13 kinds of FX light effects mode
- Easy to adjust color temperature, brightness and color saturation
- With built-in lithium battery and it can be charged through Type-C USB port
- With magnetic absorbed function it can be absorbed onto the iron surface
- Can be used independently or in combination with cold shoe mounting base and slots
- Fashionable in appearance, intuitive in operation, and portable in carrying

V-Mic Product Features

- With 80mm's length and weighs 40g
- Inserted into equipment to use directly without extra power supply
- Aluminum alloy materials with stronger RFI resistance
- With professional shock-absorbing bracket and furry windscren
- Strict sensitivity control
- 100-20KHz Broad frequency response range to offer better voice recording and reproduce
- High-quality voice performance
- High signal noise ratio and low distortion degree

Warning

- ⚠ Both LED6R and VD-Mic are not waterproof devices. Please take measures of waterproof in rainy or damp environment.
- ⚠ Please don't use this kit in flammable and combustible environments. In certain circumstance, please pay attention to the relevant warnings.
- ⚠ Do not disassemble. Should repairs become necessary, this kit must be sent to an authorized maintenance center.
- ⚠ Keep this kit out of reach of children.
- ⚠ Do not leave or store this kit if the ambient temperature reads over 50°C.
- ⚠ Observe precautions in power supply:
 - Do not supply VD-Mic with phantom power. As VD-Mic needs plug-in power supply, it is recommended to supply power by 3.5mm microphone input port of camera, which is about 2 to 3V. Connect the microphone to the camera or smartphone to use.
 - As LED6R has built-in lithium battery, do not disassemble, impact, squeeze or put it into fire. If serious bulge occurs, please do not use. Do not use or store the product

if the ambient temperature reads over the range of -10°C to 40°C . Please charge the product with included adapter and correctly operate it within the defined voltage and working temperate according to the instruction manual.

⚠ Please carefully read and observe the warning or direction offered by the manufacture.

Structure of Product

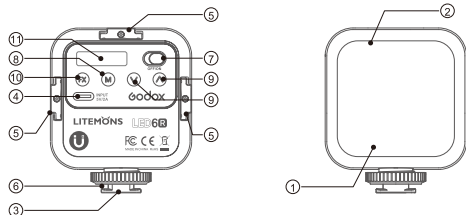

- | | | |
|----------------------------------|---------------------------|--------------------------|
| 01. LED Beads | 05. Cold Shoe Slot | 08. Adjustment Button |
| 02. Diffusion | 06. Cold Shoe Base | 10. Light Effects Button |
| 03. 1/4" Cold Shoe Mounting Base | 07. Power Switch | 11. Display |
| 04. Type-C USB Charging Port | 08. Mode Selection Button | |

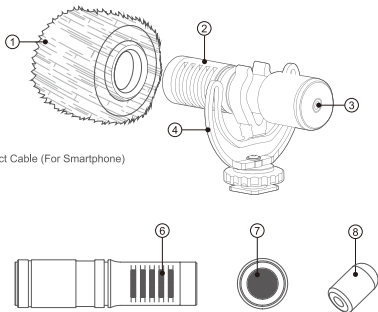

- | |
|---------------------------------------------------------|
| 01. Wind Cap |
| 02. Microphone Body |
| 03. 3.5mm Audio Port |
| 04. Shock-absorbing Bracket |
| 05. 3.5mm TRS-TRRS Audio Connect Cable (For Smartphone) |
| 06. Protective Steel Mesh |
| 07. MIC Steel Mesh |
| 08. Windscreen Foam |

What's in the Box [VK1-UC]

LED6R*1, Type-C USB Cable*1, Diffuser*1, Microphone*1, Windscreen Foam*1, Wind Cap*1, TRRS Audio Connect Cable*1, 3.5mm TRRS Female to USB Type-C Adapter Cable*1, Mini Tripod*1, Smartphone Rig*1, Shock-absorbing Bracket*1

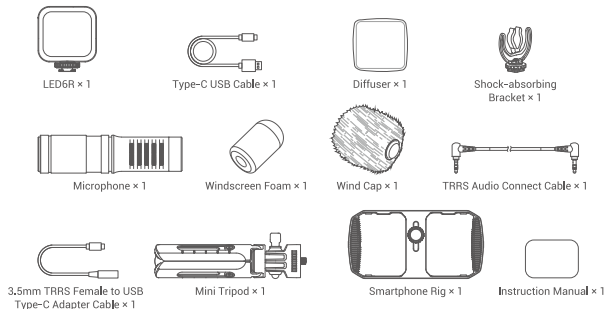

What's in the Box [VK1-LT]

LED6R*1, Type-C USB Cable*1, Diffuser*1, Microphone*1, Windscreen Foam*1, Wind Cap*1, TRRS Audio Connect Cable*1, 3.5mm TRRS Female to Lightning Adapter Cable*1, Mini Tripod*1, Smartphone Rig*1, Shock-absorbing Bracket*1

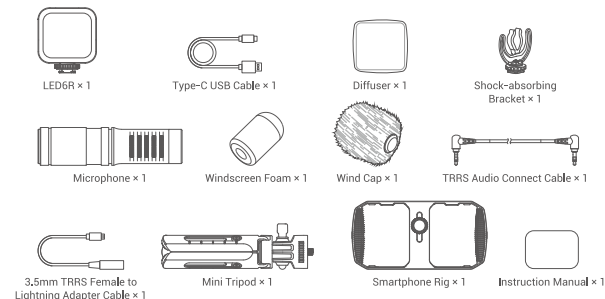

What's in the Box [VK1-AX]

LED6R*1, Type-C USB Cable*1, Diffuser*1, Microphone*1, Windscreen Foam*1, Wind Cap*1, TRRS Audio Connect Cable*1, Mini Tripod*1, Smartphone Rig*1, Shock-absorbing Bracket*1



LED6R × 1



Type-C USB Cable × 1



Diffuser × 1



Shock-absorbing Bracket × 1



Microphone × 1



Windscreen Foam × 1



Wind Cap × 1

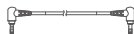

TRRS Audio Connect Cable × 1



Mini Tripod × 1

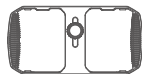

Smartphone Rig × 1



Instruction Manual × 1

VD-Mic Usage Instruction

Install Protective Cover, Bracket and Audio Cable

1. Insert the microphone into the Rycote Lyre shock-absorbing bracket and make sure that the microphone is placed in the center and keep balance.
2. Install the windscreen foam or cap onto the former end of the microphone to the suitable place.
3. To connect to the smartphone, please choose the 3.5mm TRS-TRRS Audio Connect Cable and insert one end of the triple terminals into the microphone port. The other end of the audio cable, namely, the quadrupole terminal, shall be connected to the smartphone.
4. Vlog Kit [VK1-UC] equipped with the Android Type-C Connect cable, while, Vlog Kit [VK1-LT] equipped with the Apple Lightning Connect Cable.

Note: Note: the audio plug shall be fully inserted into the port to avoid abnormal working.

VD-Mic Operation Method

To exert the optimum function of this product, please do not use non-official included accessories e.g. windscreen foam or wind cap, etc. The microphone may do not work properly or be seriously damaged if using other manufacturer's audio cables.

Do not block or shield any sound hole, otherwise, the microphone's performance may be influenced.

LED6R Usage Instruction

1. Light Setting

1.1 Power ON/OFF

Please push the power switch onto ON to power on the light and the current parameters will be displayed. Push the power switch to OFF to power the light off.



1.2 Mode Selection: CCT Mode/Colorful Mode/Light Effects Mode

Long press the M button to switch different modes: displayed CCT means bi-color mode and HSI means colorful mode.

Press FX button to enter light effects mode. And the 13 categories modes and icons will be displayed.



2. CCT Mode

long press the M button to choose this mode.

2.1 Short press the M button to choose the value to be adjusted.



2.2 Color temperature adjustment: press the upper adjustment button to increase the color temperature value while lower button to decrease. Short press the button once and the color temperature value will changes in 100K. Long press the button to adjust the value from 3200K to 6500K quickly.

2.3 Brightness adjustment: press the upper adjustment button to increase the brightness value while lower button to decrease. Short press the button once and the color temperature value will changes in 1%. Long press the button to adjust the value from 0 to 100% quickly.

3. Colorful Mode

3.1 Short press the M button to choose the value to be adjusted.

3.2 H hue adjustment: press the upper adjustment button to increase the hue value while lower button to decrease. Short press the button once and the hue value will changes in 1°. Long press the button to adjust the value from 0 to 360° quickly.

3.3 S Saturation adjustment: press the upper adjustment button to increase the saturation value while lower button to decrease. Short press the button once and the saturation value will changes in 1. Long press the button to adjust the value from 0 to 100 quickly.

3.4 Brightness adjustment: press the upper adjustment button to increase the brightness value while lower button to decrease. Short press the button once and the brightness value will changes in 1%. Long press the button to adjust the value from 0 to 100% quickly.



4. FX Light Effects Mode

4.1 Press the FX button to enter light effects modes. Then, short press the FX button to switch the 13 effects in recycle while long pressing to change them quickly.

4.2 There are 13 categories to be selected according to your demands.



No.	Display	Light Effects
1		RGB Recycle
2		Flash
3		Laser
4		Lightning
5		Broken Bulb
6		TV
7		Candle
8		Fire
9		Firework
10		Police Car
11		Fire Truck
12		Ambulance
13		SOS

Technique Data

Model	LED6R
Built-in Lithium Battery	1800mAh
Power Source of Charging	5V/2A
Power	Max. 6W
Color Temperature Range	3200K ~ 6500K
100% Illuminance(LUX)(0.5m)(=)	270
CRI(=)	95
Brightness Range	0%~100%
Duration	2H-10H
Working Environment Temperature	-10~40°C
Dimension	77*66*30 mm
Net Weight	110g

Model	VD-Mic
Signal-noise ratio	75dB
Sensitivity	-33dB±2 (0dB=1V/Pa at 1KHz)
Audio frequency range	100-20KHz
Pick-up sound mode	Cardioid directivity
Max. sound pressure level	120dB (THD≤3% at 1KHz)
Equivalent noise level (A-weighting)	20dB
Audio cable plug	3.5mm port
Weight	40g
Dimension	80mm Φ21mm
Working temperature	-10°C to +50°C

Note: Smartphone Rig for phone width of 60-90mm.

VD-Mic Maintenance

- Avoid sudden drops. The device may fail to work after strong shocks, impacts, or excess stress.
- Keep dry.
- The product isn't water-proof. Malfunction, rust, and corrosion may occur and go beyond repair if soaked in water or exposed to high humidity.
- Avoid sudden temperature changes. Condensation happens if sudden temperature changes such as the circumstance when taking the product out of a building with higher temperature to outside in winter. Please put the product in a handbag or plastic bag beforehand.
- Keep away from strong magnetic field. The strong static or magnetic field produced by devices such as radio transmitters leads to malfunction.
- Changes made to the specifications or designs may not be reflected in this manual.

LED6R Maintenance

- Shut down the device immediately should abnormal operation be detected.
- Avoid sudden impacts and the product should be dedusted regularly.
- It is normal for the light beads to be warm when in use.
- Maintenance of the light must be performed by our authorized maintenance department which can provide original accessories.
- This product, except consumables, is supported with a one-year warranty. Lithium battery is supported with six months warranty.
- Unauthorized service will void the warranty.
- If the product had failures or was wetted, do not use it until it is repaired by professionals.
- Changes made to the specifications or designs may not be reflected in this manual.

产品保修

尊敬的用户,本保修卡是申请保修服务的重要凭证,请您配合销售商填写并妥善保管,谢谢!

产品信息	型号	产品条码
用户信息	姓名	联系电话
	通信地址	
销售商信息	名称	
	联系电话	
	通信地址	
	销售日期	
备注		

注:此表应由销售商盖章确认。

产品保修和服务支持信息

产品的保修期和服务类型按以下《产品保修信息》执行:

产品类别	选件名称	保修期(月)	保修服务类型
部件	主机	12	客户送修
	电池	3	客户送修
	充电器、电源线,同步线等带电性能的部件	12	客户送修
其他	如电池盒、防风棉、防风毛罩、锁紧装置、手提绳、扎带、魔术贴、领夹、便携袋、包装等	无	无保修

神牛产品售后服务电话 0755-29609320-8062

产品信息

本文件适用于相关《产品保修信息》(后面说明)所列产品,其他非属此范围的产品或部件(如赠品、赠品及其他出厂后附加的部件等)不在此保修承诺内。

保修期

产品及部件的相应保修期按相关的《产品保修信息》执行。保修期自产品首次购买日起算,购买日以购买产品时保修卡登记日期为准。

如何获得保修服务

要保修服务,您可直接与产品销售商或授权服务机构联系,也可拨打神牛产品售后服务电话,与我们联系,由我们的服务人员为您安排服务。申请保修时,您应提供有效的保修卡作为保修凭证,方可获得保修。如您不能提供有效的保修卡,则在我们可确认产品或部件属于保修范围的情况下,也可以为您提供保修,但这不作为我们的义务。

不适用保修的情况

如产品存在下列情况,本文件项下的保证和服务将不适用 ① 产品或部件超过相应保修期;② 错误或不适当使用、维护或保管导致的故障或损坏,如:不当搬运;非按产品合理预期用途使用;不当插拔外接设备;跌落或外力挤压;接触或暴露于不适当温度、溶剂、酸碱、水浸或潮湿环境;③ 由非神牛授权机构或人员安装、修理、更改、添加或拆卸造成的故障或损坏;④ 产品或部件原有识别信息被修改变更或删除;⑤ 无有效保修卡;⑥ 使用非法授权、非标准或非公开发行的软件造成的故障或损坏;⑦ 因不可抗力或意外事件造成的故障或损坏;⑧ 其他非因产品本身质量问题导致的故障或损坏。遇上述情况,您应向相关责任方寻求解决,神牛对此不承担任何责任。因非在保修期或保修范围内的部件、附件或软件导致产品不能正常使用的,不是保修范围内的故障。产品使用过程中正常的脱色、磨损和消耗,不是保修范围内的故障。

Warranty

Dear customers, as this warranty card is an important certificate to apply for our maintenance service, please fill in the following form in coordination with the seller and safe-keep it. Thank you!

Product Information	Model	Product Code Number
Customer Information	Name	Contact Number
	Address	
Seller Information	Name	
	Contact Number	
	Address	
	Date of Sale	
Note		

Note: This form shall be sealed by the seller.

Applicable Products

The document applies to the products listed on the Product Maintenance Information (see below for further information). Other products or accessories (e.g. promotional items, giveaways and additional accessories attached, etc.) are not included in this warranty scope.

Warranty Period

The warranty period of products and accessories is implemented according to the relevant Product Maintenance Information. The warranty period is calculated from the day (purchase date) when the product is bought for the first time. And the purchase date is considered as the date registered on the warranty card when buying the product.

How to Get the Maintenance Service

If maintenance service is needed, you can directly contact the product distributor or authorized service institutions. You can also contact the Godox after-sale service call and we will offer you service. When applying for maintenance service, you should provide valid warranty card. If you cannot provide valid warranty card, we may offer you maintenance service once confirmed that the product or accessory is involved in the maintenance scope, but that shall not be considered as our obligation.

Inapplicable Cases

The guarantee and service offered by this document are not applicable in the following cases:

①. The product or accessory has expired its warranty period; ②. Breakage or damage caused by inappropriate usage, maintenance or preservation, such as improper

packing, improper usage, improper plugging in/out external equipment, falling off or squeezing by external force, contacting or exposing to the improper temperature, solvent, acid, base, flooding and damp environments, etc; ③. Breakage or damage caused by non-authorized institution or staff in the process of installation, maintenance, alternation, addition and detachment; ④. The original identifying information of product or accessory is modified, alternated, or removed; ⑤. No valid warranty card; ⑥. Breakage or damage caused by using illegally authorized, nonstandard or non-public released software; ⑦. Breakage or damage caused by force majeure or accident; ⑧. Breakage or damage that could not be attributed to the product itself. Once met these situations above, you should seek solutions from the related responsible parties and Godox assumes no responsibility. The damage caused by parts, accessories and software that beyond the warranty period or scope is not included in our maintenance scope. The normal discoloration, abrasion and consumption are not the breakage within the maintenance scope.

Maintenance and Service Support Information

The warranty period and service types of products are implemented according to the following Product Maintenance Information:

Product Type	Name	Maintenance Period(month)	Warranty Service Type
Parts	Product Main Body	12	Customer sends the product to designated site
	Battery	3	Customer sends the product to designated site
	Charger, Power Cable, Sync Cable, Electrical Parts etc.	12	Customer sends the product to designated site
Other Items	Battery Case, Windscreen Foam, Wind Cap, Locking Device, Lanyard, Tie, Velcro Tape, Clip, Bag, Package etc.	No	Without warranty

Godox After-sale Service Call 0755-29609320-8062