

# Installation Instructions For Topmount Sink

## CARE AND MAINTENANCE

Regularly clean the sink with warm soapy water then dry with a soft cloth after each use. Household detergents suitable for stainless steel may also be used.

Avoid harsh chemicals and abrasive cleaners. Do not use steel wool or other abrasive pads to clean your sink.

Do not use chemical silver cleaners, bleaches, or detergents containing chlorine or any of its derivatives.

Acidic or corrosive materials and foods such as tea, coffee, juices, salt, vinegar, mustard etc. should be rinsed off immediately with plenty of water.

Do not place hot objects directly onto the sink. Appropriate potholders or boards should be used. Be mindful of handling heavy or sharp objects near the sink surface.

1. Place the insert template onto bench top in the desired location. Trace around the border of the template.

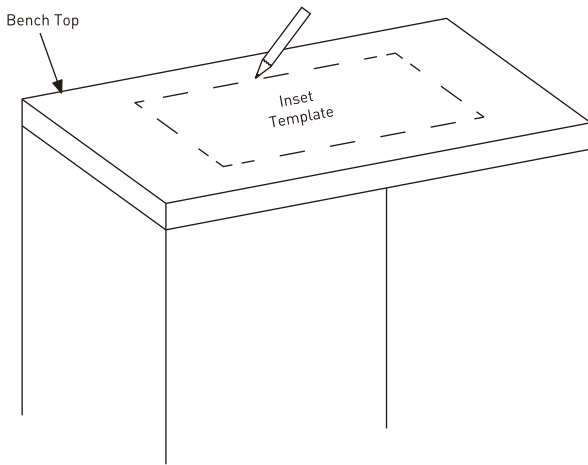

**NOTE:** Templates are provided as a guide only. Before cutting, double check that the measurements of your traced line is accurate to your bowl dimensions.

2. Use the appropriate cutting tool suitable for your bench top material, cut along the line.
3. Apply a bead of wet area (neutral cure) silicone sealant around the underside edge of the sink.

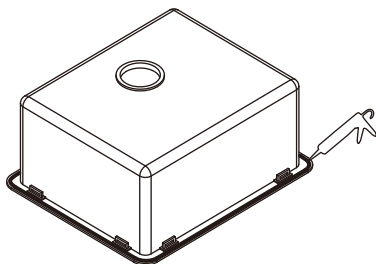

4. Push the mounting brackets onto the sink. Carefully place the sink into the cut out. Push down on all edges of the sink to ensure a good seal is achieved.

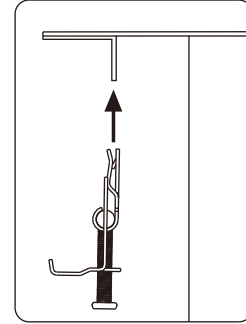

5. The mounting brackets are suitable for bench tops 30-40mm thick. For thinner bench tops, use wooden wedges between the mounting brackets and the bench top.

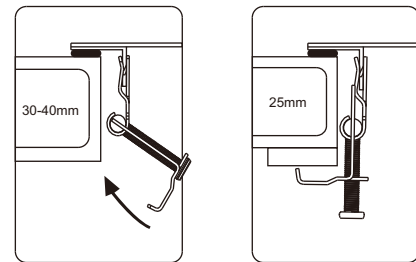

6. Using a screwdriver, tighten the mounting brackets to secure the sink to the bench top. Do not over-tighten. Wipe away excess sealant. connect drain and water supply accordingly.

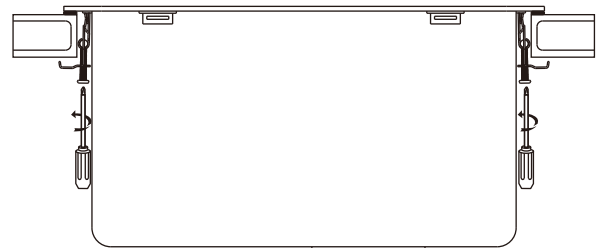

**NOTE:** The one year comprehensive labour warranty cover for the undermount sink will be void if the sink is improperly installed, such as installing the sink in a way that it can't be removed by unscrewing it from the mounting clips, as well as in the case that adhesive is used to permanently attach the sink to the countertop. The sink must be installed using the installation clips provided. The installation instructions provided below must be followed carefully to ensure the correct installation. Installation must only be conducted by a certified or professional trades person.

The sink must be thoroughly inspected before installation. By installing the sink, the owner accepts that the product is free from damages.

Counter top material may vary and the correct type of fasteners should be recommended by your installer.

Cut out the appropriate template for your sink model and desired installation option.

This template is intended as a guide only. The actual sink should be used to ensure accurate cut-out measurements.

Trace the outline of the undermount line template and cut countertop according to templated outline using appropriate cutting tools.

Locate the drill holes on the underside of the countertop, approximately 25.4mm from edge of the sink to be installed. Holes should be evenly spaced approximately 150mm to 200mm apart starting from every corner as shown in.

We recommended installing the mixer/taps at this point to understand the desired positioning before completing the sink installation.

Loosely attach mounting brackets to the countertop, parallel to the cutout opening using the supplied mounting screws and nuts.

Clean sink flange and underside of cutout area of countertop, making sure that the area is smooth and free of grease. Apply continuous bead of silicone caulk evenly on top of sink flange.

Position and align sink over opening. Press sink onto silicone seal.

After rechecking alignment, tighten clip brackets.

Check alignment of sink again and tighten fasteners to secure sink.

Wipe away excess silicone caulk with a cloth. Connect drain and water supply according to regulation requirements.

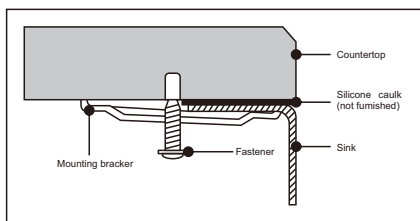

FIGURE 1

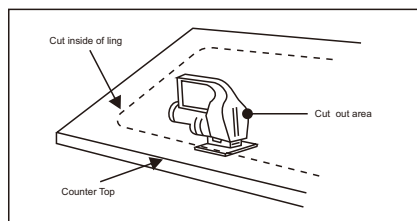

FIGURE 2

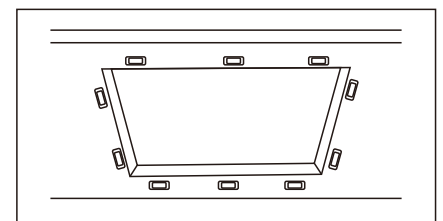

FIGURE 3

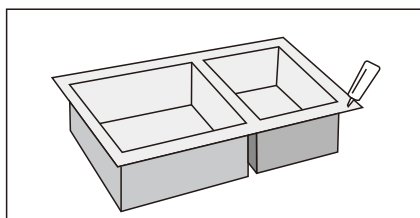

FIGURE 4

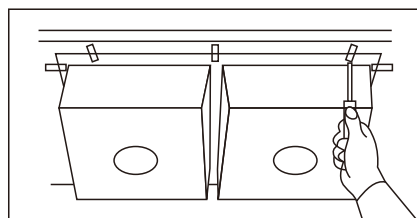

FIGURE 5

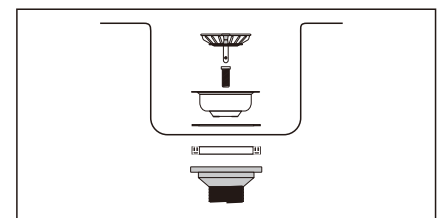

FIGURE 6