



## OWNER'S MANUAL



GXT67 PRO

MIDLANDUSA.COM

Thank you for choosing the GXT67 PRO radio from Midland. Please read through this manual thoroughly to ensure you get peak performance from your radio. You can also find additional information about the GXT67 PRO on our website at [midlandusa.com](http://midlandusa.com) or may contact our Customer Service team at [support@midlandusa.com](mailto:support@midlandusa.com).

## Features

- Up to 99 GMRS Channels
  - 22 Standard GMRS Channels
  - 28 Preset Privacy Code Channels
  - Up to 49 User-Defined Channels
- 8 Standard GMRS Repeater Channels
- 142 Privacy Codes and Group Mode
  - 38 CTCSS Privacy Codes, 104 DCS Privacy Codes
  - 10 Groups, 143 Group Codes
- NOAA Weather Radio
- NOAA Weather Scan and Alert Technology
- IP67 waterproof and dustproof
- VOX hands free
- Group and direct call
- 10 selectable call alert tones
- Vibrate alert and whisper talk
- Active Noise Cancellation (ANC) during transmission
- SOS siren
- High / Medium / Low TX Power Settings
- Selected channel scan and Dual Watch Pro
- Backlight off or 5 brightness levels plus, 7 backlight colors
- Battery Level Meter with Low Battery Indicator
- Narrow and wide band operation
- Silent operation, keypad lock, monitor and roger beep
- Accessory jack

This device complies with Part 15 of the FCC Rules. Operation is subject to the following two conditions: (1) this device does not cause harmful interference, and (2) this radio must accept any interference that may cause undesired operation. To maintain compliance with FCC's RF exposure guidelines, for body-worn operation, this radio has been tested and meets the FCC RF exposure guidelines when used with Midland Radio Corp. accessories supplied or designated for this product. Use of other accessories may not ensure compliance with FCC RF exposure guidelines.

**IMPORTANT NOTICE. FCC LICENSE REQUIRED FOR GMRS OPERATION  
(Only Applicable for GMRS Radio Use in the United States)**

The radios operate on General Mobile Radio Service (GMRS) frequencies which require a Federal Communications Commission (FCC) license. You must be licensed prior to operating the radio. Serious penalties could result from unlicensed use of GMRS channels, in violation of FCC rules, as stipulated in the Communications Acts Sections 501 and 502 (amended).

You will be issued a call sign by the FCC which should be used for station identification when operating the radio on GMRS channels. You should also cooperate by engaging in permissible transmissions only, avoiding channel interference with other GMRS users, and being prudent with the length of your transmission time.

Apply for a license at the FCC's website:

<http://www.fcc.gov/wireless/universal-license-system>

Contact the FCC at 1-888-225-5322 if you have any questions.

**IMPORTANT NOTICE, Exposure to Radio Frequency Energy**

This radio complies with IEEE and ICNIRP radio frequency (RF) energy exposure limits for General Population / Uncontrolled Environments. In order to experience RF energy exposure below these limits, transmit no more than 50% of the time and maintain a distance of at least 2.5 cm between the face and the radio while transmitting. Compliance of this radio with RF exposure limits when body-worn is verified only with the approved, original accessories (Belt Clip and headset). Do not use this device if the antenna is damaged.

This product is compliant with FCC RF Exposure requirements. Refer to the FCC website <https://apps.fcc.gov/oetcf/eas/reports/GenericSearch.cfm> and search for FCC ID: MMAGXT67 to find more information, including SAR values.

**IMPORTANT:** Changes or modifications to this unit not expressly approved by **MIDLAND RADIO CORP.** could void your right to operate this unit. Your radio is set up to transmit a regulated signal on an assigned frequency. It is against the law to alter or adjust the settings inside the DEVICE to exceed those limitations. Any adjustment to your radio must be made by qualified technicians.

## LCD DISPLAY

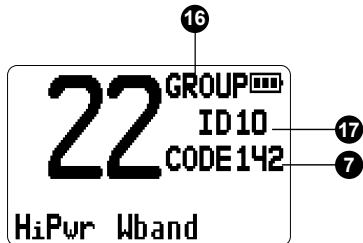
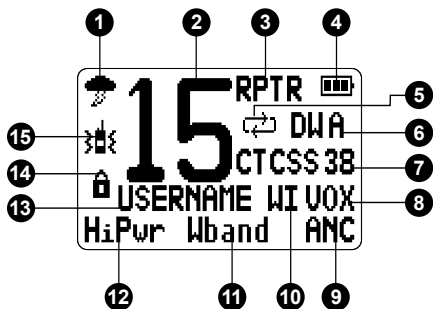

- NOAA Weather (WX) ICON** – Indicates when the radio is in weather band mode and alert readiness status.
- CHANNEL NUMBER** – Indicates GMRS or repeater channel number (1-99). In weather modes, indicates NOAA WX channel number (1-10).
- REPEATER ICON** – Indicates when the current channel is a repeater channel.
- BATTERY METER** – Indicates battery level and battery-low status.
- SCAN ICON** – Indicates when GMRS, Dual Watch Pro, or weather channel scanning modes are active.
- DUAL WATCH ICON** – Indicates primary or active channel during Dual Watch Pro scanning.
- PRIVACY ICON AND CODE** – Indicates privacy code type and number when CTCSS (1-38) or DCS (1-104) is used on the channel. Also shows CODE and the number (0-142) to indicate group code.
- VOX ICON** – Indicates when VOX mode is active.
- NOISE CANCELLATION ICON** – Indicates when active noise cancellation will be active during transmissions.
- WHISPER ICON** – Indicates when whisper microphone amplification will be active.
- BAND ICON** – Indicates whether the radio is operating with wide band (W) or narrow band (N) modulation.
- TRANSMIT (TX) POWER LEVEL ICON** – Indicates TX Power setting high, medium, or low (Hi / Med / Low).
- USERNAME** – Indicates user-defined name for the current channel (configurable only through the PC interface).
- KEY LOCK ICON** – Indicates functions of some buttons are disabled.
- VIBRATE ALERT ICON** – Indicates when the vibrate call alerting is active.
- GROUP ICON** – Indicates group mode is active.
- GROUP ID AND NUMBER** – Indicates the radio's group ID number (1-10) when operating in group mode.

## CONTROLS



1. **POWER / VOLUME KNOB** – Turn clockwise to turn the power on and increase the volume level. Turn counterclockwise to decrease the volume level and turn the power off
2. **ANTENNA**
3. **SPEAKER** – Built-in speaker
4. **PTT BUTTON** – Press and hold to transmit voice communications. Within menus, acts as a “back” button to accept settings (if changed) and return to the prior menu level.
5. **EXTERNAL SPEAKER / MIC** – Accessory jack protected with a waterproof and dustproof cover.
6. **MIC** – Built-in microphone
7. **DOT – MATRIX LIQUID CRYSTAL DISPLAY (LCD)**
8. **DOWN / SOS SIREN BUTTON** – Use to scroll through menu options. Press and hold for 3 seconds to activate the SOS siren.
9. **MENU / WX BUTTON** – Press to access and advance “forward” in menus. Press and hold for 3 seconds to enter NOAA Weather Radio modes and selections.
10. **UP BUTTON** – Use to scroll through Menu options.
11. **CALL / LOCK BUTTON** – Press to send a CALL Alert signal. Press and hold to turn KEY LOCK on / off.
12. **SCAN / MONITOR BUTTON** – Press to enter or exit SCAN mode. Press and hold to enter or exit MONITOR mode.
13. **TX / RX LED** – Indicates the radio is actively receiving (green) or actively transmitting (red).
14. **LANYARD / TETHER LOOP** – Loop for attaching a lanyard or tether.

## OPTIONAL COMPUTER (PC) INTERFACE

In addition to providing a convenient interface for viewing and changing a radio's configuration, the PC interface provides the following capabilities that are not available using the radio menu interface:

1. Save and (re)load configurations
2. Define up to 49 custom channels (51 – 99)
3. Assign a custom name to a channel (containing up to 8 letters or numbers)

To use the optional PC interface, obtain the interface cable and download the PC application through the Midland GXT67 PRO product page at [midlandusa.com](http://midlandusa.com)

## INSTALLING THE BELT CLIP

1. Slide the clip post down into the belt clip latch on the back of the radio until the lock tab clicks.
2. Insert the clip post into the belt clip **upside down** until the belt clip's locking tab clicks.
3. Rotate the belt clip 180 degrees until the radio and clip both face upward and are securely in place.

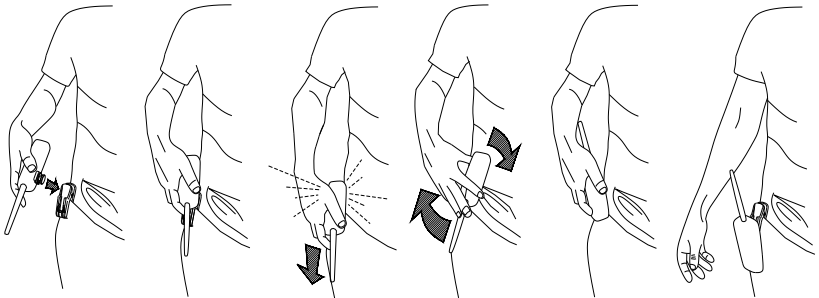
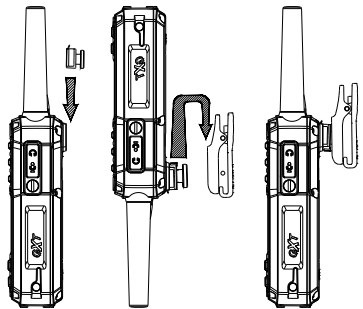

## REMOVING THE BELT CLIP

To remove, rotate the radio 180 degrees until radio is upside down. Gently move the radio up toward the top of the belt clip until it slides out.

To remove the clip post, gently pull the lock tab away from the radio, then gently move the clip post towards the top of the radio.

## INSTALLING EXTERNAL ACCESSORIES

1. Remove the accessory jack cover and set it aside for safekeeping while using accessories.
2. Insert the accessory plug into the speaker/mic jack, making sure it is securely in place and has made a good connection.
3. Reinstall and tighten the accessory cover when finished using accessories.



Proper tightening of the accessory jack cover is necessary for maintaining the IP67 waterproof and dustproof performance of the radio.

## CHARGING THE BATTERY PACK

Your GXT67 PRO radio comes with a rechargeable internal battery that can be charged using the desktop charger or the vehicle power adapter. The desktop charger and USB-C cable are compatible with industry-standard power delivery (PD) and quick-charging USB-C AC wall adapters.

The battery may be charged while the radio is either on or off, but charging will take more time with the radio on.

### Using the Desktop Charger

1. Connect one USB-C cable connector to a compatible AC wall adapter.
2. Connect the other USB-C cable connector to the desktop charger.
3. Plug the AC wall adapter into an AC power outlet.

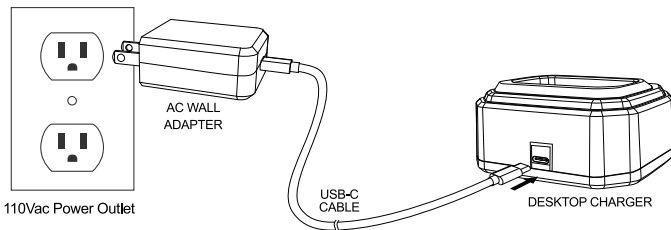

4. Insert the radio into the desktop charger. The LCD backlight will turn red to indicate the radio is properly placed and charging.
5. Remove the radio from the charger when the LCD backlight turns green, indicating it is fully charged.

## Using the Vehicle Power Adapter

1. Plug the DC adapter into a DC vehicle power outlet. Make sure power is supplied to the outlet.
2. The LCD backlight will provide a red indication while the radio is properly placed in the adapter, vehicle power is applied, and the battery is charging.
3. The LCD backlight will provide a green indication while the radio is properly placed in the adapter, vehicle power is applied, and the battery is full.

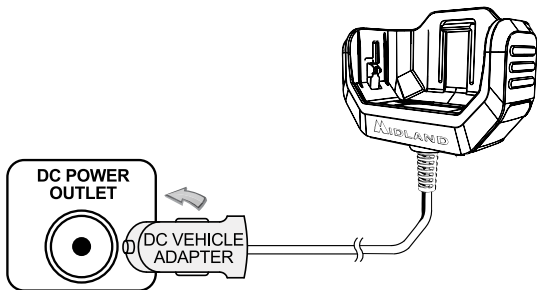

## BATTERY LEVEL INDICATOR

Your GXT67 PRO has a **battery level meter**  that shows the estimated remaining battery capacity (3 bars > 75%, 2 bars 50% to 74%, 1 bar 25% to 49%, shell only < 25%).

When the battery level is low, the **battery shell**  icon will flash in the display indicating your battery needs to be recharged.



## ABOUT RANGE

Your GXT67 PRO radio is designed to give you a maximum range under optimal conditions.

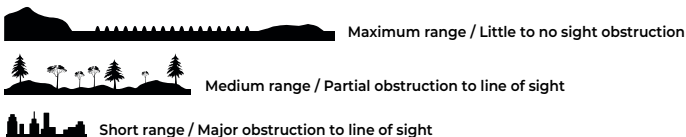

Optimal Conditions are:

- Over water
- Open rural areas without obstructions
- Flat areas where you can see the other person

To ensure you get maximum range:

- Be sure to fully charge the GXT67 PRO's battery – a low battery will cause low power conditions
- Set your radio to high power

**Note:** Some channels are restricted by the FCC to low power.

## OPERATING YOUR RADIO

### POWER ON / OFF AND VOLUME

1. Rotate the Power / Volume knob clockwise to turn on the radio and increase the volume.
  - a. During power on, the radio will sound a power-up tone sequence (unless Silent mode is selected).
  - b. The radio will return to the last channel used when powered on.
2. Rotate the Power / Volume knob counterclockwise to decrease the volume and turn off the radio.

### VOICE COMMUNICATION

To communicate, radios must be set to the same channel and privacy code.

1. For maximum clarity, hold the radio 2 to 3 inches from your mouth.
2. Press and hold the PTT button and speak in a normal voice into the microphone. The TX / RX indicator LED will be red when your radio is sending a transmission.
3. The TX / RX indicator LED will be green when your radio is receiving a transmission.

## CHANNEL SELECTION

1. Briefly press the Menu button, then use the Up / Down arrow buttons to select one of the GMRS channels or repeater channels (when enabled).
2. Press the PTT button to confirm the setting and resume normal radio operation.

## DISPLAY ILLUMINATION

The display will automatically illuminate when the radio is first turned on, at the start of a new RX or TX activity, and when buttons are pressed. The display will automatically turn off.

## KEYPAD FUNCTION

The following functions can be directly accessed through the radio keypad.

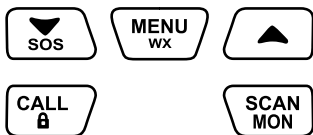

**NOTE:** Upper functions are activated by **short press** of the button.

Lower functions are activated by **press and hold** of the button, Example:

To activate SCAN, press and release the button momentarily.

To activate MON, press and hold the button for 3 seconds.

## CALL ALERT

The GXT67 PRO can send a “Call Tone” (direct call) to other radios to alert them you are about to transmit. Make sure call alert is turned on and a call tone is selected using the MENU function.

1. Briefly press the CALL / LOCK button to transmit a call alert.
2. The TX Icon will illuminate as the call alert is transmitted.

## KEYPAD LOCK

The keypad can be locked to prevent accidental changes to the settings. You can transmit / receive voice transmissions, use call alert, and activate the SOS siren while the keypad is locked.

1. Press and hold the CALL / LOCK button for 3 seconds to lock / unlock the keypad.

## WEATHER

The GXT67 PRO has a NOAA Weather Alert Radio built in. You can listen for current weather conditions or set it to automatically alert you to impending severe weather events or other civil emergencies. It also has automated NOAA Weather Radio scanning that will check the weather channels and automatically lock onto a weather channel with good broadcast signal.



- The radio must be set to a weather channel with good signal in your area for the weather alert feature to work correctly.
  - Check with your local NWS office or go to the NWS website at [https://www.weather.gov/nwr/station\\_listing](https://www.weather.gov/nwr/station_listing) to find your frequency. Use the chart to locate the weather channel setting number to be programmed into the radio.
- \* Canadian Marine Frequencies.

Channel	Frequency
1	162.550
2	162.400
3	162.475
4	162.425
5	162.450
6	162.500
7	162.525
8*	161.650
9*	161.775
10*	163.275

### Weather Icon

When the WX icon is on, solid (not blinking) it indicates that the radio is prepared for receiving alerts that are issued by tone alert over NOAA Weather Radio (NWR). Regardless of the radio's mode of operation, a WX icon that is on without blinking means that weather alert is enabled **and** the currently selected weather channel's signal is strong enough to receive alerts.

In GMRS mode, a blinking WX icon means that weather alert is enabled, but the signal on the currently selected weather channel is **not** good enough to receive alerts.

During weather modes, the WX icon will also remain on or blink, based upon whether or not the radio is prepared for receiving alerts.

## Weather Modes Navigation

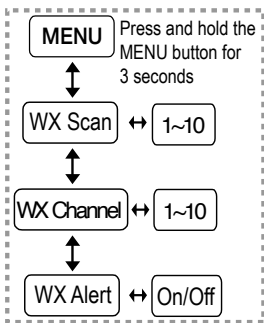

From GMRS mode, press and hold the Menu / Weather button for 3 seconds to enter Weather Scan mode. Press Menu / Weather again for manual weather channel selection to set and listen to a selected weather channel. Press Menu / Weather again to advance to Weather Alert On / Off Selection. Pressing Menu / Weather will advance back to the start of weather modes (Weather Scan) and pressing PTT during Weather Alert selection will go "back" (to manual weather channel selection). Pressing PTT during Weather Scan and manual weather channel selection exits "back" to GMRS mode.

## Weather Scan Mode

1. The radio will stop scanning on the first usable signal in your area and you will hear the NWR broadcast on that Weather channel.
2. The radio will automatically rescan if the weather channel signal becomes too weak. If you want to manually restart a Scan for a another weather channel signal, press the Up ▲ or Down ▼ button.

## Manual WX Channel Selection

1. Use the Up ▲ or Down ▼ button to select the desired weather channel (see guidance for selecting a weather channel above). You will hear the NWR broadcast on that weather channel.

## Weather Alert On / Off Selection

1. Use the Up ▲ or Down ▼ button to select Weather Alert On (enabled) or Weather Alert Off (disabled).

## Weather Alerts

When on / enabled, weather alerts can be received in both GMRS and Weather modes. Upon receiving a weather alert:

1. The radio will sound a weather alert notification tone sequence
2. The weather icon will blink rapidly
3. The radio will switch to the weather channel display

Press any button to acknowledge the Weather Alert and stop the notification tones. After the alert is acknowledged, the NWR broadcast will be heard. Use the PTT or Menu / Weather buttons to exit or change the weather modes.

If the weather alert is not acknowledged after about 20 seconds, the radio will automatically stop the notification tones and switch to the NWR broadcast, but the weather icon will continue blinking rapidly to indicate there has been a Weather Alert. Press any button to acknowledge the Alert, then use PTT or Menu / Weather to exit or change weather modes.

## CHANNEL SCAN

1. Briefly press the Scan / Monitor button to turn Scan on or off.
2. The radio will rapidly scan through the selected channels stopping briefly on a channel in use to hear the conversation.

**NOTE:** Each channel can be configured to include in channel scan or to skip when scanning.

1. Select RADIO OPTIONS from the top menu and press the MENU button.
  2. Select SCAN SELECT in the RADIO OPTIONS menu, and press the MENU button.
  3. There are 2 “bulk” operations available before proceeding to per-channel Scan / Skip selections.
    - Select SCAN ALL and press MENU if you want to scan all, or most, of the channels. Then proceed to select SKIP for any channels you want to exclude from scanning.
    - Select SKIP ALL and press MENU if you want to scan just a few channels. Then proceed to select SCAN for the channels you want to include in scanning. Note that channel scan will not be performed unless 2 or more channels are selected to Scan.
  4. After doing SCAN ALL or SKIP ALL operations, or after pressing MENU with SELECT CHANNELS selected, Channel 1 is displayed with its current selection. For each channel, press MENU to advance to the next channel after selecting the SKIP or SCAN for the channel. Press PTT to go “back” if you do not need to advance through all the remaining channels.
3. You may join the conversation by pressing the PTT button and using the radio normally.
  4. The radio will return to scanning after 5 seconds of inactivity.

## MONITOR

- Press and hold the Scan / Monitor button for 3 seconds to turn monitor on or off.
  - Monitor is used to check for channel traffic before you transmit.

## SOS SIREN

The GXT67 PRO can sound a loud siren to alert others you need assistance.

- Press and hold the Down Arrow / SOS button for 3 seconds to activate the SOS siren. To stop the SOS siren, **double-press** PTT.

## MENU

See the sections below on how to access more features and configure the radio using the Menu button.

## GENERAL MENU NAVIGATION GUIDE

From GMRS mode, pressing Menu provides for channel selection as described above. Pressing Menu again enters the top menu for advanced functions and radio configuration. Reception of transmissions from other radios and reception of weather alerts is inhibited during Menu operations.

### Top Menu

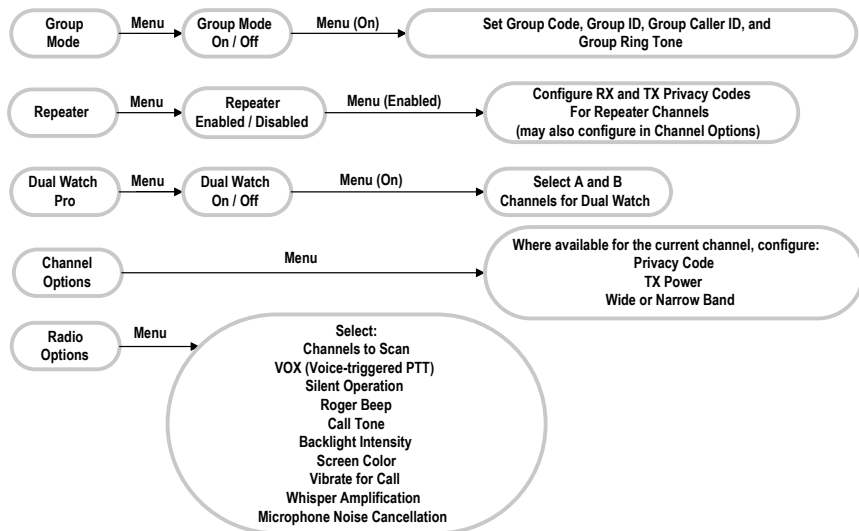

Make menu and configuration selections using the buttons as follows:

1. The Menu button performs Forward / Next operations. Pressing Menu accepts and saves any changes and proceeds to the next menu level or the next selection item. If already at the lowest menu level or the last selected item, pressing Menu accepts any changes and returns to the prior menu level. One exception is with Dual Watch Pro, where pressing Menu after the last selection item exits menus to perform Dual Watch Pro scanning in GMRS mode.
2. The PTT button performs Back / Exit operations. Pressing PTT accepts and saves any changes, and goes back to the prior menu level. At the top menu, PTT exits to GMRS mode.
3. The Up and Down buttons change the menu, function, or configuration option selection.

**NOTE:** If there is no button activity for about 10 seconds during Menu operation, changes to advanced feature or option selections will be saved and the Menu will automatically exit to GMRS mode.

## GROUP MODE

In group mode, you can set up groups of radio users so that you can do a group call alert to only one group, or all groups with the same group code. Voice communications are heard by all groups using the same group code, but with group call you can identify yourself as the caller and alert the group(s) you call that the communication is specifically meant for them.

1. To use group mode, you must first
  1. Turn Group mode operation on
  2. Set up a Group code
  3. Set the radio's Group number / Group ID
  4. Set the Group caller ID
  5. Set the Group
2. While operating in group mode, the GROUP icon is displayed along with the group ID number and group code number for easy reference.

- To communicate between radios in Group Mode, the radios must be set to the same channel and Group Code selections.
- Make note of the settings used while setting up GROUP MODE so others can identify you and call your Group.
- Leave GROUP MODE off to keep the radio in normal "GMRS" mode and include radios without GROUP MODE.
- Repeaters are not compatible with Group Mode operation. Repeater channels will not be available while using Group Mode.



**SET THE RADIO TO GROUP MODE**

1. Set the radio to a channel between 1 and 22.
2. Select GROUP MODE from the Top Menu.
3. Use the Up / Down arrow to either turn group mode on or off.
4. Press MENU to advance to the next setting, GROUP CODE.

**SET A GROUP CODE**

1. After selecting group mode on, press Menu to set the group code.
2. Use the Up / Down arrow button to select one of the 143 group codes (0 – 142).
3. Press MENU again to advance to the next setting, GROUP ID.

**SET A GROUP ID**

1. Once the GROUP CODE is set, press menu to set the GROUP ID.
  - a. "ID" will be shown on the display with the code digits flashing to the right.
2. Use the UP / DOWN arrow to select one of the 10 group numbers / group IDs.
3. Press MENU to advance to the next setting, Group Caller ID.

**SET A GROUP CALLER ID**

1. After the GROUP ID is set, press Menu to set your Group CALLER ID.
  - CALLER ID will identify you as the caller when transmitting a Group Call.
  - CALLER ID is a 4-digit number selected by the user.
2. The first digit in the display will be flashing. Use the Up / Down arrow button to select the first digit of your CALLER ID.
3. Press the SCAN / MON button to advance to the next digit. Use the Up / Down arrow to make the selection.
4. Repeat step 3 until all 4 digits are set.
5. Press MENU to advance to the next setting, GROUP RING TONE.

**SET A GROUP RING TONE**

1. After the CALLER ID is set, press Menu to set your RING TONE.
  - Your RING TONE will sound when you receive a Group Call.
2. Use the UP / DOWN arrow button to select one of the 5 group ring tones.



## MAKING A GROUP CALL

Group call allows you to do a group call alert to only one group, or all groups with the same group code.



- You must be in group mode for group call to function.
- Only radios set to the same channel and group code will receive your group call.

1. While in Group Mode, press the CALL / LOCK button.
2. Use the UP / DOWN arrow buttons to select a specific Group Number / Group ID to receive your call, or select "ALL" Groups to receive the call.
3. Press CALL / LOCK again to send the call to only the selected Group.

## REPEATER OPERATION

The GXT67 Pro can access a national network of repeaters that can extend the range of the radio when using repeater channels 15 - 22. Repeater channels operate with different reception and transmission frequencies.

1. Select REPEATER from the Top Menu and press the MENU button.
2. Use Up / Down to select whether Repeater Channels will be available for use (Enabled) or not available for use (Disabled).
3. When MENU is pressed with Repeaters ENABLED, a sub-menu for configuring Repeater Channels is provided.
4. For each repeater channel (RPTR 15 through RPTR 22), separate receive (RX) and transmit (TX) privacy codes may be selected. Select the repeater channel you want to configure and press MENU, then select privacy codes as described in the SETTING PRIVACY CODES section - first for the RX Privacy Code, then for the TX Privacy Code.



- Repeaters are not compatible with Group Mode operation. Repeater channels will not be available while using Group Mode.

## SETTING PRIVACY CODES

When not in group mode and on a channel that supports it, you can select from one of the 142 Privacy codes to increase privacy and reduce interference on a channel.



- You can only select a privacy code when GROUP MODE is off and for channels 1-22 or repeater channels 15 - 22.
  - Channels 23-50 have preset privacy codes that cannot be changed.
  - Group mode settings supersede privacy code settings.
- Repeater channels provide for “Split Tones” – selection of separate Receive and transmit privacy codes, which may be the same or different.
- Select from 38 CTCSS, 104 DCS codes, or OFF for each channel.
  - Radio with privacy codes off will disable this function, increasing interference and reducing privacy.
- The selected privacy code can be different for each channel.
- Radios must be using the same privacy code and channel to work together.

1. Select Channel Options (CHAN OPTIONS) from the Top Menu and press the MENU button.
2. Select PRIVACY CODE in the CHAN OPTIONS menu, and press the MENU button.
3. Select OFF to stop using a privacy code on the channel, or select either CTCSS or DCS type of Privacy Code to use, and press the MENU button.
4. After selecting CTCSS or DCS, select the specific code you want to use.
5. Press Menu to accept the setting and return to the CHAN OPTIONS menu.

## BANDWIDTH

You can choose between using wide or narrow bandwidth on each of the channels 1-7, 15-22, and repeater 15 - 22. All other channels are preset to Narrow band.



- Narrowband may reduce effects of interference in some situations and is the best setting for operating with FRS-only radios.
- Wideband may improve voice quality and is the setting used by most repeaters.
- For best results, make sure transmitting and receiving radios both use the same bandwidth setting.

1. Select Channel Options (CHAN OPTIONS) from the Top Menu and press the MENU button.
2. Select BAND in the (CHAN OPTIONS) menu, and press the MENU button.
3. Use the Up / Down Arrow to select Wide or Narrow Band
4. Press Menu to accept the setting and return to the CHAN OPTIONS menu.

## TRANSMIT (TX) POWER

You can select from 3 power levels on each of the channels 1-7, 15-33, 38-50, and repeater 15 - 22. Channels 8-14 and 34-37 are limited to low power by FCC rules.

- Lower power will reduce range, but increase battery life.
- Higher power will increase range, but reduce battery life.

**NOTE:** If the battery charge level is not adequate for transmitting at the configured power level, the radio will automatically “fall back” to use a lower TX power level during transmission. The TX Power icon will blink and show the TX power level being used for the transmission.

1. Select Channel Options (CHAN OPTIONS) from the Top Menu and press the MENU button.
2. Select TX POWER in the CHAN OPTIONS menu, and press the MENU button.
3. Use the Up / Down Arrow to select between LOW, MEDIUM, or HIGH transmission power.
4. Press Menu to accept the setting and return to the CHAN OPTIONS menu.

## VOX

Voice Operated Transmission (VOX) provides for hands-free operation by transmitting when you speak into the microphone and without pressing the PTT button. You can select between 4 sensitivity levels for VOX. You can think of the VOX sensitivity number as, “how loud I need to speak to activate transmission.” The default VOX setting is off.

- The lower the sensitivity number, the easier the radio will respond to your voice, but will also increase background noise and accidental transmissions.
- The higher settings reduce the likelihood of an accidental transmission, but also require you to speak louder into the radio microphone to transmit.

1. Select RADIO OPTIONS from the Top Menu and press the MENU button.
2. Select VOX in the RADIO OPTIONS menu and press the MENU button.
3. Use the Up / Down Arrow to select between 4 sensitivity levels or “OFF”.
4. Press Menu or PTT to accept the setting and return to the RADIO OPTIONS menu.

## **SILENT OPERATION/BUTTON BEEPS**

Silent operation suppresses tones generated by the radio including button feedback and low battery beeps. It does not affect SOS tones. It also does not affect tones received in transmissions from other radios.

1. Select RADIO OPTIONS from the Top Menu and press the MENU button.
2. Select SILENT in the RADIO OPTIONS menu and press the MENU button.
3. Use the Up / Down Arrow to turn the Button Beeps on or off.
4. Press Menu or PTT to accept the setting and return to the RADIO OPTIONS menu

## **ROGER BEEP**

When Roger Beep is on, the radio will transmit a tone to other radios when you release the PTT to confirm you have ended your transmission and others may begin.

1. Select RADIO OPTIONS from the Top Menu and press the MENU button.
2. Select ROGER BEEP in the RADIO OPTIONS menu and press the MENU button.
3. Use the Up / Down Arrow to turn Roger Beep on or off.
4. Press Menu or PTT to accept the setting and return to the RADIO OPTIONS menu

## **CALL ALERT TONE SELECTION**

Select the call alert tones that you want to sound when you transmit a Direct Call.

1. Select RADIO OPTIONS from the Top Menu and press the MENU button.
2. Select CALL TONE in the RADIO OPTIONS menu and press the MENU button.
3. Use the Up / Down Arrow to select Off (to disable sending call alerts) or to select from one of the 10 different Call Tones.
4. Press Menu or PTT to accept the setting and return to the RADIO OPTIONS menu.

## **BACKLIGHT SELECTION**

Select the LCD screen backlight intensity that you want, or turn the LCD screen backlight off. Note the button backlight is unaffected by this setting.

1. Select RADIO OPTIONS from the Top Menu and press the MENU button.
2. Select BACKLIGHT in the RADIO OPTIONS menu and press the MENU button.

3. Use the Up / Down Arrow to either turn the backlight off or select from the 5 levels of backlight brightness.
4. Press Menu or PTT to accept the setting and return to the RADIO OPTIONS menu.

## **SCREEN COLOR SELECTION**

Select the screen color that you want.

1. Select RADIO OPTIONS from the Top Menu and press the MENU button.
2. Select SCREEN COLOR in the RADIO OPTIONS menu and press the MENU button.
3. Use the Up / Down Arrow to select the LCD screen backlight color.
4. Press Menu or PTT to accept the setting and return to the RADIO OPTIONS menu.

## **VIBRATE ALERT**

Vibrate alert will vibrate the radio instead of sounding tones to alert you when receiving a direct call or group call from another radio that is compatible with your radio's vibrate function. The other, calling radio does not need to be set for Vibrate in order for you to choose vibrate alerting for your radio.

1. Select RADIO OPTIONS from the Top Menu and press the MENU button.
2. Select VIBRATE in the RADIO OPTIONS menu and press the MENU button.
3. Use the Up / Down Arrow to turn Vibrate Alert On or Off.
  - The Vibrate Alert icon will remain on when the function is activated.
4. Press Menu or PTT to accept the setting and return to the RADIO OPTIONS menu.

## **WHISPER MODE**

Whisper mode allows you to speak softly into your microphone, but transmit at a higher voice volume level.

1. Select RADIO OPTIONS from the Top Menu and press the MENU button.
2. Select WHISPER in the RADIO OPTIONS menu and press the MENU button.
3. Use the Up / Down Arrow to turn whisper mode On or Off.
  - The WI Icon will remain on when the function is activated.
4. Press Menu or PTT to accept the setting and return to the RADIO OPTIONS menu.

## **MICROPHONE NOISE CANCELLATION**

Active Noise Cancellation (ANC) can be applied to the sound detected by the microphone before transmitting it to other radios.

- When on, ANC works to 'keep' sounds with the characteristics of voice, but suppress sounds interpreted as background noise. This is most helpful for keeping your voice understandable when you are in a loud environment. However, ANC may suppress desired sounds if you want receiving radios to hear other voices or sounds occurring around you.
  - When off, the radio will not suppress sounds detected by the microphone. This is most helpful when transmitting in a quiet environment or when you want receiving radios to hear other voices and sounds occurring around you. However, the background sounds may make it harder to understand what you are saying.
1. Select RADIO OPTIONS from the top menu and press the MENU button.
  2. Select TX NOISE CANCEL in the RADIO OPTIONS menu, and press the MENU button.
  3. Use Up / Down to select ANC as enabled (ON) or disabled (OFF).
  4. Press Menu or PTT to accept the setting and return to the RADIO OPTIONS menu.

## DUAL WATCH PRO

Dual Watch Pro allows you to scan 2 channels for activity. One channel will be used as the primary channel and one channel will be used as the secondary channel. The display will show the primary channel while actively scanning, and will display the active channel when scan is stopped for activity. Pressing PTT while scanning (while not stopped for activity on a channel) will transmit on the primary channel. Pressing PTT while stopped on an active channel will transmit on the active channel.



**Note:** Dual Watch Pro operation is not available while in Group Mode. Exit Group Mode in order to use Dual Watch Pro.

1. Select "DUAL WATCH PRO".
2. Select ON and press the MENU button.
3. Select the channel you want to use as the Dual Watch 'A' channel (DW A), then press MENU.
4. Select the channel you want to use as the Dual Watch 'B' channel (DW B), then either press MENU or exit the menu (using PTT) to start Dual Watch scanning.



**Note:** Dual Watch 'A' will be used as the Primary Channel when Dual Watch scanning starts.

5. During Dual Watch Pro Mode:
  - You can swap which channels are primary (A) and secondary (B) by pressing the Up or Down arrow while scanning.
  - The radio will stop scanning when a transmission is received.
  - Press the PTT to join the conversation.
  - The radio will resume Dual Watch Pro scanning after 5 seconds of inactivity.
6. Press the SCAN button to turn Dual Watch Pro scanning off. You can also turn Dual Watch Pro scanning off by entering the DUAL WATCH PRO menu and selecting OFF.

## RESTORING DEFAULT SETTINGS AND OPERATION

You can return your GXT67 PRO to the factory default settings and operation at any time.

1. Switch the radio off
2. Press and hold the PTT and Menu/Weather buttons simultaneously with the radio off
3. Switch the radio on and release the buttons when RESET is displayed

## TROUBLESHOOTING GUIDE

PROBLEM	SOLUTION
No Power	- Check battery charge
Cannot Receive Messages	- Confirm the radios have the same channel frequency and privacy code settings. - Make sure that you are within range of the other transceivers. - Buildings and other structures may interfere with your communication. - <b>(See ABOUT RANGE on Page 9)</b>
Radio is not responding to button presses	- Make sure key lock is not on. - <b>(See KEYPAD LOCK on Page 10)</b>
Display is dim	- Some extreme temperature conditions may result in a slow display response or a dim display. Avoid operating the radio at extreme temperatures whenever possible. - Recharge the battery.
Charger not functioning	- Contacts on the bottom of the radio may require cleaning. - Ensure the outlet where the charger is plugged in is functioning properly.

*If you have a problem that you believe requires service, reach out to support@midlandusa.com.*

**IMPORTANT:** Changes or modifications to this unit not expressly approved by MIDLAND RADIO CORP. could void your right to operate this unit. Your radio is set up to transmit a regulated signal on an assigned frequency. It is against the law to alter or adjust the settings inside the DEVICE to exceed those limitations. Any Adjustment to your radio must be made by qualified technicians.

## USE AND CARE

1. Use a soft damp cloth to clean the radio
2. **Do not** use alcohol or cleaning solutions to clean the radio.
3. **Do not** immerse the radio in water.
4. Dry the radio with a dry lint-free cloth should it get wet.



## SPECIFICATIONS

**Channels:** 22 GMRS Channels + 142 Privacy Codes  
 28 Midland Preset Channels  
 8 Repeater Channels  
 10 NOAA Weather (WX) Band Channels

**Operating Frequency:** UHF 462.5500 ~ 467.7125 MHz

**Power Source:** 7.4V 2500mAh Li-Ion Battery

## GMRS FREQUENCY CHART (MHz)

Channel Number	Channel Frequency	Channel Number	Channel Frequency	Channel Number	Channel Frequency
1	462.5625	9*	467.5875	17	462.6000
2	462.5875	10*	467.6125	18	462.6250
3	462.6125	11*	467.6375	19	462.6500
4	462.6375	12*	467.6625	20	462.6750
5	462.6625	13*	467.6875	21	462.7000
6	462.6875	14*	467.7125	22	462.7250
7	462.7125	15	462.5500		
8*	467.5625	16	462.5750		

\*Channels 8 -14 and 34 - 37 are low-power GMRS channels

Midland Presets Channel	Frequency	GMRS Channels	Privacy Code	Midland Presets Channel	Frequency	GMRS Channels	Privacy Code
23	462.5625	1	CTCSS 38	37*	467.7125	14	DCS 19
24	462.6125	3	CTCSS 35	38	462.5750	16	DCS 22
25	462.6625	5	CTCSS 32	39	462.6250	18	DCS 25
26	462.7125	7	CTCSS 29	40	462.6750	20	DCS 28
27	462.5500	15	CTCSS 26	41	462.7250	22	DCS 31
28	462.6000	17	CTCSS 23	42	462.5625	1	CTCSS 14
29	462.6500	19	CTCSS 20	43	462.6125	3	CTCSS 11
30	462.7000	21	CTCSS 17	44	462.6625	5	CTCSS 8
31	462.5875	2	DCS 1	45	462.7125	7	CTCSS 5
32	462.6375	4	DCS 4	46	462.5500	15	CTCSS 2
33	462.6875	6	DCS 7	47	462.6000	17	CTCSS 37
34*	467.5625	8	DCS 10	48	462.6500	19	CTCSS 34
35*	467.6125	10	DCS 13	49	462.7000	21	CTCSS 31
36*	467.6625	12	DCS 16	50	462.5875	2	DCS 2

## GMRS REPEATER FREQUENCY CHART

Channel Number	TX Frequency	RX Frequency
RP15	467.5500	462.5500
RP16	467.5750	462.5750
RP17	467.6000	462.6000
RP18	467.6250	462.6250
RP19	467.6500	462.6500
RP20	467.6750	462.6750
RP21	467.7000	462.7000
RP22	467.7250	462.7250

**NOAA WEATHER (WX) RADIO FREQUENCY CHART (MHz)**

CH. No	CH. Freq	CH. No	CH. Freq
1	162.550	6	162.500
2	162.400	7	162.525
3	162.475	8*	161.650
4	162.425	9*	161.775
5	162.450	10*	163.275

\*Channels 8, 9 and 10 are designated Canadian Marine Frequencies.

**CTCSS PRIVACY CODES FREQUENCY CHART (MHz)**

Code	Freq.	Code	Freq.	Code	Freq.	Code	Freq.	Code	Freq.
1	67.0	9	91.5	17	118.8	25	156.7	33	210.7
2	71.9	10	94.8	18	123.0	26	162.2	34	218.1
3	74.4	11	97.4	19	127.3	27	167.9	35	225.7
4	77.0	12	100.0	20	131.8	28	173.8	36	233.6
5	79.7	13	103.5	21	136.5	29	179.9	36	241.8
6	82.5	14	107.2	22	141.3	30	186.2	38	250.3
7	85.4	15	110.9	23	146.2	31	192.8		
8	88.5	16	114.8	24	151.4	32	203.5		

**DCS PRIVACY CODE CHART**

No.	CODE	No.	CODE	No.	CODE	No.	CODE	No.	CODE
1	023	22	143	43	315	65	546	87	145
2	025	23	152	44	331	66	565	88	212
3	026	24	155	45	343	67	606	89	225
4	031	25	156	46	346	68	612	90	246
5	032	26	162	47	351	69	624	91	252
6	043	27	165	48	364	70	627	92	255
7	047	28	172	49	365	71	631	93	266
8	051	29	174	50	371	72	632	94	274
9	054	30	205	51	411	73	654	95	325
10	065	31	223	52	412	74	662	96	332
11	071	32	226	53	413	75	664	97	356
12	072	33	243	54	423	76	703	98	446
13	073	34	244	55	431	77	712	99	452
14	074	35	245	56	432	78	723	100	454
15	114	36	251	57	445	80	732	101	455
16	115	37	261	58	464	81	734	102	462
17	116	38	263	59	465	82	743	103	523
18	125	39	265	60	466	83	754	104	526
19	131	40	271	62	506	84	036		
20	132	41	306	63	516	85	053		
21	134	42	311	64	532	86	122		

## ACCESSORIES

Accessories can be purchased at [midlandusa.com](http://midlandusa.com).

### AVP-1



- 2 Over the Ear Mic. Headsets w/ PTT

### AVP-H2



- 1 Closed Face Helmet Microphone Kit

### AVP-H3



- 2 Surveillance Headset

### AVP-H4



- 2 Ear Wrap Headset

### AVP-H5



- 2 Behind the Head Headset

### AVP-H7



- 2 Mossy Oak Around the Ear Headsets with Boom Mic

### AVP-H8



- 2 Surveillance Headset

### AVP-H10



- 1 Action Throat Mic with Acoustic Ear Tube

## LIMITED WARRANTY

Midland will repair or replace, at its option without charge, any Midland GMRS transceiver which fails due to a defect in material or workmanship within 3 years following the initial consumer purchase.

This warranty does not apply to water damage, battery leak, or abuse. Accessories have a 90-day warranty from date of purchase, including any antennas, chargers, or earphones.

This warranty does not include the cost of labor for removal or re-installation of the product in a vehicle or other mounting.

### **For Product Purchased in the USA:**

Performance of any obligation under this warranty may be obtained by returning the warranted product, prepaid freight, along with proof of purchase to:

**Midland Radio Corporation  
Warranty Service Department  
5900 Parretta Drive  
Kansas City, MO 64120**

This warranty gives you specific legal rights, and you may also have other rights, which vary from state to state.

Note: The above warranty applies only to merchandise purchased in the United States of America or any of the territories or possessions thereof, or from a U.S. Military exchange.

### **For Product Purchased in Canada:**

Performance of any obligation under this warranty may be obtained by returning the warranted product, along with proof of purchase, to your dealer in Canada.

This warranty gives you specified legal rights. Additional warranty rights may be provided by law in some areas.



We'd love to hear from you! Let us know what you think of your new Midland product at



or by visiting us at  
MIDLANDUSA.COM



**Note:** Features & Specifications are subject to change without notice .MIDLAND is not responsible for unintentional errors or omissions on its packaging. MIDLAND promotes environmental sustainability by providing battery recycling. Call 1.800.822.8837 for the nearest drop off site to you.