

INSTALLATION GUIDE

ALUMINA TABLE LAMP

Thoughtful lighting, responsibly designed in London.

Thank you for making the switch to Tala.
Discover the full Tala family at tala.co.uk.

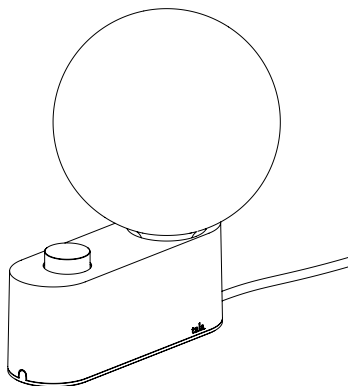

BEFORE STARTING

Please read instructions thoroughly before installation and keep them for future reference. Please take extreme care when dealing with electrical equipment.

IMPORTANT

Bulb must be installed in fixture before turning on.

WARNING

Incorrect assembly may result in risk of fire or electric shock.

CARE AND CLEANING

We recommend cleaning with a soft dry cloth. Do not use abrasive materials as these will damage the finish of the product.

AFTER-CARE

Please note, the flexible cable attached to this luminaire cannot be replaced; if the cable is damaged, recycle the luminaire and seek a replacement.



Scan me for more technical help

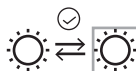

SKU - ALM-SPHR-IV-SAP-TBL-01-EU
SKU - ALM-SPHR-IV-SGE-TBL-01-EU
SKU - ALM-SPHR-IV-BLS-TBL-01-EU
SKU - ALM-SPHR-IV-CHK-TBL-01-EU
SKU - ALM-SPHR-IV-CHR-TBL-01-EU

FOR INDOOR USE ONLY



Table Configuration

STEP 1

Insert your bulb into the top of the lamp, rotating clockwise until tight. Take care not to tighten too much to avoid breakage.

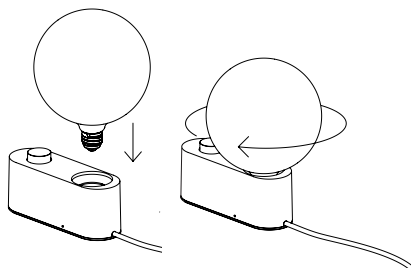

STEP 2 - FOR UK ONLY

Insert the EU plug into the UK Adapter, making sure it clicks-in and does not come loose.

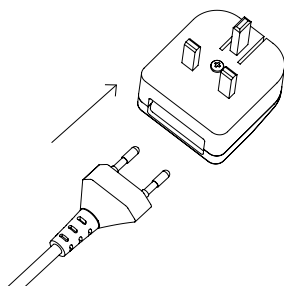

STEP 3

Insert the lamp plug into your chosen wall socket, making sure the power is switched off.

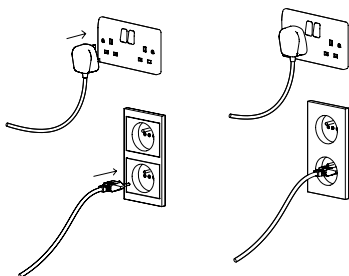

STEP 4

Switch the power on and rotate the dial on your dimmer until the bulb lights up. Adjust the dimmer for your desired light output.

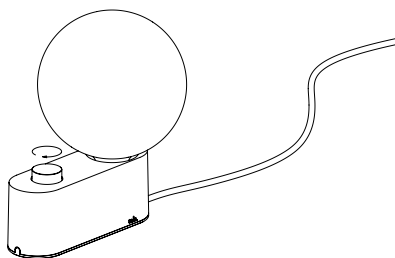

Wall Configuration

STEP 1

Remove your bulb from the lamp, rotating counter clockwise and set aside.

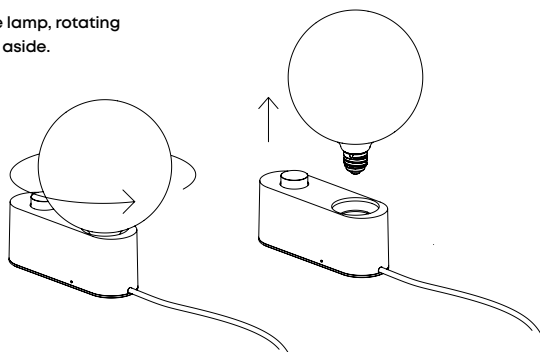

STEP 2

Remove the small lock screw from the side of the lamp with the hex key provided.

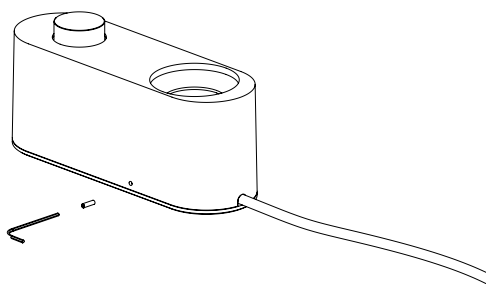

STEP 3

Slide the lamp towards the cable to disconnect it from the base.
Lift the lamp and set it aside.

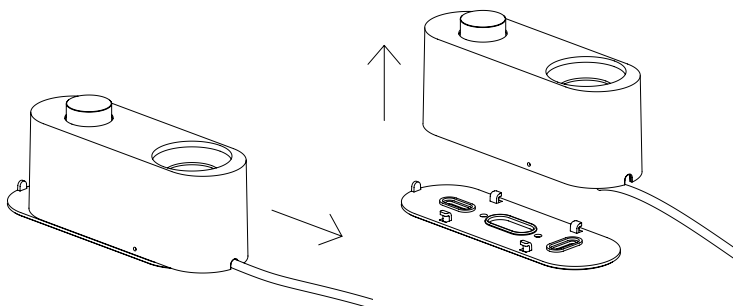

Wall Configuration

STEP 4

Attach the base to your wall in the orientation shown below. Always choose screws and plugs that are appropriate for the wall.

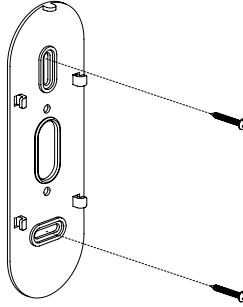

STEP 5 (OPTIONAL)

Customers who wish to hard wire the product into the household mains. Please consult a qualified electrician to perform this modification. Junction boxes are not provided.

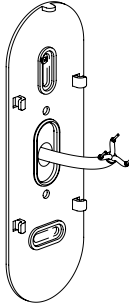

STEP 6

Move the cable from the top to the bottom opening.

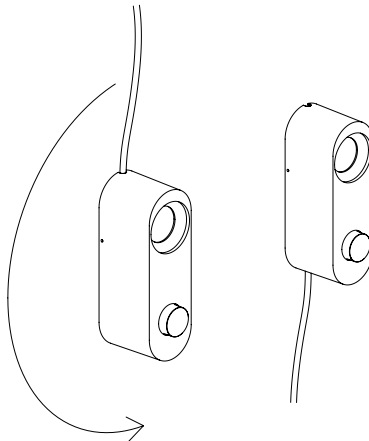

Wall Configuration

STEP 7

Align the lamp above the base and slide down to lock in place .

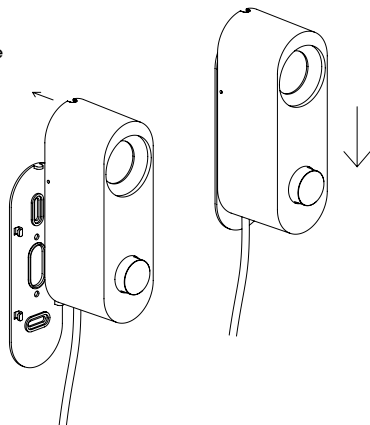

STEP 8

Insert your bulb into the front of the lamp, rotating clockwise until tight. Take care not to tighten too much to avoid breakage.

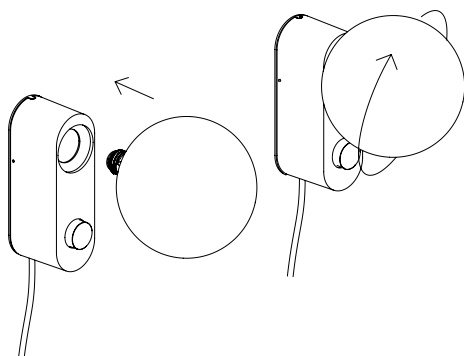

STEP 9

Re-attach the lock screw using the hex tool provided.

Tighten until flush with the outside surface of the lamp . Over-tightening may result in the screw becoming lost inside the lamp.

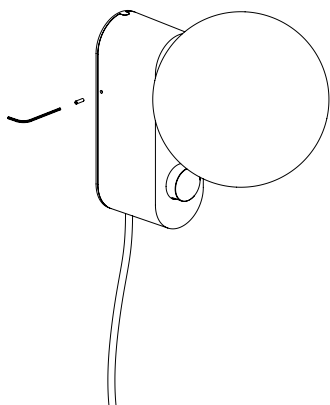

Wall Configuration

STEP 10 - FOR UK ONLY

Insert the EU plug into the UK Adapter, making sure it clicks-in and does not come loose.

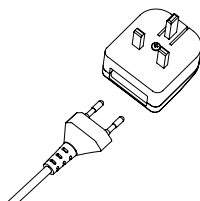

STEP 11

Insert the lamp plug into your chosen wall socket, making sure the power is switched off.

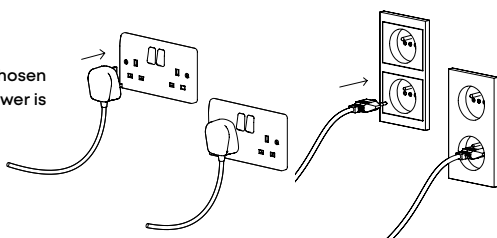

STEP 12

Switch the power on and rotate the dial on your dimmer until the bulb lights up. Adjust the dimmer for your desired light output.

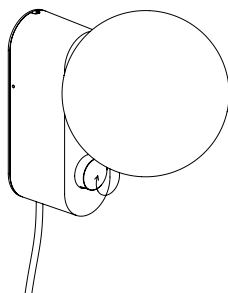

WARRANTY AND AFTER-CARE

This product has a two-year warranty. If there appears to be a functional defect with the product during this time, please contact our team at customerservice@tala.co.uk.

Join the Community

Instagram: @tala | Facebook: talaHQ | Pinterest: TalaLED | Tag: lighttoliveby
Tala Studios, 25B Vyner Street, London E2 9DG | +44 20 3026 3246 | hello@tala.co.uk
Tala Europe B.V, Bertus Aafjeshove 40, Nieuwegein 3437JN, Netherlands