



Air Flow Switches

Series AF1

- For general purpose applications with medium and high velocity requirements

Series AF2

- For low velocity applications

Series AF3

- For general purpose low velocity applications where the most economical flow switch is desired

Series AFE-1

- For industrial hazardous environment applications requiring a **NEMA 7 (Class 1, Division 1, Group C and D) or NEMA 9 (Class II, Division I, Group E, F, and G)** rate flow switch for medium velocity.

Application

Air flow switches provide an economical way to detect change or loss of air flow velocity caused by a closed damper or fan inlet, a loose fan wheel, a slipped or broken fanbelt, a dirty or clogged filter, or an overload on a fan motor switch.

Electrical Ratings

Voltage	Motor Switch Rating (Amperes)		Pilot Duty
	Full Load	Locked Rotor	
120 VAC	7.4	44.4	125 VA at 120 or 240 VAC 50 or 60 cycles
240 VAC	3.7	22.2	

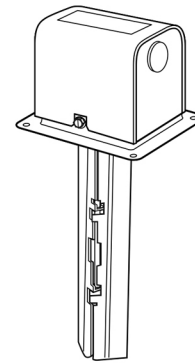

Series AF1

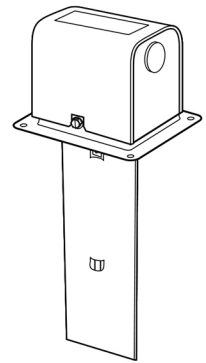

Series AF2

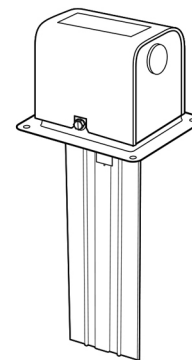

Series AF3

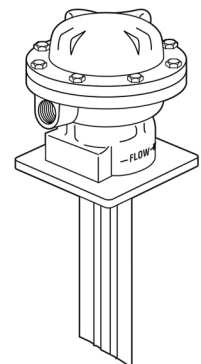

Series AFE-1

WARNING



- Before using this product read and understand instructions.
- Save these instructions for future reference.
- All work must be performed by qualified personnel trained in the proper application, installation, and maintenance of plumbing, steam, and electrical and/or systems in accordance with all applicable codes and ordinances.
- To prevent electrical shock, turn off the electrical power before making electrical connections.
- To prevent an electrical fire or equipment damage, electrical wiring insulation must have a rating of 167°F (75°C) if the liquid's temperature exceeds 180°F (82°C).
- To prevent electrocution, when the electrical power is connected to the flow switch, do not touch the terminals.
- Make sure flow switch electrical cover is secured before turning on electric power.
- This product can expose you to chemicals including Lead and Hexavalent Chromium, which are known to the State of California to cause cancer and birth defects or other reproductive harm. For more information go to: www.P65Warnings.ca.gov.
- Previous controls should never be installed on a new system. Always install new controls on a new boiler or system.



Failure to follow this warning could cause property damage, personal injury or death.

CAUTION:

- A more frequent replacement interval may be necessary based on the condition of the unit at time of inspection. McDonnell & Miller's warranty is one (1) year from sate of installation or two (2) years from the date of manufacture.

INSTALLATION

IMPORTANT

The switch should be located about 10 duct diameters downstream from a fan, or 7 diameters downstream from an elbow or any other cause of turbulence.

RECOMMENDED INSTALLATION POSITIONS

The Model AF1, AF1-S, AF2, AF3, and AF3-D Air Flow Switch may be installed in any position. Interior dimensions of the duct must be sufficient to accommodate the paddle. Standard paddle fits into 8" minimum duct size; 2" may be trimmed from end of paddle to fit into ducts as small as 6".

Maximum Ambient Temperature – 120°F (50°C)

LOCATION

When ever possible, the Air Flow Switch should be installed in a horizontal duct. Avoid downstream locations too close to elbows, dampers, fans, or other areas of excessive turbulence.

Flow rates required to actuate the Air Flow Switch at minimum and maximum adjustments are shown below. All switches are shipped from the factory set at minimum adjustment.

MAXIMUM DUCT TEMPERATURE

Model No.	Max. Duct Temperature
AF1, AF1-S	300° (149° C)
AF2	300°F (149° C)
AF3, AF3-D, AFE-1	275°F (135° C)

The tables below show the velocity of air flow required to actuate McDonnell & Miller AF1, AF1-S, AF2, AF3 and AF3-D air flow switches, in feet per minute (FPM).

AIR FLOW VELOCITY IN FPM (Approximate) REQUIRED TO ACTIVATE SWITCHES

Based on standard air 0.075 pounds per cubic foot. Tabulated flow rates are averages and may vary ± 10% for downward flow.

FLOW means that the switch will close circuits C-N.O. and open circuits C-N.C. when flow rate is increased to the FPM shown.

NO FLOW means that the switch will open circuits C-N.O. and close circuits C-N.C. when flow rate is decreased to the FPM shown.

HORIZONTAL DUCT (PREFERRED INSTALLATION)					VERTICAL DUCT — UPWARD FLOW				
Model No.	Air Flow (FPM)				Maximum Air Flow				
	Min. (Factory) Adjustment		Maximum Adjustment						
	Flow	No Flow	Flow	No Flow					
AF-1, AF1-S	480 (700)*	185 (220)*	1385 (2230)*	1160 (1820)*	2500				
AF-2	380	210	1250	1000	2000				
AF-3	235	175	1445	1365	1200				
AF3-D	295	220	1445	1000	1200				

*Standard paddle trimmed to 5 1/4" long.

AFE-1

The versatile AFE-1 meets the need of many applications where the detection of flow or loss of Air Flow must be accomplished in hazardous atmospheres under less-than-ideal conditions.

The AFE-1 responds to medium air flow velocities and switch sensitivity may be readily adjusted to specific rates of flow.

CAUTION

To prevent ignition of hazardous atmosphere, break circuit before removing cover of control, and keep cover tightly closed when in operation.

Designed for industrial applications where a hazardous environment atmosphere is present, the AFE-1 Air Flow Switch is hazardous duty listed by Underwriters for use in Class 1 Group C & D, and Class 2 Group E, F & G atmospheres.

HORIZONTAL DUCTS

	INSTALLED IN HORIZONTAL DUCT	TOP MOUNT (PREFERRED)	SIDE MOUNT
Factory or Minimum Adjustment	FLOW	350 FPM	400 FPM
	NO FLOW	100 FPM	100 FPM
Maximum Adjustment	FLOW	1900 FPM	1900 FPM
	NO FLOW	500 FPM	900 FPM

INSTALL ONLY IN HORIZONTAL DUCTS
DO NOT MOUNT IN VERTICAL DUCT!

Flow rates are averages which may vary ± 10% from tabulated values. Minimum Duct Size—8" high or 8" wide depending on switch installation.

Maximum air flow velocity-2000 F.P.M.

MECHANICAL INSTALLATION

NOTE: Due to the heavier construction of the AFE-1 switch enclosure, the ducts at the mounting site may require reinforcing.

HORIZONTAL DUCT—Side Mounting

1. Using level, draw 12" line along duct in direction of air flow. Be sure line is true horizontal. (See Diagram A).
2. Mark the four mounting holes and paddle opening.
3. Drill holes and cut out paddle opening.
4. Mount control with air flow direction in duct corresponding to arrows on control. Use gasket and four screws packed with switch.

HORIZONTAL DUCT—BOTTOM OR TOP MOUNTING

1. DRAW 6" line across duct at 90° angle to air flow direction.
2. Using level check duct for horizontal. If duct is not true horizontal it will be necessary to place shims between duct and control to make sure control will be mounted true horizontal. (Diagram B shows how to determine shim size).
3. Mark the four holes and 2 7/8" circular paddle opening.
4. Drill holes and cut out paddle opening.
5. Mount control with air flow direction in duct corresponding to arrows on control using shims if necessary. Use gasket and four screws packed with switch.

VERTICAL DUCT

Follow "Horizontal Duct—Bottom or Top Mounting" steps.

Diagram B - Place end of level at high point of duct approx. 1 7/8" from line drawn in (1). Measure approximately 3 1/2" from end and estimate size of shim required to mount control on true horizontal.

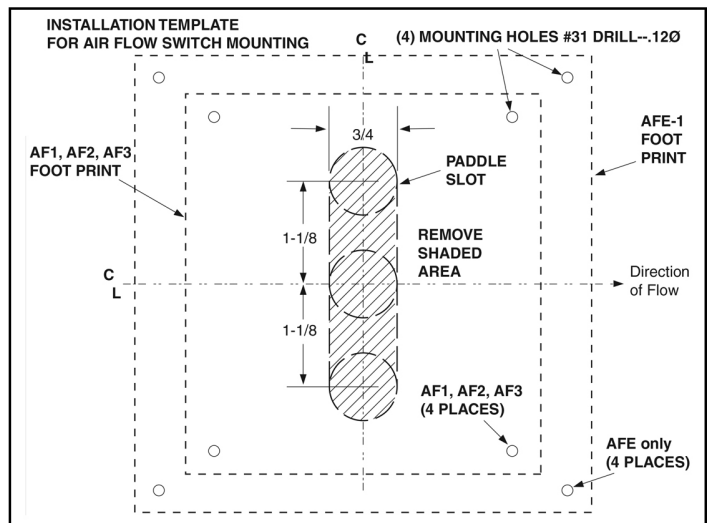
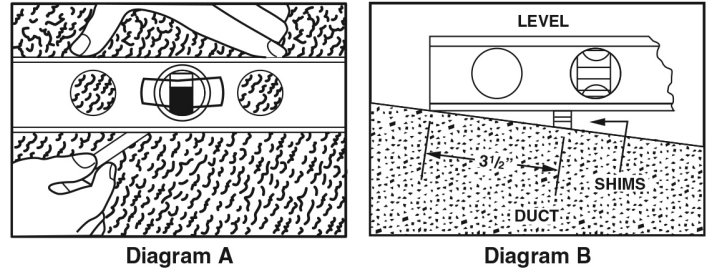

ELECTRICAL INSTALLATION

Switch Operating Schematics

NOTE: DOUBLE SWITCH MODELS CAN PERFORM ANY TWO FUNCTIONS

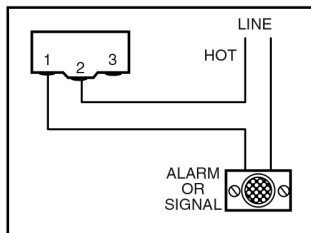

1. Used to sound alarm or light signal when flow occurs.

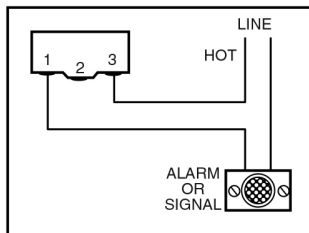

2. Used to sound alarm or light signal when no-flow occurs.

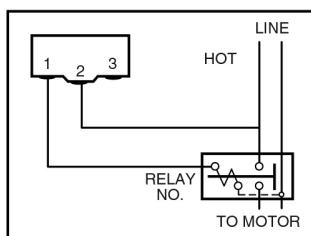

3. Used with single phase circuit-starts motor when flow occurs, stops motor when no-flow occurs.

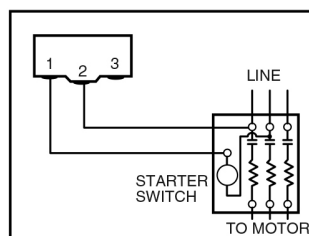

4. Used with three phase circuit-starts motor when flow occurs, stops motor when no-flow occurs.

ON AFE-1

ELECTRICAL

Using approved hazardous duty fittings, conduit, and cable, connect and electrically wire the control in accordance with the wiring instructions.

IMPORTANT

Use wire suitable for at least 90°C operation.

IMPORTANT

After installation and/or adjustment, cycle air flow at least three or four times to insure the control functions properly. It is good operating practice to test the control at least once a year to make sure the control is functioning properly.

ADJUSTMENT

The adjustment screw is factory set for a minimum flow velocities. To obtain higher velocities before the switch is actuated, turn adjusting screw in clockwise direction.

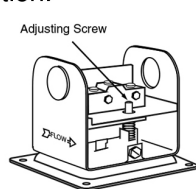

AF3 MODEL

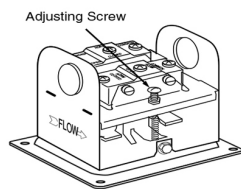

DOUBLE SWITCH MODELS
AF3-D MODEL

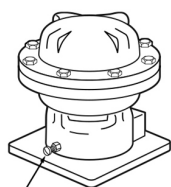

Adjusting Screw & Locknut
(at flange base)

AFE-1 MODEL

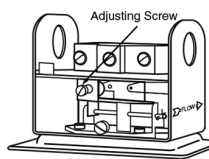

SINGLE SWITCH MODELS
AF1, AF1-S & AF2 MODELS

MAINTENANCE SCHEDULE:

- Inspect annually. Turbulent or high flow velocity conditions may require more frequent inspection and/or replacement.
- Replace flow switch every five years or 100,000 cycles, whichever occurs first.

COMMERCIAL WARRANTY

Warranty. For goods sold to commercial buyers, Seller warrants the goods sold to Buyer hereunder (with the exception of membranes, seals, gaskets, elastomer materials, coatings and other "wear parts" or consumables all of which are not warranted except as otherwise provided in the quotation or sales form) will be (i) be built in accordance with the specifications referred to in the quotation or sales form, if such specifications are expressly made a part of this Agreement, and (ii) free from defects in material and workmanship for a period of one (1) year from the date of installation or two (2) years from the date of manufacture, whichever shall occur first, unless a longer period is specified in the product documentation (the "Warranty").

Except as otherwise required by law, Seller shall, at its option and at no cost to Buyer, either repair or replace any product which fails to conform with the Warranty provided Buyer gives written notice to Seller of any defects in material or workmanship within ten (10) days of the date when any defects or non-conformance are first manifest. Under either repair or replacement option, Seller shall not be obligated to remove or pay for the removal of the defective product or install or pay for the installation of the replaced or repaired product and Buyer shall be responsible for all other costs, including, but not limited to, service costs, shipping fees and expenses. Seller shall have sole discretion as to the method or means of repair or replacement. Buyer's failure to comply with Seller's repair or replacement directions shall terminate Seller's obligations under this Warranty and render the Warranty void. Any parts repaired or replaced under the Warranty are warranted only for the balance of the warranty period on the parts that were repaired or replaced. Seller shall have no warranty obligations to Buyer with respect to any product or parts of a product that have been: (a) repaired by third parties other than Seller or without Seller's written approval; (b) subject to misuse, misapplication, neglect, alteration, accident, or physical damage; (c) used in a manner contrary to Seller's instructions for installation, operation and maintenance; (d) damaged from ordinary wear and tear, corrosion, or chemical attack; (e) damaged due to abnormal conditions, vibration, failure to properly prime, or operation without flow; (f) damaged due to a defective power supply or improper electrical protection; or (g) damaged resulting from the use of accessory equipment not sold or approved by Seller. In any case of products not manufactured by Seller, there is no warranty from Seller; however, Seller will extend to Buyer any warranty received from Seller's supplier of such products.

THE FOREGOING WARRANTY IS EXCLUSIVE AND IN LIEU OF ANY AND ALL OTHER EXPRESS OR IMPLIED WARRANTIES, GUARANTEES, CONDITIONS OR TERMS OF WHATEVER NATURE RELATING TO THE GOODS PROVIDED HEREUNDER, INCLUDING WITHOUT LIMITATION ANY IMPLIED WARRANTIES OF MERCHANTABILITY AND FITNESS FOR A PARTICULAR PURPOSE, WHICH ARE HEREBY EXPRESSLY DISCLAIMED AND EXCLUDED. EXCEPT AS OTHERWISE REQUIRED BY LAW, BUYER'S EXCLUSIVE REMEDY AND SELLER'S AGGREGATE LIABILITY FOR BREACH OF ANY OF THE FOREGOING WARRANTIES ARE LIMITED TO REPAIRING OR REPLACING THE PRODUCT AND SHALL IN ALL CASES BE LIMITED TO THE AMOUNT PAID BY THE BUYER FOR THE DEFECTIVE PRODUCT. IN NO EVENT SHALL SELLER BE LIABLE FOR ANY OTHER FORM OF DAMAGES, WHETHER DIRECT, INDIRECT, LIQUIDATED, INCIDENTAL, CONSEQUENTIAL, PUNITIVE, EXEMPLARY OR SPECIAL DAMAGES, INCLUDING BUT NOT LIMITED TO LOSS OF PROFIT, LOSS OF ANTICIPATED SAVINGS OR REVENUE, LOSS OF INCOME, LOSS OF BUSINESS, LOSS OF PRODUCTION, LOSS OF OPPORTUNITY OR LOSS OF REPUTATION.

LIMITED CONSUMER WARRANTY

Warranty. For goods sold for personal, family or household purposes, Seller warrants the goods purchased hereunder (with the exception of membranes, seals, gaskets, elastomer materials, coatings and other "wear parts" or consumables all of which are not warranted except as otherwise provided in the quotation or sales form) will be free from defects in material and workmanship for a period of one (1) year from the date of installation or two (2) years from the product date code, whichever shall occur first, unless a longer period is provided by law or is specified in the product documentation (the "Warranty").

Except as otherwise required by law, Seller shall, at its option and at no cost to Buyer, either repair or replace any product which fails to conform with the Warranty provided Buyer gives written notice to Seller of any defects in material or workmanship within ten (10) days of the date when any defects or non-conformance are first manifest. Under either repair or replacement option, Seller shall not be obligated to remove or pay for the removal of the defective product or install or pay for the installation of the replaced or repaired product and Buyer shall be responsible for all other costs, including, but not limited to, service costs, shipping fees and expenses. Seller shall have sole discretion as to the method or means of repair or replacement. Buyer's failure to comply with Seller's repair or replacement directions shall terminate Seller's obligations under this Warranty and render this Warranty void. Any parts repaired or replaced under the Warranty are warranted only for the balance of the warranty period on the parts that were repaired or replaced. The Warranty is conditioned on Buyer giving written notice to Seller of any defects in material or workmanship of warranted goods within ten (10) days of the date when any defects are first manifest.

Seller shall have no warranty obligations to Buyer with respect to any product or parts of a product that have been: (a) repaired by third parties other than Seller or without Seller's written approval; (b) subject to misuse, misapplication, neglect, alteration, accident, or physical damage; (c) used in a manner contrary to Seller's instructions for installation, operation and maintenance; (d) damaged from ordinary wear and tear, corrosion, or chemical attack; (e) damaged due to abnormal conditions, vibration, failure to properly prime, or operation without flow; (f) damaged due to a defective power supply or improper electrical protection; or (g) damaged resulting from the use of accessory equipment not sold or approved by Seller. In any case of products not manufactured by Seller, there is no warranty from Seller; however, Seller will extend to Buyer any warranty received from Seller's supplier of such products.

THE FOREGOING WARRANTY IS PROVIDED IN PLACE OF ALL OTHER EXPRESS WARRANTIES. ALL IMPLIED WARRANTIES, INCLUDING BUT NOT LIMITED TO THE IMPLIED WARRANTIES OF MERCHANTABILITY AND FITNESS FOR A PARTICULAR PURPOSE, ARE LIMITED TO ONE (1) YEAR FROM THE DATE OF INSTALLATION OR TWO (2) YEARS FROM THE PRODUCT DATE CODE, WHICHEVER SHALL OCCUR FIRST. EXCEPT AS OTHERWISE REQUIRED BY LAW, BUYER'S EXCLUSIVE REMEDY AND SELLER'S AGGREGATE LIABILITY FOR BREACH OF ANY OF THE FOREGOING WARRANTIES ARE LIMITED TO REPAIRING OR REPLACING THE PRODUCT AND SHALL IN ALL CASES BE LIMITED TO THE AMOUNT PAID BY THE BUYER FOR THE DEFECTIVE PRODUCT. IN NO EVENT SHALL SELLER BE LIABLE FOR ANY OTHER FORM OF DAMAGES, WHETHER DIRECT, INDIRECT, LIQUIDATED, INCIDENTAL, CONSEQUENTIAL, PUNITIVE, EXEMPLARY OR SPECIAL DAMAGES, INCLUDING BUT NOT LIMITED TO LOSS OF PROFIT, LOSS OF ANTICIPATED SAVINGS OR REVENUE, LOSS OF INCOME, LOSS OF BUSINESS, LOSS OF PRODUCTION, LOSS OF OPPORTUNITY OR LOSS OF REPUTATION.

Some states do not allow limitations on how long an implied warranty lasts, so the above limitation may not apply to you. Some states do not allow the exclusion or limitation of incidental or consequential damages, so the above exclusions may not apply to you. This warranty gives you specific legal rights, and you may also have other rights which may vary from state to state.

To make a warranty claim, check first with the dealer from whom you purchased the product or call +1-847-966-3700 for the name and location of the nearest dealer providing warranty service.

xylem
Let's Solve Water

Xylem Inc.
8200 N. Austin Avenue
Morton Grove, Illinois 60053
Phone: (847) 966-3700
Fax: (847) 965-8379
www.xylem.com/mcdonnellmiller

McDonnell & Miller is a trademark of Xylem Inc. or one of its subsidiaries.
© 2019 Xylem Inc. MM-605H March 2019 Part No. 246707



Troubleshooting

Problem 1. Flow Switch Does Not Operate

Solution:

- Make sure power has been turned on to device and flow switch.
- Verify that flow rate is high enough for flow switch to activate. Measure flow rate and match with velocities shown in flow rate chart.
- Check to see if paddle moves freely. Some system disassembly may be required.

Problem 2. Flow Switch Operates Erratically

Solution:

- Adjustment screw may have been turned below original factory setpoint. Verify that flow rate is high enough for flow switch to activate. Measure flow rate and match with velocities shown in flow rate chart.
- Check to see if paddle moves freely. Some system disassembly may be required.

Problem 3. Flow Switch Does Not Deactivate

Solution:

- Check to see if paddle moves freely. Some system disassembly may be required.
- Measure flow rate and match with velocities shown in flow rate chart. Flow switch must prove flow before it can indicate no flow.