

Series FS4-3

Series FS4-3 General Purpose Liquid Flow Switch

OPERATION

This control is an independently mounted water flow sensing device that makes or breaks an electrical circuit when flow stops or starts.



WARNING



- Before using product, read and understand instructions.
- Save these instructions for future reference.



- All work must be performed by qualified personnel trained in the proper application, installation, and maintenance of plumbing, steam and electrical equipment and/or systems in accordance with all applicable codes and ordinances.
- To prevent electrical shock, turn off the electrical power before making electrical connections.



- To prevent an electrical fire or equipment damage, electrical wiring insulation must have a rating of 167°F (75°C) if the liquid's temperature exceeds 180°F (82°C).
- To prevent electrocution, when the electrical power is connected to the flow switch, do not touch the terminals.
- Make sure flow switch electrical cover is secured before turning on electric power.
- Liquid media containing debris or other particulates should be filtered to avoid damage to or obstruction of the Flow Switch paddle arm assembly, which could cause the Flow Switch to malfunction.
- **This product can expose you to chemicals including Lead, which is known to the State of California to cause cancer and birth defects or other reproductive harm. For more information go to: www.P65Warnings.ca.gov.**

Failure to follow this warning could cause property damage, personal injury or death.

SPECIFICATIONS

Maximum Liquid Pressure: 160 psi (11.3 kg/cm²)

Liquid Temperature Range (T_L): 32 - 300°F (0 - 149°C)

Ambient Temperature Range (T_s): 32 - 120°F (0 - 49°C)

Electrical Enclosure Rating: Nema Type 1 (IP 21)

Maximum Velocity: 10ft/sec (3M/sec)

Pipe Connection Thread Size: - 1" NPT - *All models except "J"*
 - 1" BSPT - *"J" models*

FLOW RATES

Flow rates required to activate the flow switch are shown in chart below. These values were calculated using clean water in a horizontal pipe.

Pipe Size NPT in. (mm)	Settings	Mode of Operation		Max. Flow Rate gpm (lpm) w/o Paddle Damage
		Flow gpm (lpm)	No Flow gpm (lpm)	
1 (25)	Factory or Minimum	6 (22.7)	3.6 (13.6)	27 (102)
	Maximum	10.2 (38.6)	9.2 (34.8)	
1¼ (32)	Factory or Minimum	9.8 (37.1)	5.6 (21.2)	47 (178)
	Maximum	16.8 (63.6)	15 (56.8)	
1½ (40)	Factory or Minimum	12.7 (48.1)	7 (26.5)	63 (239)
	Maximum	23 (87.1)	19.5 (73.8)	
2 (50)	Factory or Minimum	18.8 (71.2)	9.4 (35.6)	105 (398)
	Maximum	32.8 (124.1)	24 (90.8)	
2½ (65)	Factory or Minimum	24.3 (92)	11.6 (43.9)	149 (565)
	Maximum	42.4 (160.5)	37.5 (141.9)	
3 (80)	Factory or Minimum	30 (113.6)	12 (45.4)	230 (872)
	Maximum	52.1 (197.2)	46.1 (174.5)	
4 (100)	Factory or Minimum	39.7 (150.3)	19.8 (74.9)	397 (1505)
	Maximum	73.5 (278.2)	64.2 (242)	
5 (125)	Factory or Minimum	58.7 (222.2)	29.3 (110.9)	654 (2479)
	Maximum	115 (435.3)	92 (348.2)	
6 (150)	Factory or Minimum	79.2 (300)	39.6 (150)	900 (3411)
	Maximum	166 (628.3)	123 (465.6)	

Values are ± 10%

ELECTRICAL RATINGS

Voltage	Motor Switch Rating (Amperes)		Pilot Duty
	Full Load	Locked Rotor	
120 VAC	7.4	44.4	125 VA at 120 or 240 VAC 50 or 60 cycles
240 VAC	3.7	22.2	

Settings will vary when used to sense flow of other fluids or if located in a vertical pipe.

NOTE: THIS PRODUCT IS NOT INTENDED FOR USE IN POTABLE WATER APPLICATIONS.

NOTE: DO NOT USE LIQUID FLOW SWITCHES ON SYSTEMS WITH FLOW VELOCITY GREATER THAN 10 FEET PER SECOND (3 METERS PER SECOND).

INSTALLATION –

STEP 1 - Paddle Sizing

Determine the correct paddle length for your installation from the chart below.

Pipe Size		Paddle (Standard Length)		Trim to Length	
in.	(mm)	in.	(mm)	in.	(mm)
1	(25)	1	(25)	N/A	
1 1/4	(32)	2	(51)	1 1/4	(32)
1 1/2	(40)	2	(51)	1 1/2	(38)
2	(50)	2	(51)	1 5/8	(41)
2 1/2	(65)	3	(76)	2 1/4	(57)
3	(80)	3	(76)	2 5/8	(67)
4	(100)	6	(152)	3 5/8	(92)
6	(150)	6	(152)	5 5/8	(143)
8+	(200+)	6	(152)	N/A	

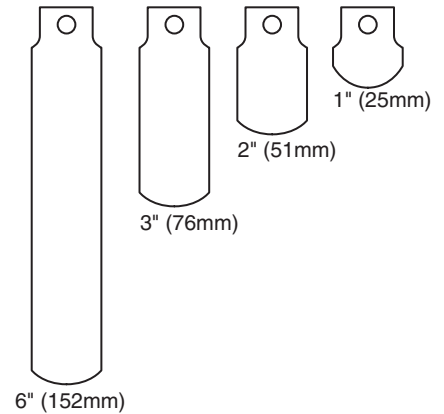

NOTE:

- All models (except FS4-3RP) include 4 paddles.
- FS4-3RP includes 1" and 6" paddles only.

a. If the paddle must be trimmed, measure the paddle from the center of the large hole (A) to the length required. Using non-serrated tin snips, trim the end (B) on a curve just like the paddle was originally cut.

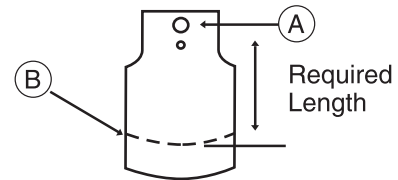

b. If the flow rate in the pipe exceeds the maximum adjustment on the Flow Switch use the following formula to change the paddle length.

$$\text{Paddle Length} = \frac{K}{\text{Flow Rate (GPM)}}$$

NOTE: If trimming the paddle for a no-flow action make sure there is enough flow to activate switch.

Series FS4-3 “K” Factor

Pipe Size NPT in. (mm)	Flow Maximum Adjustment	No-Flow Maximum Adjustment
2 (50)	69.2	50.3
3 (80)	162.5	143.5
4 (100)	276.0	241.0
5 (125)	550.0	440.0
6 (150)	977.0	728.0

STEP 2 - Determine the Location of the Flow Switch

- The flow switch **should be located in a horizontal section of pipe** where there is a straight horizontal run of at least 5 pipe diameters on each side of the flow switch. The flow switch may be installed in a vertical pipe if the flow is in the upward direction.
- The flow switch **must be installed in the upright position** as shown with arrow mark on side of casting in the same direction as fluid will flow.
- Some system conditions that require more than 5 pipe diameters are high viscosity fluid and high fluid velocity.
- The flow switch must be installed in the pump suction piping when spring-loaded check valves and/or other close coupled accessories are installed in the pump discharge piping.

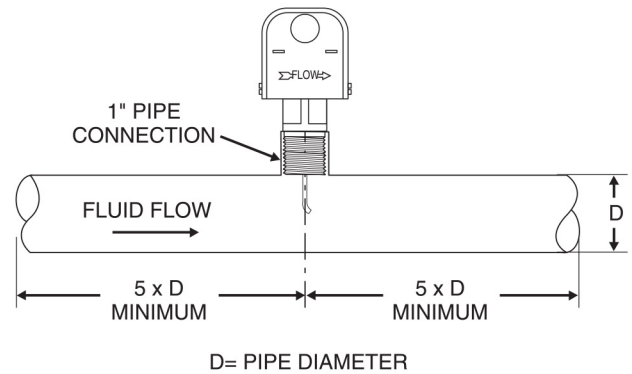

- a. The flow switch must be installed in the pipe using a threaded tee connection or welded fitting of minimum length such as a half coupling. Use a

face or hex bushing to reduce the tee outlet to 1" (25mm) pipe thread if a reduced tee outlet thread size fitting is not available.

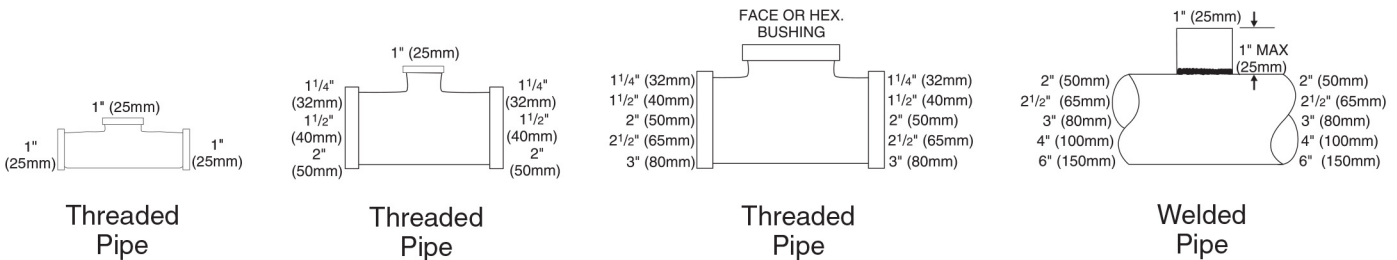

- b. When installing in brazed/soldered copper pipe, size the threaded adapter to ensure the paddle arm extends into the main run of the pipe

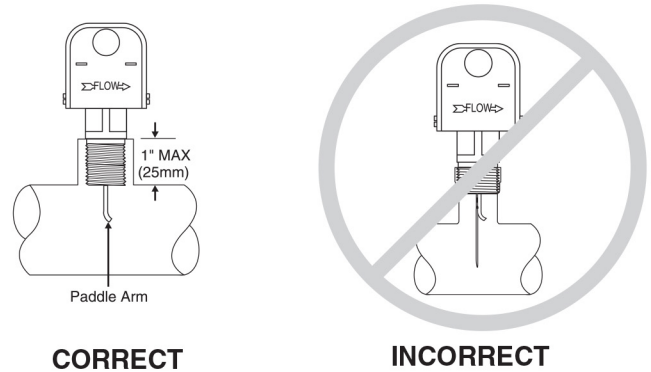

STEP 3 - Connecting the Flow Switch to Pipe

- a. Insert the 8/32 x 1/4" flathead screw through washer and paddle. Attach screw to opposite side of the paddle arm's curve and tighten to a torque of approximately 12-16 lb•in (1.36-1.81 N•m).

NOTE:

- If two paddles are being installed, they must be stacked one on top of the other with the longer paddle first in line to the flow.
- Follow the same procedure while replacing the paddle arms.

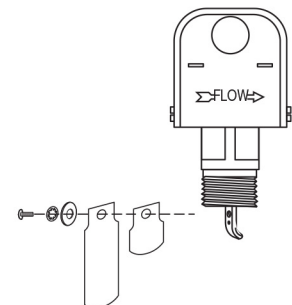

- b. Apply pipe sealing compound or PTFE tape to the flow switch pipe threads.

NOTE: Do not apply sealant to first threads as this switch is grounded (earthed) via the pipe mounting.

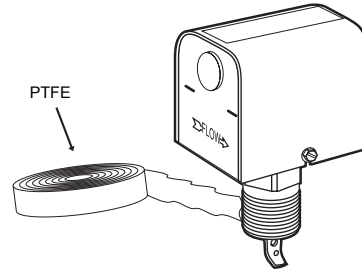

- c. Insert the flow switch into the pipe tee. Turn the flow switch two (2) or three (3) revolutions clockwise until tight. Do not put excessive force on cover when turning.

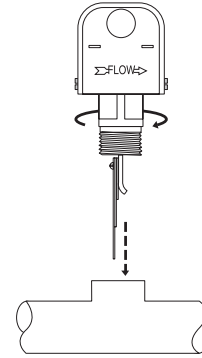

- d. Place a 1 3/8" open end wrench on flow switch body to tighten to final position. Final position is with arrow on housing aligned in the same direction as liquid flow.

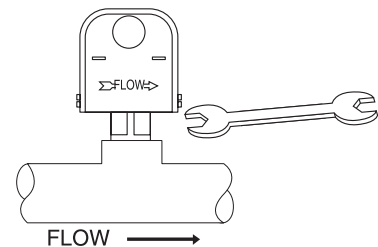

STEP 4 - Electrical Installation

⚠ WARNING



- To prevent electrical shock, turn off the electrical power before making electrical connections.
 - To prevent an electrical fire or equipment damage, electrical wiring insulation must have a rating of 167°F (75°C) if the liquid's temperature exceeds 180°F (82°C).
 - To prevent electrocution, when the electrical power is connected to the flow switch, do not touch the terminals.
 - Make sure flow switch electrical cover is secured before turning on electric power.
- Failure to follow this warning could cause property damage, personal injury or death.

a. Cover Removal and Installation Procedure

- Using a flathead screwdriver, loosen but do not remove the two cover screws and remove the cover (A).
- Place the cover on the flow switch sliding the slots behind the two loose cover screws. Push the cover down into the flow switch and using a flat blade screwdriver, tighten the cover screws to a torque of 10 lb•in (1.13 N•m).

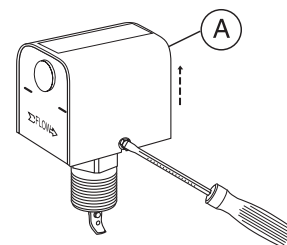

b. Electrical Conduit Connection

- Connect electric conduit to flow switch electrical enclosure.
- Follow accepted electrical practices when installing fittings and making connections.
- Refer to and follow local codes and standards when selecting the types of electrical fittings and conduit to connect to flow switch.

c. Determine which switch action is required for the flow switch.

- “Flow” means that the switch will close circuit C.-N.O. and open circuit C.-N.C. when flow rate is increased above setpoint of flow switch.
- “No Flow” means that the switch will open circuit C.-N.O. and close circuit C.-N.C. when flow rate is decreased below setpoint of flow switch.

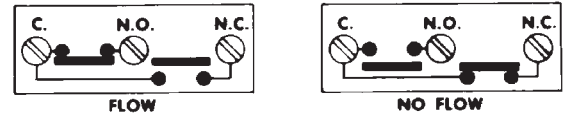

d. Based upon the mode of operation (“Flow” or “No-Flow”) required, complete the appropriate steps to connect wires to flow switch. Use a Phillip’s head screwdriver to loosen and tighten switch terminal screws when attaching wires.

For “Flow” Mode of Operation (Fig. 1)

If the flow switch will be used to actuate a signal, alarm or other device when **flow** occurs, connect the wire from that device to the “N.O.” contact. Connect the “Hot” power supply wire to “C” terminal.

For “No Flow” Mode of Operation (Fig. 2)

If the flow switch will be used to actuate a signal, alarm or other device when **no flow** occurs, connect the wire from that device to the “N.C.” contact. Connect the “Hot” power supply wire to “C” terminal.

NOTE: Repeat above to connect wires to second switch on “D” model flow switches.

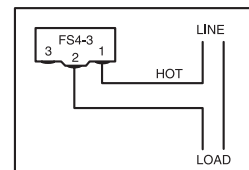
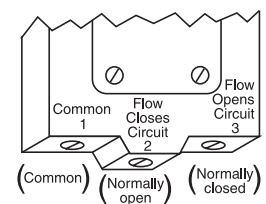
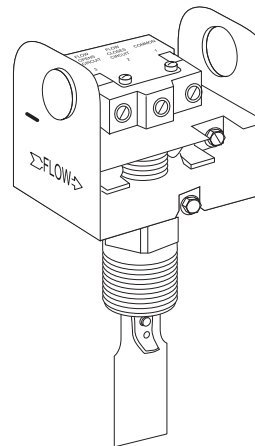

Fig. 1

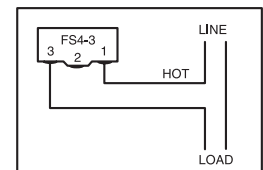
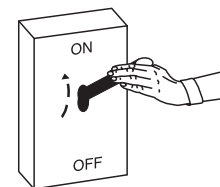

Fig. 2

STEP 5 - Testing

- Place cover on flow switch and turn on power. Initiate fluid flow through the system. Observe the device being activated by the flow switch to determine if device is operating as required.
- Turn off fluid flow to determine if device is operating as required.
- Repeat initiating and turning off fluid flow several times to test flow switch and device for proper operation.
 - If operating as required, put system into service.
 - If not operating as required, Flow Switch may need to be adjusted.



STEP 6 - Adjustment

Adjustment is necessary only if required flow/no-flow setpoints are **above** factory set minimum.

- a. Turn off power. Remove switch cover.
- b. Turn the adjusting screw clockwise to increase setpoint.

IMPORTANT: Do not attempt to lower flow switch setpoint from original factory minimum setting. Lowering (turning adjusting screw counterclockwise) the setpoint from original factory setting may cause erratic flow switch operation.

- c. Place cover on the flow switch and turn on power.
- d. Test the operation of the flow switch after each adjustment.

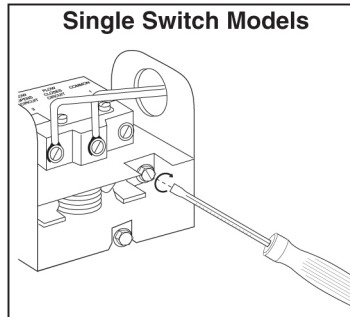

OR

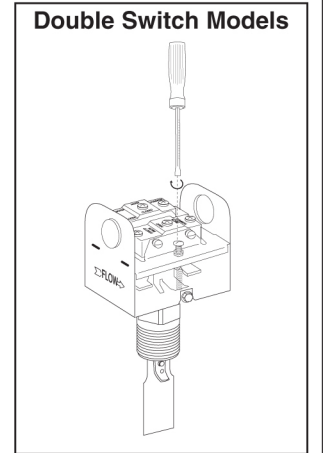

MAINTENANCE

SCHEDULE:

- Inspect paddle annually. Turbulent or high flow velocity conditions may require more frequent inspection and/or replacement.
- Replace paddle if damaged or showing signs of wear.
- Replace flow switch every 5 years or 100,000 cycles, whichever occurs first.

TROUBLESHOOTING

Problem:

1. Flow Switch Does Not Operate

Solution:

- a. Make sure power has been turned on to device and flow switch.
- b. Verify that flow rate is high enough for flow switch to activate. Measure flow rate and match with velocities shown in flow rate chart.
- c. Check to see if paddle moves freely. Some system piping disassembly may be required.

2. Flow Switch Operates Erratically

Solution:

- a. Flow switch may be located in an area of high turbulence causing paddles to flutter.
- b. Adjustment screw may have been turned below original factory setpoint. Verify that flow rate is high enough for flow switch to activate. Measure flow rate and match with velocities shown in flow rate chart.
- c. Check to see if paddle moves freely. Some system piping disassembly may be required.

3. Flow Switch Does Not Deactivate

Solution:

- a. Check to see if paddle moves freely. Some system piping disassembly may be required.
- b. Measure flow rate and match with velocities shown in flow rate chart. Flow switch must prove flow before it can indicate no flow.

COMMERCIAL WARRANTY

Warranty. For goods sold to commercial buyers, Seller warrants the goods sold to Buyer hereunder (with the exception of membranes, seals, gaskets, elastomer materials, coatings and other "wear parts" or consumables all of which are not warranted except as otherwise provided in the quotation or sales form) will be (i) be built in accordance with the specifications referred to in the quotation or sales form, if such specifications are expressly made a part of this Agreement, and (ii) free from defects in material and workmanship for a period of one (1) year from the date of installation or two (2) years from the date of manufacture, whichever shall occur first, unless a longer period is specified in the product documentation (the "Warranty").

Except as otherwise required by law, Seller shall, at its option and at no cost to Buyer, either repair or replace any product which fails to conform with the Warranty provided Buyer gives written notice to Seller of any defects in material or workmanship within ten (10) days of the date when any defects or non-conformance are first manifest. Under either repair or replacement option, Seller shall not be obligated to remove or pay for the removal of the defective product or install or pay for the installation of the replaced or repaired product and Buyer shall be responsible for all other costs, including, but not limited to, service costs, shipping fees and expenses. Seller shall have sole discretion as to the method or means of repair or replacement. Buyer's failure to comply with Seller's repair or replacement directions shall terminate Seller's obligations under this Warranty and render the Warranty void. Any parts repaired or replaced under the Warranty are warranted only for the balance of the warranty period on the parts that were repaired or replaced. Seller shall have no warranty obligations to Buyer with respect to any product or parts of a product that have been: (a) repaired by third parties other than Seller or without Seller's written approval; (b) subject to misuse, misapplication, neglect, alteration, accident, or physical damage; (c) used in a manner contrary to Seller's instructions for installation, operation and maintenance; (d) damaged from ordinary wear and tear, corrosion, or chemical attack; (e) damaged due to abnormal conditions, vibration, failure to properly prime, or operation without flow; (f) damaged due to a defective power supply or improper electrical protection; or (g) damaged resulting from the use of accessory equipment not sold or approved by Seller. In any case of products not manufactured by Seller, there is no warranty from Seller; however, Seller will extend to Buyer any warranty received from Seller's supplier of such products.

THE FOREGOING WARRANTY IS EXCLUSIVE AND IN LIEU OF ANY AND ALL OTHER EXPRESS OR IMPLIED WARRANTIES, GUARANTEES, CONDITIONS OR TERMS OF WHATEVER NATURE RELATING TO THE GOODS PROVIDED HEREUNDER, INCLUDING WITHOUT LIMITATION ANY IMPLIED WARRANTIES OF MERCHANTABILITY AND FITNESS FOR A PARTICULAR PURPOSE, WHICH ARE HEREBY EXPRESSLY DISCLAIMED AND EXCLUDED. EXCEPT AS OTHERWISE REQUIRED BY LAW, BUYER'S EXCLUSIVE REMEDY AND SELLER'S AGGREGATE LIABILITY FOR BREACH OF ANY OF THE FOREGOING WARRANTIES ARE LIMITED TO REPAIRING OR REPLACING THE PRODUCT AND SHALL IN ALL CASES BE LIMITED TO THE AMOUNT PAID BY THE BUYER FOR THE DEFECTIVE PRODUCT. IN NO EVENT SHALL SELLER BE LIABLE FOR ANY OTHER FORM OF DAMAGES, WHETHER DIRECT, INDIRECT, LIQUIDATED, INCIDENTAL, CONSEQUENTIAL, PUNITIVE, EXEMPLARY OR SPECIAL DAMAGES, INCLUDING BUT NOT LIMITED TO LOSS OF PROFIT, LOSS OF ANTICIPATED SAVINGS OR REVENUE, LOSS OF INCOME, LOSS OF BUSINESS, LOSS OF PRODUCTION, LOSS OF OPPORTUNITY OR LOSS OF REPUTATION.

LIMITED CONSUMER WARRANTY

Warranty. For goods sold for personal, family or household purposes, Seller warrants the goods purchased hereunder (with the exception of membranes, seals, gaskets, elastomer materials, coatings and other "wear parts" or consumables all of which are not warranted except as otherwise provided in the quotation or sales form) will be free from defects in material and workmanship for a period of one (1) year from the date of installation or two (2) years from the product date code, whichever shall occur first, unless a longer period is provided by law or is specified in the product documentation (the "Warranty").

Except as otherwise required by law, Seller shall, at its option and at no cost to Buyer, either repair or replace any product which fails to conform with the Warranty provided Buyer gives written notice to Seller of any defects in material or workmanship within ten (10) days of the date when any defects or non-conformance are first manifest. Under either repair or replacement option, Seller shall not be obligated to remove or pay for the removal of the defective product or install or pay for the installation of the replaced or repaired product and Buyer shall be responsible for all other costs, including, but not limited to, service costs, shipping fees and expenses. Seller shall have sole discretion as to the method or means of repair or replacement. Buyer's failure to comply with Seller's repair or replacement directions shall terminate Seller's obligations under this Warranty and render this Warranty void. Any parts repaired or replaced under the Warranty are warranted only for the balance of the warranty period on the parts that were repaired or replaced. The Warranty is conditioned on Buyer giving written notice to Seller of any defects in material or workmanship of warranted goods within ten (10) days of the date when any defects are first manifest.

Seller shall have no warranty obligations to Buyer with respect to any product or parts of a product that have been: (a) repaired by third parties other than Seller or without Seller's written approval; (b) subject to misuse, misapplication, neglect, alteration, accident, or physical damage; (c) used in a manner contrary to Seller's instructions for installation, operation and maintenance; (d) damaged from ordinary wear and tear, corrosion, or chemical attack; (e) damaged due to abnormal conditions, vibration, failure to properly prime, or operation without flow; (f) damaged due to a defective power supply or improper electrical protection; or (g) damaged resulting from the use of accessory equipment not sold or approved by Seller. In any case of products not manufactured by Seller, there is no warranty from Seller; however, Seller will extend to Buyer any warranty received from Seller's supplier of such products.

THE FOREGOING WARRANTY IS PROVIDED IN PLACE OF ALL OTHER EXPRESS WARRANTIES. ALL IMPLIED WARRANTIES, INCLUDING BUT NOT LIMITED TO THE IMPLIED WARRANTIES OF MERCHANTABILITY AND FITNESS FOR A PARTICULAR PURPOSE, ARE LIMITED TO ONE (1) YEAR FROM THE DATE OF INSTALLATION OR TWO (2) YEARS FROM THE PRODUCT DATE CODE, WHICHEVER SHALL OCCUR FIRST. EXCEPT AS OTHERWISE REQUIRED BY LAW, BUYER'S EXCLUSIVE REMEDY AND SELLER'S AGGREGATE LIABILITY FOR BREACH OF ANY OF THE FOREGOING WARRANTIES ARE LIMITED TO REPAIRING OR REPLACING THE PRODUCT AND SHALL IN ALL CASES BE LIMITED TO THE AMOUNT PAID BY THE BUYER FOR THE DEFECTIVE PRODUCT. IN NO EVENT SHALL SELLER BE LIABLE FOR ANY OTHER FORM OF DAMAGES, WHETHER DIRECT, INDIRECT, LIQUIDATED, INCIDENTAL, CONSEQUENTIAL, PUNITIVE, EXEMPLARY OR SPECIAL DAMAGES, INCLUDING BUT NOT LIMITED TO LOSS OF PROFIT, LOSS OF ANTICIPATED SAVINGS OR REVENUE, LOSS OF INCOME, LOSS OF BUSINESS, LOSS OF PRODUCTION, LOSS OF OPPORTUNITY OR LOSS OF REPUTATION.

Some states do not allow limitations on how long an implied warranty lasts, so the above limitation may not apply to you. Some states do not allow the exclusion or limitation of incidental or consequential damages, so the above exclusions may not apply to you. This warranty gives you specific legal rights, and you may also have other rights which may vary from state to state.

To make a warranty claim, check first with the dealer from whom you purchased the product or call +1-847-966-3700 for the name and location of the nearest dealer providing warranty service.

xylem
Let's Solve Water

Xylem Inc.
8200 N. Austin Avenue
Morton Grove, Illinois 60053
Phone: (847) 966-3700
Fax: (847) 965-8379
www.xylem.com/mcdonnellmiller

McDonnell & Miller is a trademark of Xylem Inc. or one of its subsidiaries.
© 2021 Xylem Inc. MM-601M January 2021 Part No. 246796

