

# MRCH-1P52N

## OPPEN CABINET HANDLE

meir®



### FEATURES

- Refer to the Meir website for warranty terms & conditions. Stainless steel material.
- See website for the matching Meir colour options.
- Smooth brushed finish.
- Resilient PVD coating.
- Suitable for cabinet wall thickness of 16mm to 22mm and 26mm to 32mm.

### CARE

- Do not install using any form of acetone silicones.
- Do not apply physical items (such as tools) directly to the product.
- Never use house-hold abrasive cleaners.
- Clean using a mild washing soap solution.
- Check for any product defects before installation.
- Refer to the Installation Manual for correct installation.

### SPECIFICATIONS

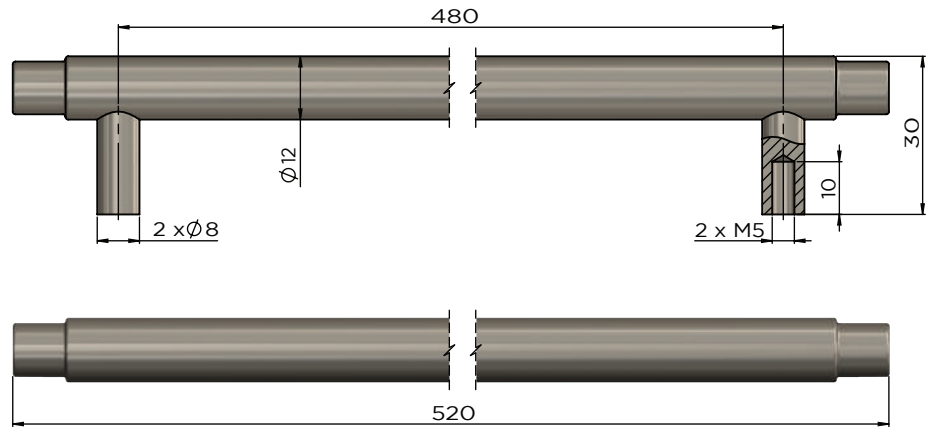

### EXPLODED VIEW

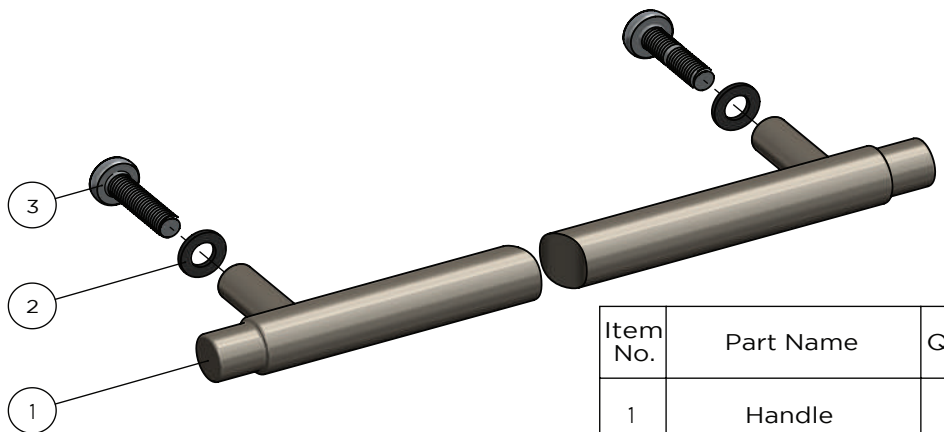

Item No.	Part Name	Qty.
1	Handle	1
2	Washer	2
3	Screw	2