

# ➤ Instructions

## Thule Yepp 2 Maxi Rack Mount 120212XX

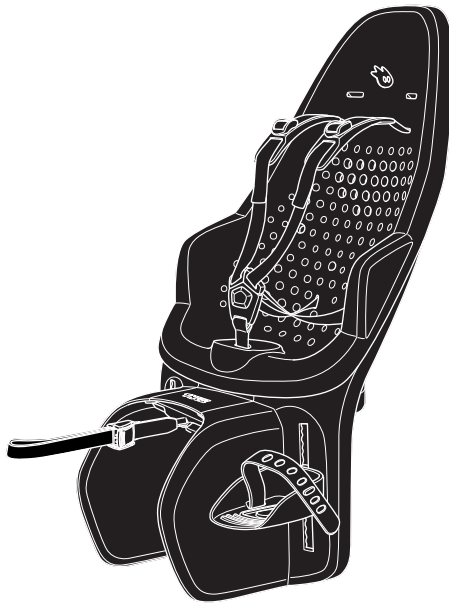

<b>EN</b>	Rear mounted child bike seat	<b>CS</b>	Zadní dětská cyklosedačka
<b>FR</b>	Siège vélo enfant arrière	<b>HU</b>	Kerékpáros hátsó gyereklülés
<b>ES</b>	Asiento para niños en la parte trasera de la bicicleta	<b>RO</b>	Scaun spate de copii pentru bicicletă
<b>DE</b>	Fahrradkindersitz	<b>SK</b>	Zadná dětská cyklosedačka
<b>NL</b>	Fietszitie voor achterop	<b>SL</b>	Zadnji otroški kolesarski sedež
<b>PT</b>	Assento infantil traseiro para bicicleta	<b>BG</b>	Задна детска седалка за велосипед
<b>IT</b>	Seggiolino da bicicletta posteriore	<b>HR</b>	Dječja sjedalica za bicikl koja se postavlja straga
<b>SV</b>	Cykelbarnstol för bakre cykelmontering	<b>EL</b>	Πίσω παιδικό κάθισμα ποδηλάτου
<b>DK</b>	Bagmonteret cykelstol	<b>TR</b>	Arkaya Bağlanan Çocuk Bisiklet Koltuğu
<b>NO</b>	Bakmontert barnesykkelse	<b>MT</b>	Sedil tar-Rota għat-Tfal li Jitpoġġa Wara
<b>FI</b>	Lastenistuin polkupyörän taakse		מושב אופניים אחורי לילד <b>HE</b>
<b>IS</b>	Barnasæti aftan á reiðhjól		مقعد الدراجة الخلفي للطفل <b>AR</b>
<b>ET</b>	Jalgratta tagumine lasteiste	<b>ZH (CN)</b>	后置式儿童自行车座椅
<b>LV</b>	Velosipēda aizmugurējais bērna sēdekļis	<b>ZH (TW)</b>	後座式自行車兒童座椅
<b>LT</b>	Galinė vaikiška dviračio kėdutė	<b>JA</b>	サイクル後部用チャイルドシート
<b>RU</b>	Заднее детское велосипедное сиденье	<b>KO</b>	후면 어린이 자전거 시트
<b>UK</b>	Заднє дитяче велосипедне крісло	<b>TH</b>	เก้าอี้เด็กสำหรับซ้อนท้ายจักรยาน
<b>PL</b>	Fotelik rowerowy do przewożenia dziecka montowany z tyłu	<b>MS</b>	Tempat Duduk Basikal Kanak-kanak Belakang

**EN 14344:2022**

**ASTM F1625-00**



- EN** Please read the following instructions carefully and keep them for future reference.
- DE** Bitte die folgenden Anleitung aufmerksam durch und bewahren Sie sie zum späteren Nachschlagen auf.
- FR** Veuillez lire attentivement les instructions suivantes et les conserver pour référence future.
- NL** Dient u zorgvuldig de volgende instructies te lezen en deze als toekomstig naslagwerk te bewaren.
- IT** Leggi le seguenti istruzioni attentamente e conservale per consultazioni future.
- ES** Lea las instrucciones siguientes atentamente y guárdelas para consultas posteriores.
- PT** Leia cuidadosamente as instruções a seguir e guarde-as para referência futura.
- SV** Vi ber dig läsa följande instruktioner noggrant och därefter behålla dem för framtida bruk.
- DK** Skal du læse følgende anvisninger grundigt igennem og gemme dem til fremtidig reference.
- NO** Bør du lese disse instruksjonene nøye. Ta vare på dem i tilfelle du får bruk for dem senere.
- FI** Lue seuraavat ohjeet huolellisesti. Pidä ohjeet tallessa.
- IS** Lestu þessar leiðbeiningar vandlega áður en þú og geymdu þær til síðari nota.
- ET** kasutuselevõttu lugege järgmised juhised hoolikalt läbi ja hoidke need alles.
- LV** lūdzu, izlasiet uzmanīgi tālāk sniegtos norādījumus un saglabājiet tos turpmākai izmantošanai.
- LT** atidžiai perskaitykite toliau pateiktas instrukcijas ir jų neišmeskite, kad galėtumėte peržiūrėti ateityje.
- PL** należy dokładnie przeczytać następujące instrukcje i zachować je do wykorzystania w przyszłości.
- RU** внимательно изучите представленные ниже инструкции и сохраните их для дальнейшего использования.
- UK** ознайомтеся з нижченаведеними інструкціями й зберігайте їх для довідки в майбутньому.
- BG** прочетете внимателно следните инструкции и ги запазете за бъдещи справки.
- CS** si pečlivě přečtete následující pokyny a uložte si je, abyste se k nim mohli kdykoli vrátit.
- SK** si pozorne prečítajte nasledujúce pokyny a uložte si ich, aby ste sa k nim mohli kedykoľvek vrátiť.
- SL** skrbno preberite navodila v nadaljevanju in jih shranite.
- HR** pažljivo pročitajte sljedeće upute i sačuvajte ih za buduću uporabu.
- RO** citiți cu atenție următoarele instrucțiuni și păstrați-le pentru consultare ulterioară.
- HU** használatbavétele előtt figyelmesen olvassa el az alábbi tudnivalókat, és tartsa azokat később is hozzáférhető helyen
- EL** διαβάστε προσεκτικά τις παρακάτω οδηγίες και φυλάξτε τις για μελλοντική αναφορά.
- TR** kullanmadan önce aşağıdaki talimatları dikkatle okuyun ve gelecekte başvurmak amacıyla saklayın.
- MT** jekk jogħġbok aqra l-istruzzjonijiet li ġejjin bir-reġqa u zommhom għal referenza futura.

קרא את ההוראות להלן בקפידה ושומר עליהן לעיון במועד מאוחר יותר. **HE**  
 يرجى قراءة التعليمات التالية بعناية والاحتفاظ بها للرجوع إليها في المستقبل. **AR**

**ZH (CN)** 请仔细阅读以下说明，并保留该说明以供日后参考。

**ZH (TW)** 請詳閱以下說明，並妥善保管以便未來參考使用。

**JA** をご利用になる前に、以下の手順を最後までお読みいただき、今後も参照できるように保管してください。

**KO** 을 사용하기 전에 다음 지침을 잘 읽고 나중에 참고할 수 있도록 보관해 주십시오.

**TH** โปรดอ่านคำแนะนำต่อไปนี้อย่างละเอียดและเก็บไว้เพื่อใช้อ้างอิงในอนาคต

**MS** sila baca arahan berikut dengan teliti dan simpan arahan ini untuk rujukan masa hadapan.

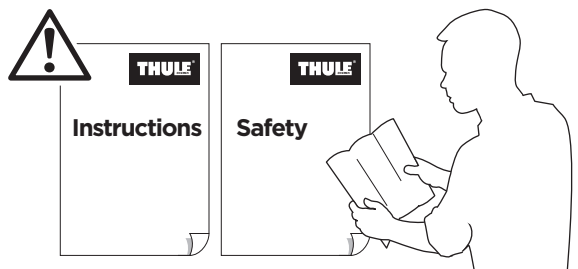

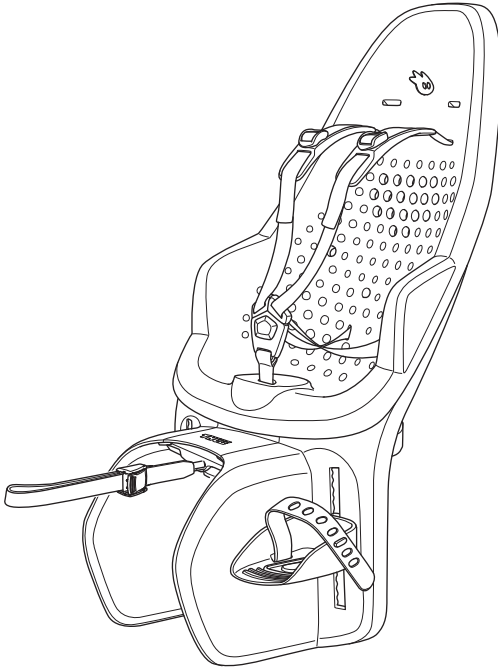

	
9-72 M	9-72 M
9-22 kg	20-40 lbs
110 cm	43.3 inch



Your Key-Number



**0-9 M**



**s.1**



Ø 11 - 28.6 mm  
Ø 0.43 - 1.13 inch

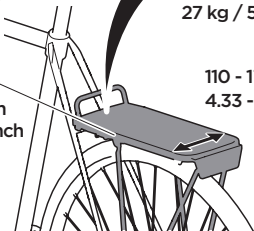

Min. load capacity  
27 kg / 59.5 lbs

110 - 175 mm  
4.33 - 6.90 inch



Ø 11 - 28.6 mm  
Ø 0.43 - 1.13 inch

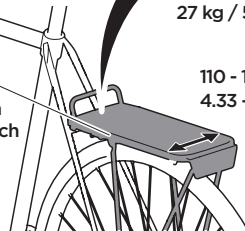

Min. load capacity  
27 kg / 59.5 lbs

110 - 188 mm  
4.33 - 7.40 inch



Max. 25 km/h  
15 mph

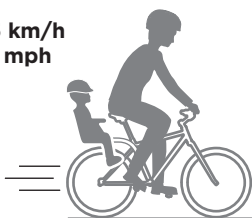

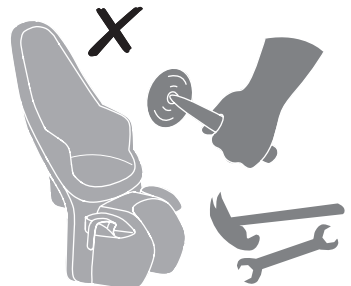
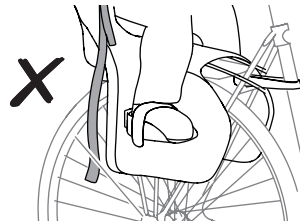
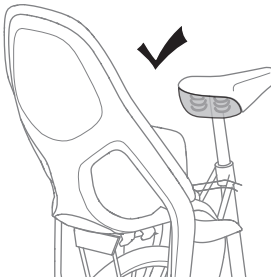
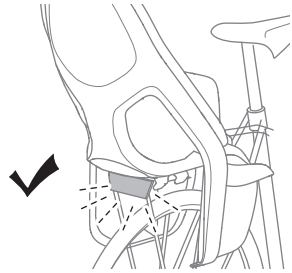
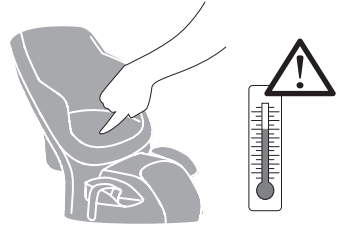

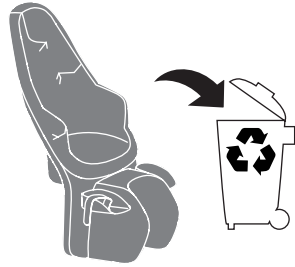
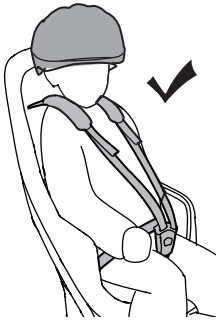
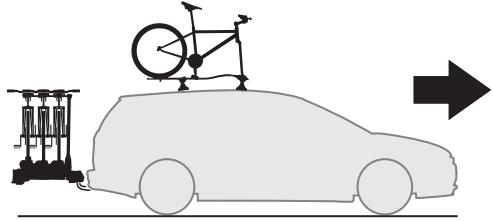
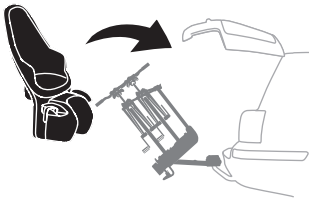

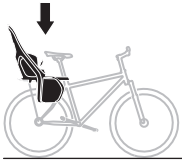

1

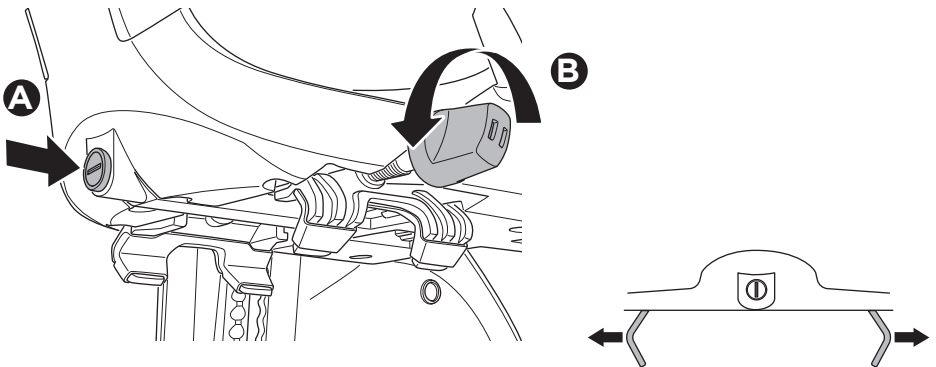
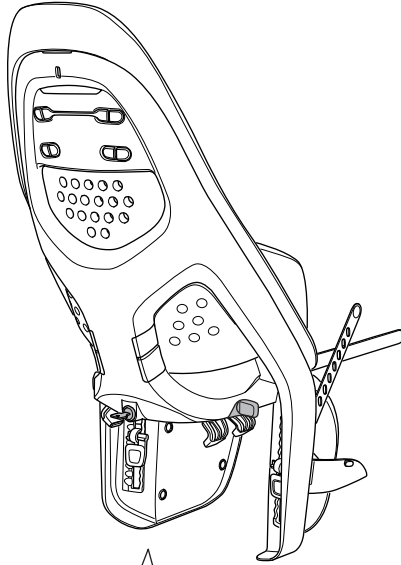



2

A

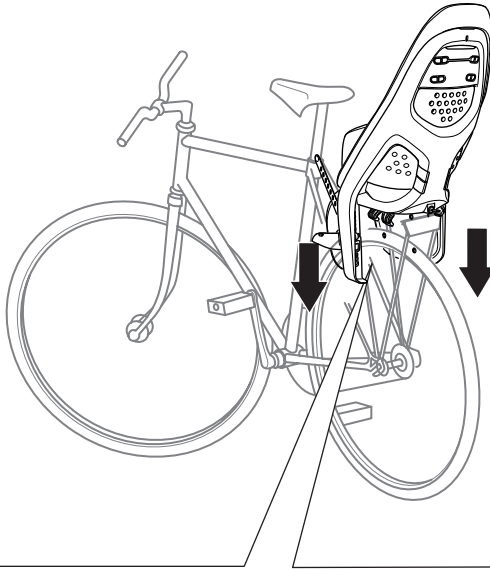

B

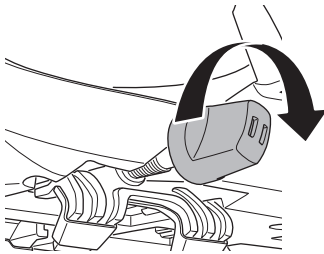

C

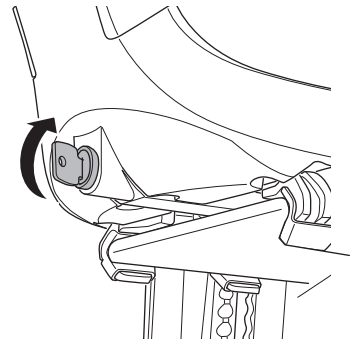

D

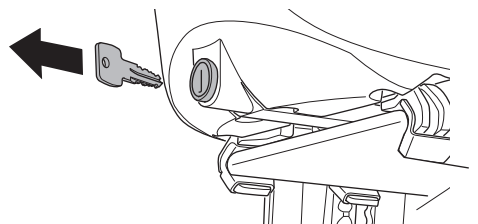
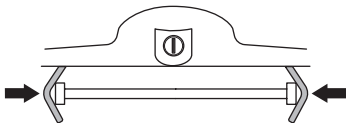

3

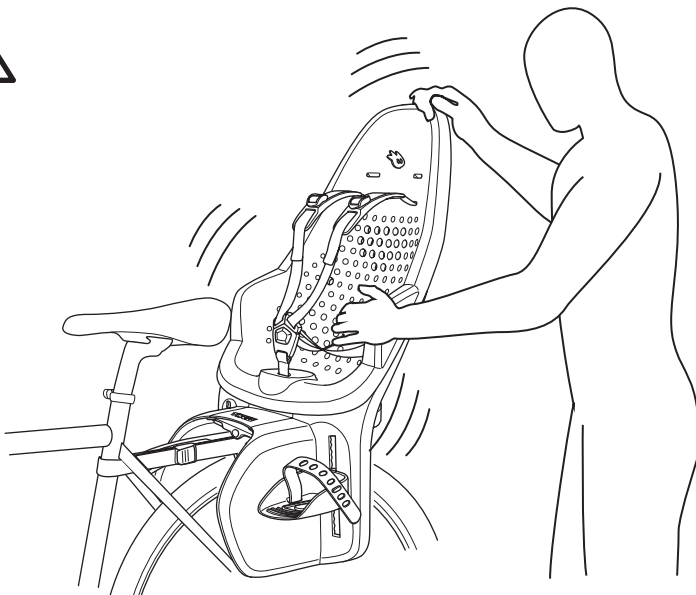
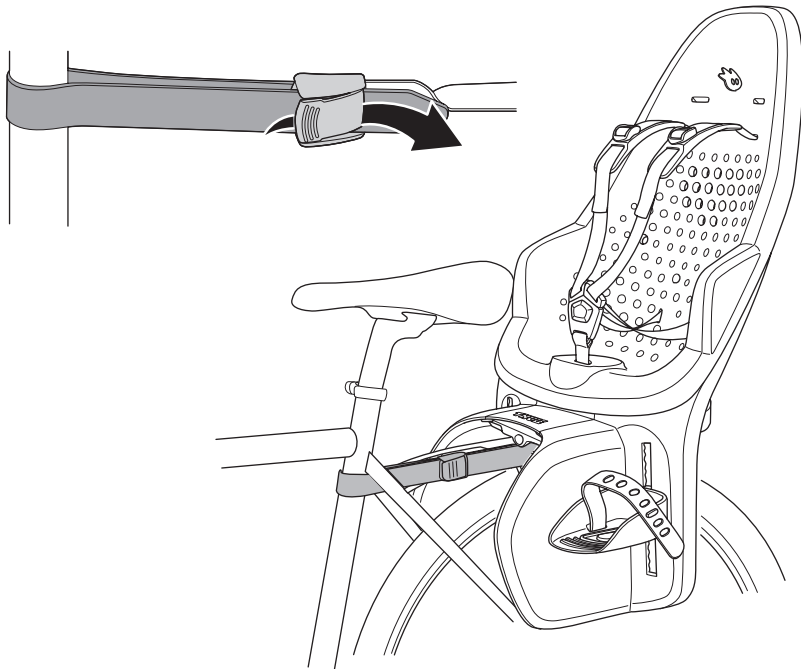



**1**

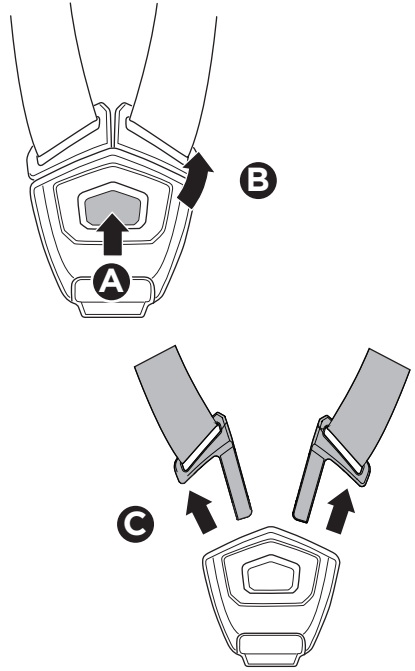
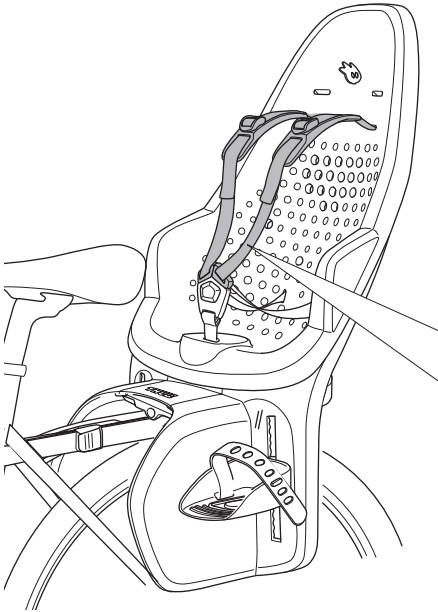

**2**

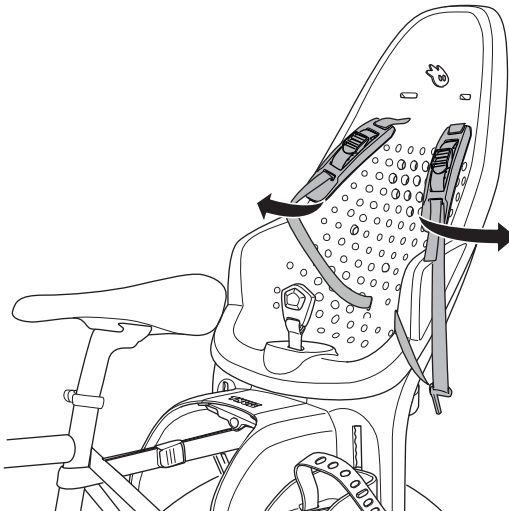

3

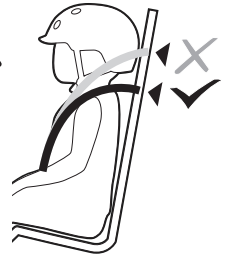
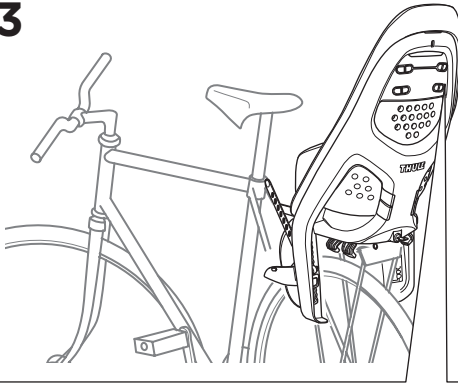

A

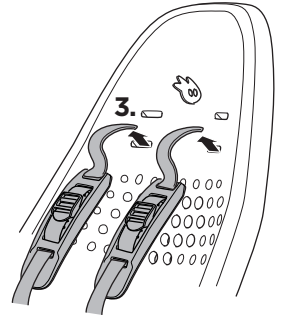
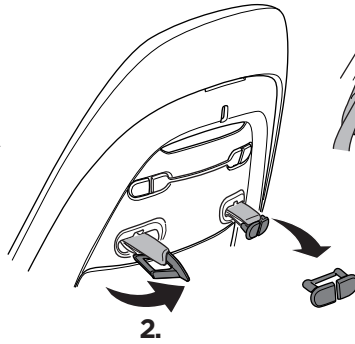
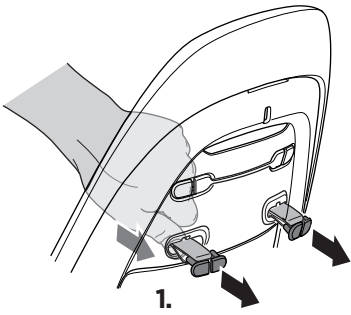

B

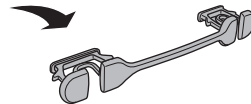
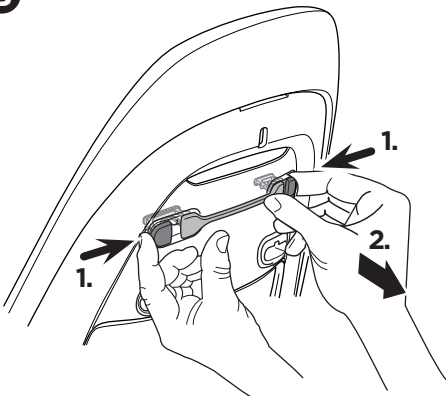

**C**

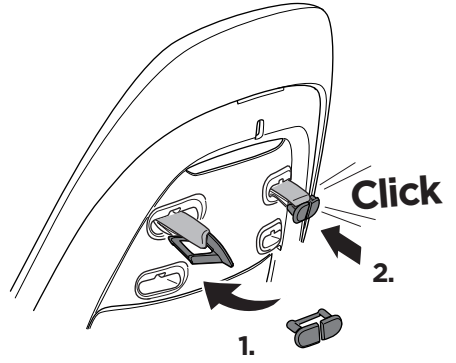
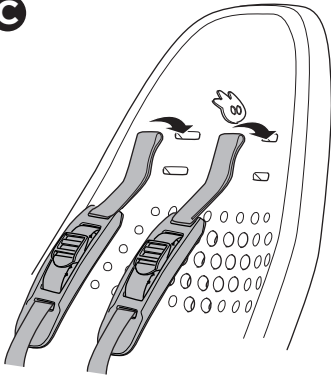

**D**

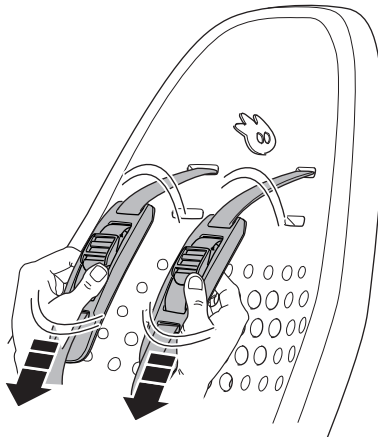
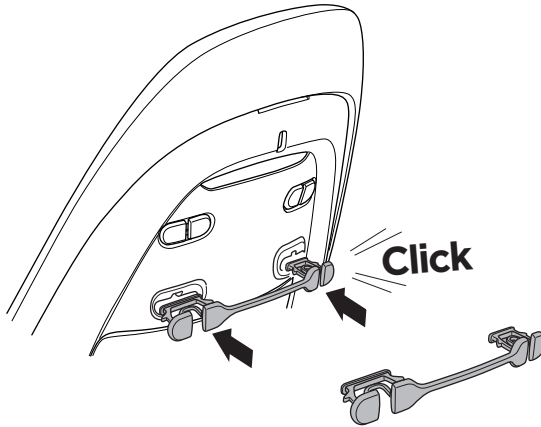

4

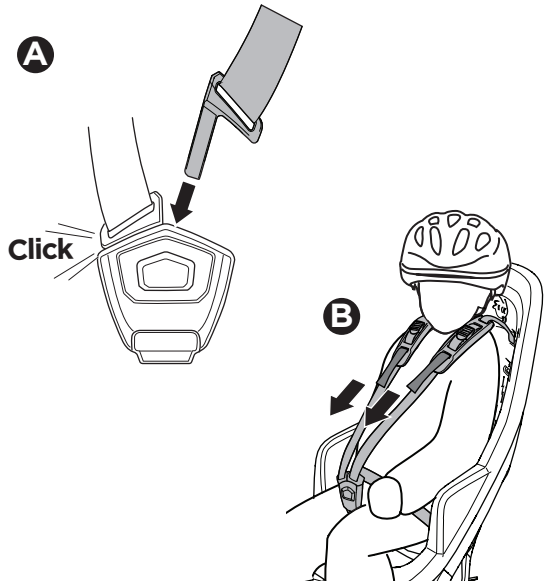
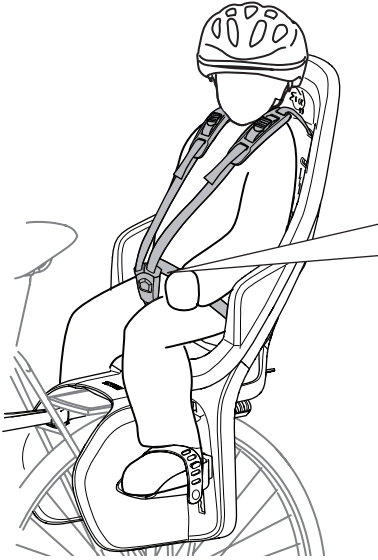

5

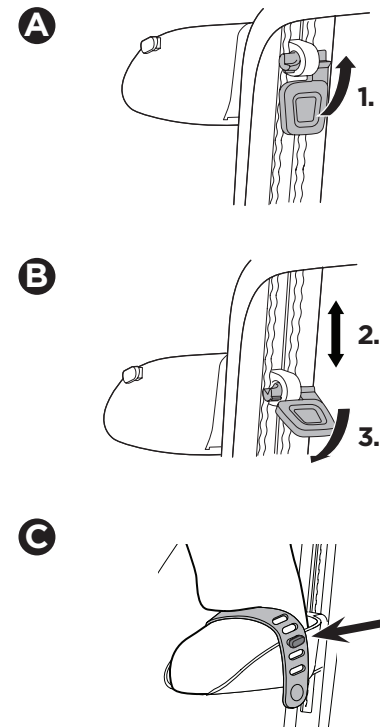
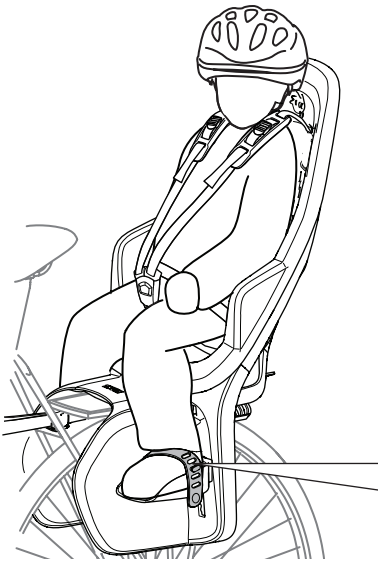

**i**

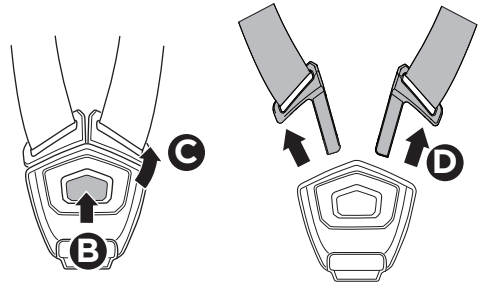
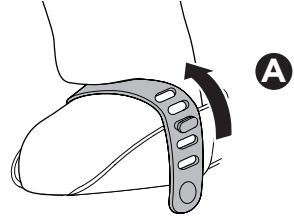
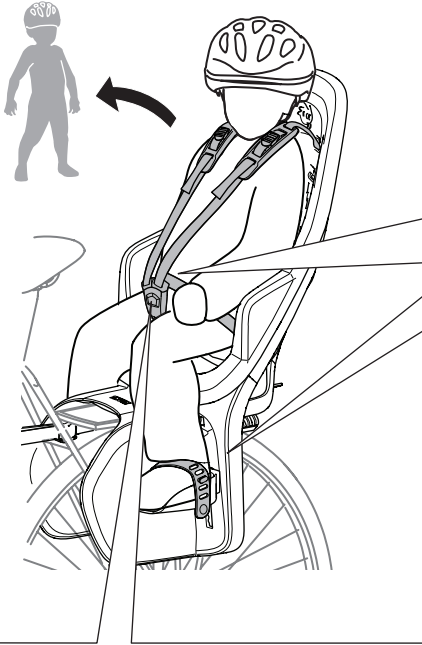

**D**

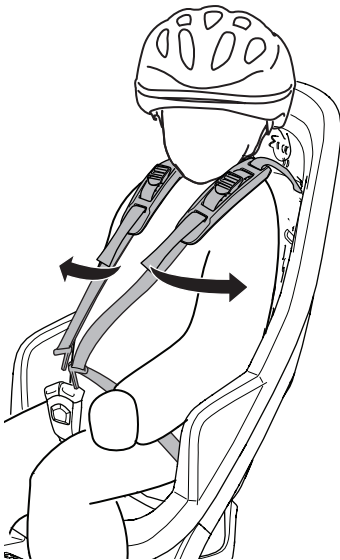

**E**

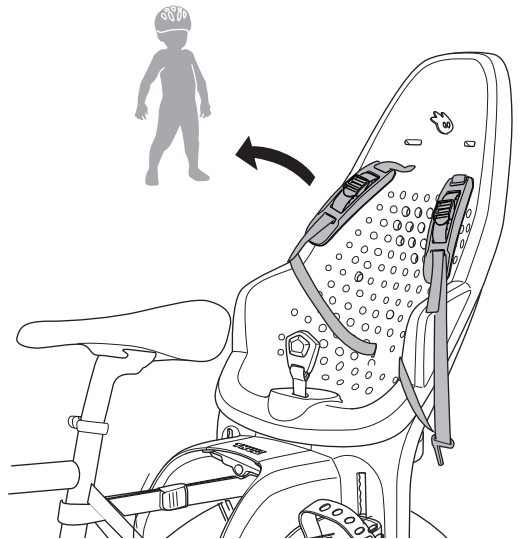

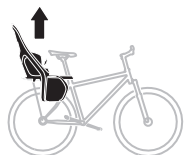

**i**

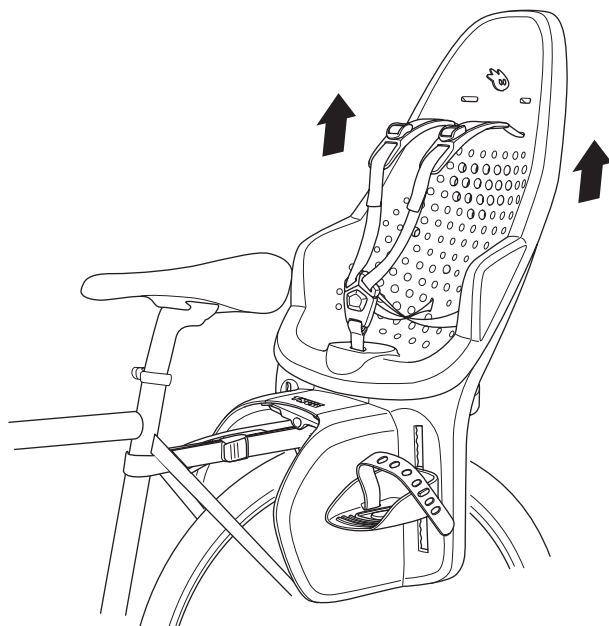

**A**

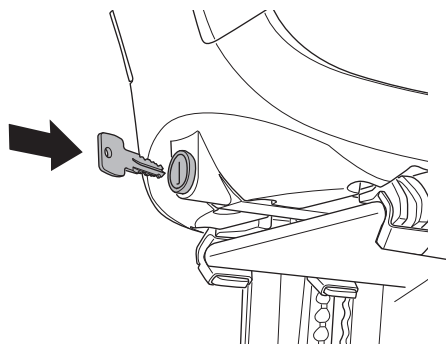

**B**

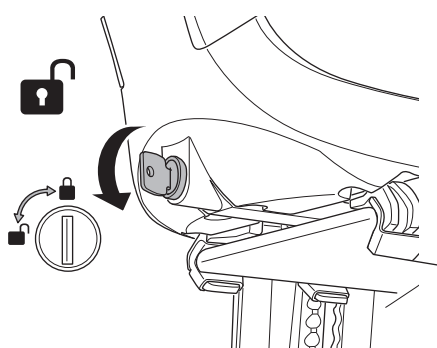



**C**

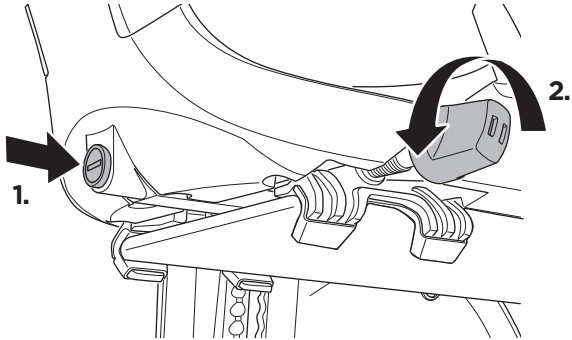

**D**

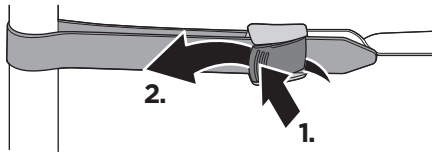

**E**

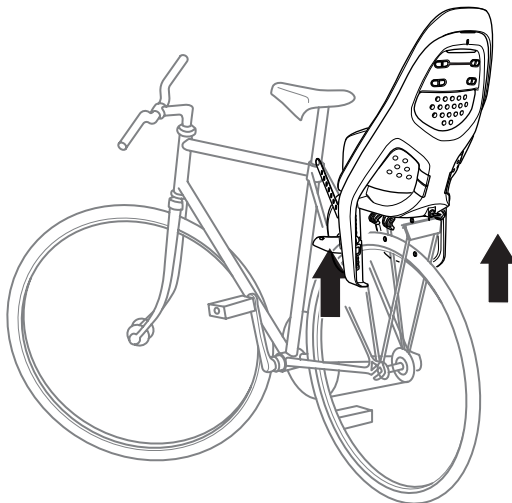

<b>EN</b> Accessories	<b>ET</b> Tarvikud	<b>HR</b> Dodatna oprema	
<b>FR</b> Accessoires	<b>LV</b> Piederumi	<b>EL</b> Αξεσουάρ	
<b>ES</b> Accesorios	<b>LT</b> Priedai	<b>TR</b> Aksesuarlar	
<b>DE</b> Zubehör	<b>RU</b> Аксессуары	<b>MT</b> Aċċessorji	
<b>NL</b> Accessoires	<b>UK</b> Аксесуари		<b>HE</b> אביזרים
<b>PT</b> Acessórios	<b>PL</b> Akcesoria		<b>AR</b> الملحقات
<b>IT</b> Accessori	<b>CS</b> Příslušenství	<b>ZH (CN)</b> 附件	
<b>SV</b> Tillbehör	<b>HU</b> Kiegészítők	<b>ZH (TW)</b> 配件	
<b>DK</b> Tilbehør	<b>RO</b> Accesorii	<b>JA</b> アクセサリー	
<b>NO</b> Tilbehør	<b>SK</b> Príslušenstvo	<b>KO</b> 액세서리	
<b>FI</b> Lisävarusteet	<b>SL</b> Dodatna oprema	<b>TH</b> อุปกรณ์เสริม	
<b>IS</b> Aukabúnaður	<b>BG</b> Аксесоари	<b>MS</b> Aksesori	

### Thule Yepp Raincover

12020972



### Thule Delight

20201516

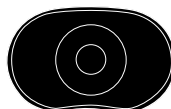

### Thule Yepp Harness Clip

12020920

