

合格证
QC PASS

Godox

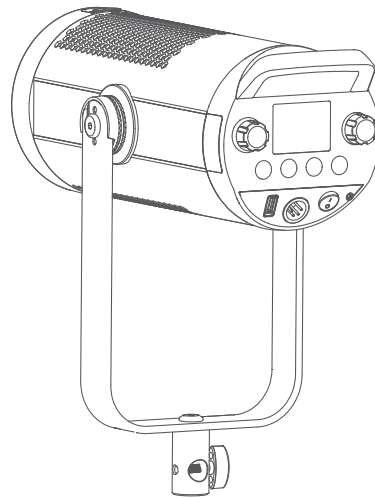

Wechat
Official Account
神牛微信公众号

深圳市神牛摄影器材有限公司

地址: 深圳市宝安区福海街道塘尾社区耀川工业区厂房2栋 电话: 0755-29609320(8062)

传真: 0755-25723423 邮箱: godox@godox.com

GODOX Photo Equipment Co.,Ltd.

Add.: Building 2, Yaochuan Industrial Zone, Tangwei Community, Fuhai Street, Bao'an District,

Shenzhen 518103, China Tel: +86-755-29609320(8062) Fax: +86-755-25723423

E-mail: godox@godox.com

godox.com

Made in China | 705-SZ300R-00



SZ300R

变焦RGB LED摄影灯

Zoom RGB LED Video Light

使用手册

Instruction Manual

重要的安全说明及注意事项

首先作为最基本原则：本产品为专业灯光布景设备，应由专业灯光师使用或在专业人士指导下使用。使用时必须始终遵循基本的安全预防措施，具体安全预防措施如下：

1. 使用前必须阅读并理解产品说明书。
2. 专业灯具，禁止儿童使用。当儿童靠近时，家长或监护人必须密切监督，以免儿童因碰撞灯具或私用灯具造成人身伤害。
3. 本灯具并非普通照明灯具，不可用于普通照明，任何有过眼部损伤或眼部敏感的人群均应避免使用本灯具。
4. 灯具点亮时，必须小心使用，禁止接触高温部件，如LED灯珠，以免造成灼伤。
5. 灯具点亮时，任何情况下均禁止直视灯珠。应该在专业灯光师指导下使用强光，任何情况下避免长时间处于强光环境，如引起眼睛不适，请及时关闭灯具，暂停使用，请及时就医。
6. 倘灯珠损坏或因热变形，应停止使用，并及时联系制造商、服务代理商或合格的维修人员更换灯珠，以免发生意外。
7. 本产品仅适用于-10°C – 40°C工作环境温度及正常湿度环境下使用。
8. 请勿使用损坏的设备或设备配件，待专业维修人员检查维修，确认设备正常方可使用。
9. 在使用过程中，如果本产品由于跌落、受到挤压或遭受强烈冲击而造成外壳破裂的，请勿继续使用，以免因接触到内部电子元件而受到电击伤害。
10. 如需要延长线，请使用额定电流≥该设备额定电流的延长线。如延长线额定电流小于该设备，可能导致过热。
11. 部分产品电源线较长，请合理放置电源线，使其处于安全位置。避免电源线接触过热物体表面、避免放置不当导致拉扯损坏或绊倒现场人员。请使用本厂原装电源线，如使用非本厂电源线导致产品损坏，概不在本厂维修范围内。
12. 在清洁和维修之前，请务必从电源插座上拔下该设备插头。不使用时，禁止拉扯电源线以将设备插头从电源插座中拔出。正常断电，应是用手抓住该设备插头两端，将插头从电源插座中拔出。此设备需连接到接地插座中。
13. 本设备没有防水性能，请让设备保持干燥，请勿将本设备浸入水中或其他液体中。设备需安装在干燥且通风处，避免在雨天、潮湿、多尘或过热环境下使用。请勿将任何物体置于灯具上或使液体流入灯具内部，以免发生意外。
14. 请勿私自拆卸产品，如产品出现故障，须由本公司或授权的维修人员进行检查维修。
15. 存放本设备之前，请确保设备已完全冷却。存放时，将电源线从设备上拔出。设备应放置于设备便携包内或通风干燥处。
16. 请勿将设备放置在酒精、汽油等易燃易爆的溶剂附近。
17. 本厂不推荐的产品附件，请勿使用，以免导致火灾、触电或人身伤害。
18. 清洁本设备时，请勿用湿布擦拭，请用干布，软布擦拭设备污垢。
19. 设备使用前，请注意将保护罩取下。
20. 本产品已通过ROHS, CE和FCC认证，请参考相关国家标准使用和操作。

安全说明依据本厂严格测试制定，设备设计和规格如有变更，恕不另行通知。客户可以上神牛官网查看最新的电子版说明，了解产品最新资讯。

22. 部分产品内置锂电池。此类产品请使用专用的充电器进行充电，并且按正确的操作说明，在规定的电压、温度范围内使用。
23. 部分产品使用电池供电。此类产品请勿使用说明书中未指定的任何电池、电源或附件。请将电池和其他附件置于儿童及婴幼儿无法触及之处。如果儿童或婴幼儿吞下电池或附件，请立刻就医。如果电池漏液、变色、变形、冒烟或发出异味，请立刻将其取出。在取出过程中请小心，以免烫伤。如果继续使用，可能会引起火灾、触电或皮肤烫伤。请勿使用任何变形或改造过的电池。请勿拆卸或改造本产品或电池。请勿加热电池或焊接电池。请勿让电池与火或水接触。请勿让电池受到强烈的外力撞击。请勿将电池的正负端错误插入，或将新旧电池或不同类型的电池混合使用。
24. 一年保修期，消耗品电池、适配器、电源线等配件不在此保修范围内。
25. 经发现，擅自检修设备，将取消一年保修期，维修需要收取相关费用。
26. 对于不规范操作引起的机器故障不在保修范围内。

保存这些说明

前言

感谢您购买神牛产品。

大功率 RGB LED 摄影灯 SZ300R, 输出功率高达 300W, 配备调焦旋钮, 一键调节照射角度 (20°-65°), 通过另购遥控器或使用“Godox light”APP 即可轻松调节 CCT/HSI/RGB/GEL/FX 五大模式参数。如果你还是经常使用控制台的工作者，另购 RJ45 连接线连接 SZ300R RJ45 接口即可使用控制台控制灯具，共有 7 种 DMX 模式。除此之外，SZ300R 支持关闭风扇（静音模式），常适用于要求静音的场景拍摄、人物采访、剧院舞台拍摄、电视台拍摄、摄影棚拍摄、外景拍摄等拍摄场景。

主要特点

- 超广色域色温，支持 2500K-10000K 色温之间按需调节
- 3 种控制方式，支持蓝牙 APP/2.4G 无线 / 灯体控制
- 内置 HSI 模式，36000 种色彩可调，360°全色域随心选择
- 内置 GEL 色片模式，60 种流行色片样式，无耗时自调
- 内置 RGBW 模式，四色混光，获得完美白光及低饱和淡彩光
- 拥有 14 类 FX 场景光效：彩虹循环、激光彩灯、闪光灯、雷闪电、多云、坏灯泡、电视机、蜡烛、火、烟花、爆炸、焊接、警车、SOS
- 配备静音模式（关闭风扇），该模式适用于要求静音的拍摄场景。
- U 型支架为灯具提供 360°旋转角度，使实际布光灵活多变

警告

- ▲ 请保持干燥：请勿用湿手接触产品，亦不可将产品浸入水中或暴露于雨中。
- ▲ 请勿私自拆卸产品，如产品出现故障须由本公司或授权的维修人员进行检查维修。

- ▲ 请勿让儿童接触本产品。
- ▲ 本产品不能防水,在雨天及潮湿环境下请注意防水。
- ▲ 请勿放置在超过 40 摄氏度的高温环境中。
- ▲ 请勿在化学品、可燃性气体或其他特殊物质附近使用 LED 灯。在这些场合下, 请注意相关警告标识。

部件名称

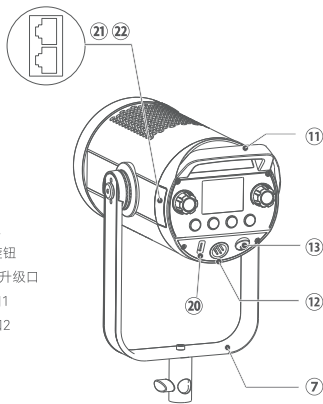
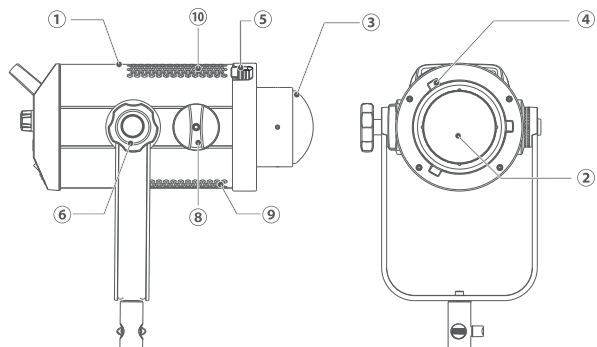

- | | | |
|----------|-----------|-------------|
| 1.灯体 | 9.进风口 | 17.风扇按键 |
| 2.LED 灯珠 | 10.散热口 | 18.DIM 旋钮 |
| 3.玻璃罩 | 11.把手 | 19.FN调节旋钮 |
| 4.保架卡口 | 12.输入接口 | 20.USB固件升级口 |
| 5.卡口推制 | 13.开关拨钮 | 21.RJ45接口1 |
| 6.支架旋钮 | 14.无线按键 | 22.RJ45接口2 |
| 7.U 型支架 | 15.MODE按键 | |
| 8.调焦旋钮 | 16.DMX按键 | |

物料清单

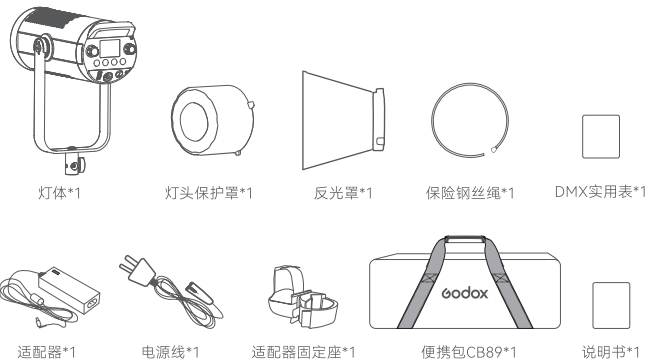

温馨提示: 说明书线图均为示意图, 仅供参考。由于产品不断更新与升级, 产品实物与线图可能存在差异, 请以实物为准。

可另购附件

可搭配本公司摄影附件使用, 以获得最佳拍摄效果和使用体验: 遥控器RC-R9II、柔光箱、反光伞、灯架等。

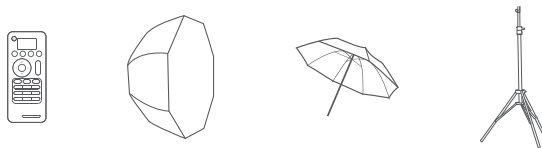

连接DMX控制台

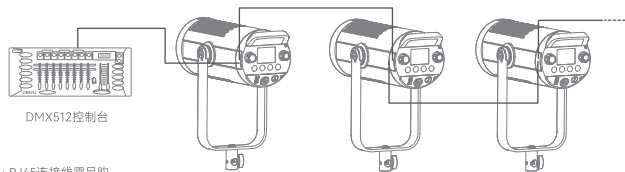

注: RJ45连接线需另购

开关机

通过适配器连接交流电后, 拨动开关按钮即可实现开机/关机。

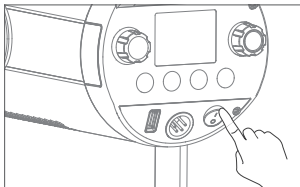

亮度调节

处于CCT/HSI/RGB/GEL/FX模式界面时, 直接旋转DIM旋钮即可调节亮度, 左旋一次减少1个单元值, 右旋一次增加1个单元值, 支持快调, 亮度调节范围为0%~100%。

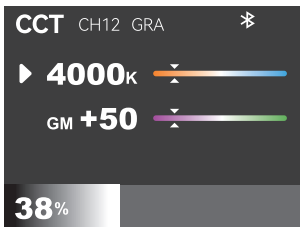

静音模式

短按风扇按键实现开启风扇或关闭风扇, 开启风扇时, 显示屏上方不会出现  图标。关闭风扇时, 显示屏上方出现  图标, 此时灯具处于静音模式。

静音模式时, 处于CCT/GEL/FX模式时, 亮度调节范围为0%~30%。

静音模式时, 处于HSI/RGBW模式时, 亮度调节范围为0%~70%。

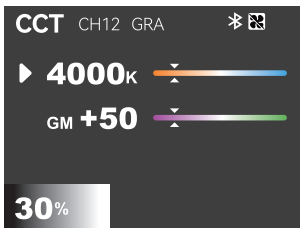

调焦设置

手动旋转调焦旋钮可实现照射角度从20°~65°改变。

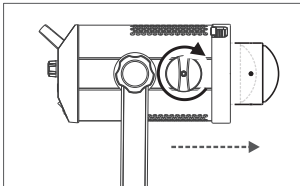

模式选择

短按MODE按键进入模式选择界面, 旋转FN旋钮选中所需模式后, 短按FN旋钮进入模式设置界面。

1. 色温模式

在色温设置界面, 短按FN旋钮可选色温调节或洋红/绿调节, 选好选项后, 左旋一次FN旋钮减少100K色温值或1个洋红/绿值, 右旋一次FN旋钮增加100K色温值或1个洋红/绿值, 支持快调, 色温调节范围为2500~10000K, 洋红/绿调节范围为-50~+50。

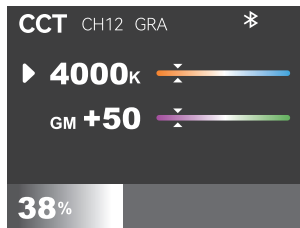

2. HSI彩光模式

在HSI彩光设置界面, 短按FN旋钮可选H(色相)/S(饱和度)。

选好选项后, 左旋一次FN旋钮减少1个色相值或1个饱和度值, 右旋一次FN旋钮增加1个色相值或1个饱和度值, 支持快调, 色相调节范围为0°~360°, 饱和度调节范围为0%~100%。

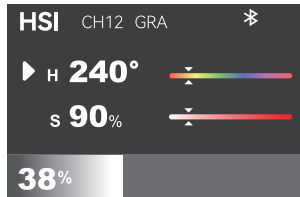

3. RGB模式

在RGB设置界面, 短按FN旋钮可选R(红光)/G(绿光)/B(蓝光)/W(白光)。

选好选项后, 左旋一次FN旋钮减少1个单元值, 右旋一次FN旋钮增加1个单元值, 支持快调, R(红光)/G(绿光)/B(蓝光)/W(白光)调节范围均为0~255。

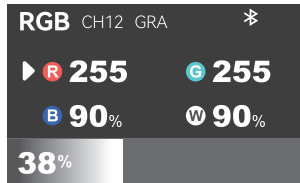

4. GEL色片模式

在GEL设置界面，短按FN旋钮可选色片类型/色片号/色温值。

选好选项后，旋转FN旋钮可调节选项。

R-GEL色片一共有30种，分别为02、12、16、17、21、26、33、37、44、47、51、60、62、65、80、88、89、92、93、99、378、2001、2006、2007、2008、3304、4415、4630、4660、4690。

L-GEL色片一共有30种，分别为002、007、008、010、013、036、048、063、075、089、108、110、115、117、124、128、131、134、148、153、156、165、169、182、196、243、244、701、723、724。

色温值可选范围：3200K或5600K。

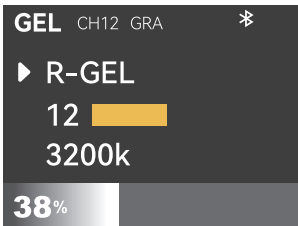

注：更多色片种类可在“Godox light”APP上选择。

5. FX场景光效模式

在FX光效设置界面，短按FN旋钮可选光效类型/光效速度值，共有14类FX场景光效。选好选项后，旋转FN旋钮可调节选项。



光效表 (共14类)

序号	显示	光效类型	选项	调节范围
1		彩光循环	SPD (速度)	1-100
2		派对	SPD (速度)	1-100
3		闪光灯	SPD (速度)	1-100
4		雷闪电	FLICKERS(闪烁次数)	1-10
			FREQ(频率)	RANDOM(随机)/2-20
5		多云	SPD (速度)	1-100
6		坏灯泡	SPD (速度)	1-100
7		电视机	SPD (速度)	1-100
8		蜡烛	SPD (速度)	1-100
9		火	SPD (速度)	1-100
10		烟花	SPD (速度)	1-100
11		爆炸	SPD (速度)	1-100
12		焊接	SPD (速度)	1-100
13		警车	COLOR (颜色)	红+蓝、红、蓝、蓝+白、蓝+黄、黄、红+蓝+白、红+黄+蓝
			MODE (模式)	0-4
14		SOS	CCT (色温)	2500K-10000K

DMX设置

短按DMX按键进入DMX设置界面，旋转FN旋钮可选DMX (地址) /MODE (DMX模式) /LOST (DMX丢失状态)。选中某项后旋转DIM旋钮可调节选项参数。

选项	调节范围	说明
DMX(DMX地址)	OFF/1-512	起始地址
MODE(DMX模式)	CCT 8BIT	8位CCT模式
	HSI 8BIT	8位HSI模式
	RGBW 8BIT	8位RGBW模式
	CCT&HSI 8BIT	8位CCT&HSI模式
	CCT&RGBW 8BIT	8位CCT&RGBW模式
	FX 8BIT	8位FX模式
GEL 8BIT	8位GEL模式	
LOST (DMX丢失状态)	KEEP ON(保持)	失去DMX控制信号后，在关机或再次接收有效DMX控制信号前，灯具保持最后一次接收的DMX控制信号状态
	(BLACK OUT)熄灭	灯具直接熄灭
	(BLACK OUT AFTER 2 MIN)	失去DMX控制信号后，灯具保持最后一次接收的DMX控制信号状态，2分钟后灯具熄灭。注：如2分钟内接收到有效DMX控制信号，则使用新的DMX控制信号。

注：使用DMX控制台控制灯具，可参照附件《S2300R DMX实用表》，电子版可登录官网<https://www.godox.com.cn>下载。

2.4GHz无线设置

短按无线按键进入2.4G无线设置界面，旋转FN旋钮可选频道CH/组别GR/ID号/蓝牙重置。选好选项后，旋转DIM旋钮可调节选项参数或实现重置。

频道CH：可选32个频道(1-32)。

组别GR：可选16个组别(A-F, 0-9)。

ID号：可选OFF(关闭)/99个ID号(1-99)。

蓝牙重置：旋转DIM旋钮即可蓝牙重置，界面出现“RESET”表示重置中，重置完毕，显示屏显示“DONE”并自动返回无线设置界面。

蓝牙MAC码：位于蓝牙复位下方，方便快速找到灯具进行配对。

注：2.4G无线默认开启，使用遥控器RC-R9II时，遥控器的频道、组别、ID号和灯具频道、组别、ID号相同。

“Godox light”APP

扫描二维码即可下载“Godox Light”手机APP (安卓和苹果系统都可以使用)。

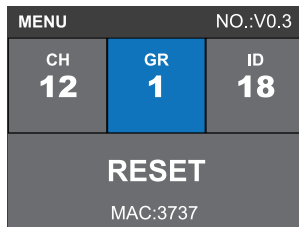

注：蓝牙默认开启，首个移动设备(手机或平板电脑)可直接使用APP操控灯体。更换其他移动设备时，灯体需进行蓝牙重置方可正常使用APP。APP需升级至V3.0以上版本。

固件升级

1. 在官网 <https://www.godox.com.cn/firmware-continuous-light/> 下载新固件到U盘上。
2. 在关机状态下, 将已经存有新固件的U盘接口。
3. 开机, LED 灯自动进入升级界面, 升级后自动跳回主界面。

注: 1. 必须官网下载新固件存放在U盘根目录, 而且只有一个 BIN 文件。
2. USB 口仅用于升级固件。



照度数据

色温	产品测试状态	照度单位	1m	2m	3m
2800K	裸灯	lux	3940	1080	539
		fc	366	101	50.1
	带标罩	lux	28700	6590	2890
		fc	2670	613	269
3200K	裸灯	lux	4620	1270	638
		fc	429	118	59.3
	带标罩	lux	35200	7810	3440
		fc	3270	726	319
4300K	裸灯	lux	6460	1760	887
		fc	600	163	82.4
	带标罩	lux	46300	10600	4700
		fc	4300	987	436
5600K	裸灯	lux	6820	1850	930
		fc	634	172	86.4
	带标罩	lux	48100	11000	4870
		fc	4460	1020	453
6500K	裸灯	lux	5900	1620	806
		fc	548	150	74.9
	带标罩	lux	41400	9510	4200
		fc	3850	883	390
8500K	裸灯	lux	5520	1550	768
		fc	513	144	71.4
	带标罩	lux	38400	9130	3990
		fc	3570	849	371
10000K	裸灯	lux	5420	1530	749
		fc	504	142	69.6
	带标罩	lux	37500	8910	3900
		fc	3480	828	362

以上数据均为平均值, 非绝对值, 测试皆在灯体100%亮度下进行。

规格参数

型号	SZ300R
适配器输出	52V \approx 5.7A
最大输入功率	320W
色温	2500-10000K
调光范围	0%-100%
FX光效	14类
CRI	平均 \approx 96
TLCI	平均 \approx 96
频道	32个 (1-32)
组别	16个 (A-F, 0-9)
ID号	99个 (1-99)
模式	CCT色温模式/HSI彩光模式/RGBW混光模式/GEL色片模式/FX场景光效模式
控制方式	2.4G无线控制/DMX 512控制/蓝牙APP控制/灯体控制
2.4G控制距离	最远50m
蓝牙控制距离	最远30m
变焦	照射角度20°-65°
U型支架调节角度	360°
工作环境温度	-10°C-40°C
尺寸 (含U型支架)	354mm*201mm*378mm
净重(含U型支架) \approx	3.2kg

设计和规格如有变更, 恕不另行通知。

维护保养

为防止灰尘堆积影响产品性能, 请定时用干净的湿布擦拭产品外部。

1年保修, 消耗品适配器、适配器电源线等配件不在此保修范围内。

对于不规范操作引起的机器故障不在保修范围内。

所有维修概由本厂指定的维修部负责。

经发现, 擅自检修本品, 将取消一年保修期, 维修需要收取相关费用。

如果本品出现故障或者被水淋湿, 需在专业人员维修后方可继续使用。

如有技术更改, 恕不另行通知。

本设备包含型号核准代码为: CMIITID:2020DP13510, 为该产品的无线电发射模块。

Safety Instructions and Attentions

First of all, as the most basic principle: This product is a professional lighting set equipment and should be used by professional lighting engineers or under the guidance of professionals. Basic safety attentions must always be followed during use, as follows:

1. Before use, please read and understand these instructions and attentions.
2. Professional lighting is prohibited for children. When children are near, parents or accompanying persons must supervise closely to prevent children from personal injury due to collision with lamps or private use of lamps.
3. This lighting product is not ordinary lighting product and cannot be used for general lighting. Anyone who has suffered eye damage or has sensitive eyes should avoid using this product.
4. When the lamp is on, it must be used with care. Do not touch high-temperature parts, such as LED lamp beads, to avoid burns.
5. When the lamp is on, it is forbidden to look directly at the lamp beads under any circumstances. Strong light should be used under the guidance of professional lighting engineers. Avoid prolonged exposure to strong light under any circumstances. If eye discomfort, please turn off the lamp in time, suspend use, and see a doctor immediately.
6. If the lamp bead is damaged or deformed by heat, stop using this equipment, and contact the manufacturer, service agent or qualified maintenance personnel to replace the lamp bead in time to avoid accidents.
7. This product is only suitable for use in -10°C to 40°C operating environment and normal humidity environment.
8. Do not use damaged equipment or accessories, and wait for professional maintenance personnel to check and repair to confirm being normal before use.
9. During using, if the casing of this product is broken due to being dropped, squeezed or subjected to strong impact, please do not use it, so as to avoid electric shock injury due to contact with internal electronic components.
10. If an extension cord is required, please use an extension cord with a current rating greater than or equal to that of the equipment. If an extension cord is rated less than the equipment, overheating may result.
11. Some products have long power cords, please place the power cords properly and keep them in a safe place. Avoid contacting the power cord with overheating surfaces, avoid improper placement that could cause pulling damage, or trip on-site personnel. Please use the certified power cord from the original manufacturer. If the product is damaged by using a non-certified power cord, it will not be repaired by our factory.
12. Be sure to unplug equipment from the power outlet before cleaning and repairing. When not in use, do not pull the power cord to unplug the equipment. For normal power-off, please hold both ends of the plug of the equipment with your hands and pull the plug out of power outlet. This equipment needs to be connected to a grounded outlet.
13. This equipment is not waterproof, please keep it dry and do not immerse it in water or other liquids. The equipment should be installed in a dry and ventilated place, and avoid using it in rainy, humid, dusty or overheated environments. Do not place any objects on the lamp or let liquid flow into the lamp to avoid accidents.
14. Do not disassemble the product without permission. If the product fails, it must be checked and repaired by authorized maintenance personnel.
15. Before storing, make sure that the equipment has cooled down completely. For storage,

unplug the power cord from the equipment. The equipment should be placed in the carrying case or in a ventilated dry place.

16. Do not place equipment near flammable and volatile solvents such as alcohol and gasoline.
17. Do not use accessories that are not recommended by our factory to avoid fire, electric shock or personal injury.
18. When cleaning, do not wipe it with a damp cloth, please use a dry cloth or a soft cloth to wipe the dirt of the equipment.
19. Please take off the protective cover before using.
20. This product complies with ROHS, CE, and FCC certification, please refer to the relevant national standards for use and operation.
21. The safety instructions are formulated according to the strict testing of the factory, and the design and specifications of the equipment are subject to change without prior notice. For latest product information, please check the GODOX website and view latest electronic instruction.
22. Some products have built-in lithium batteries. Please use specified chargers, and use them within a proper range of the specified voltage and temperature according to the correct operating instructions.
23. Some products are battery powered. Do not use any batteries, power sources or accessories not specified in the instructions for such products. Keep batteries and other accessories out of the reach of children and infants. In the instance that a child or infant swallows a battery or accessory, immediate emergency medical attention is required. If the battery leaks, becomes discolored, deformed, emits smoke, or emits an abnormal odor, remove it immediately. Be careful during removal to avoid burns. Continued use could result in fire, electric shock, or burns. Do not use any deformed or modified batteries. Do not disassemble or modify this product or battery. Do not heat or solder the battery. Keep the battery away from fire or water. Do not incorrectly insert the positive and negative ends of batteries, or mix old and new batteries or batteries of different types together.
24. One-year warranty period, accessories such as consumable batteries, adapters, power cords, etc. are not covered by this warranty.
25. If it is found that the equipment is repaired without authorization, the one-year warranty period will be cancelled and relevant fees will be charged for maintenance.
26. Machine failures caused by non-standard operation are not covered by the warranty.

keep these instructions!

Foreword

Thank you for purchasing!

Zoom RGB LED video light SZ300R is equipped with high output power of 300W, convenient zooming knob, one-key adjustment of illumination angle from 20° to 65°, controllability via optional remote control or "Godox light" app, adjustable CCT/HSI/RGB/GEL/FX modes, and mute mode (fan off) for interference-free shooting scenes. Furthermore, with the standard RJ45 interface, it can be controlled by a console via optional connect cable with 7 DMX modes. It is quite suitable for quite shooting scenes, personal interviews, stage and studio shooting scenes, and outdoor shooting scenes.

Main Features

- Wide CCT range freely adjustable from 2500K to 10000K.
- Three ways of controlling: Bluetooth app/2.4G wireless/light body control.
- HSI mode with 36000 colors and 360° color gamut.
- GEL mode with 60 popular color filters for choice.
- RGBW mode with mixed four colors.
- 14 FX modes: RGB cycle, laser, flash, lightning, cloudy, broken bulb, TV, candle, fire, firework, explosion, welding, police car and SOS.
- Mute mode (fan off) suitable for strictly quite shooting scenes.
- 360° rotatable U-type bracket offers flexibility.

Warning

- ▲ Always keep this product dry. Do not use in rain or in damp conditions.
- ▲ Do not disassemble. Should repairs become necessary, this product must be sent to an authorized maintenance center.
- ▲ Keep out of reach of children.
- ▲ Do not use the flash unit in the presence of flammable gas. In certain circumstance, please pay attention to the relevant warnings.
- ▲ Do not leave or store the product if the ambient temperature reads over 40°C.
- ▲ Do not use the product in the presence of flammable gas. In certain circumstance, please pay attention to the relevant warnings.

Name of Parts

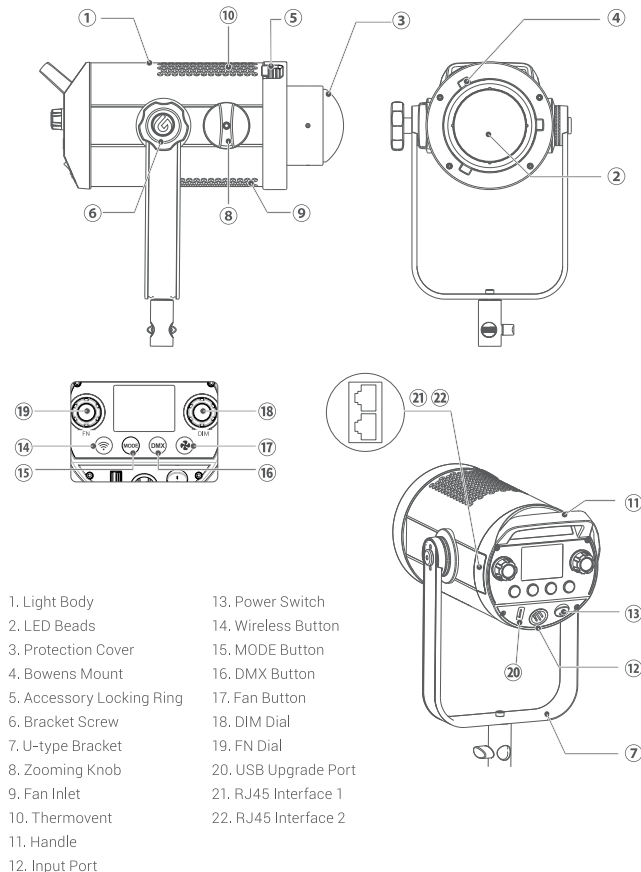

What's Inside

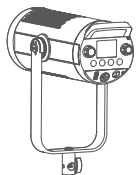

Light Body*1



Protection Cover*1

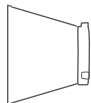

Reflector*1



Steel Rope*1



DMX Practical Table*1



Adapter*1



Power Cable*1



Adapter Holder*1



Carry Bag CB89*1



Instruction Manual*1

Note: Due to continuous updates and upgrades of the products, there may be differences between the actual products and the pictures. Therefore, the pictures are for reference only, products to prevail in kind.

Optional Accessories

The product can be used in combination with the following optional accessories so as to achieve best photography effects: remote control RC-R9II, softbox, umbrella, light stand.

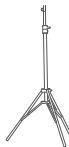

Connect to DMX Controller

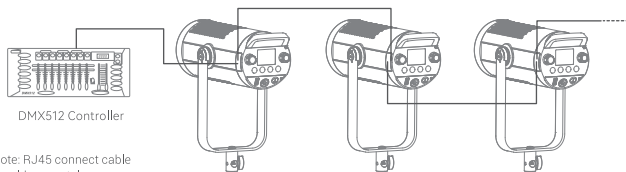

Note: RJ45 connect cable is sold separately.

Power Switch

Toggle the power switch after connected to AC power supply with the adapter to turn on the device.

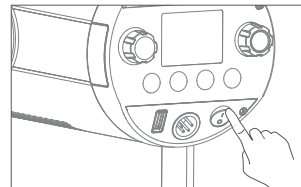

Brightness Adjustment

When the light is in CCT/HSI/RGB/GEL/FX mode, turn the DIM dial can adjust the brightness from 0% to 100%. Turn left to decrease the brightness by one unit while turn right to increase the brightness one unit, with quick adjustment available.

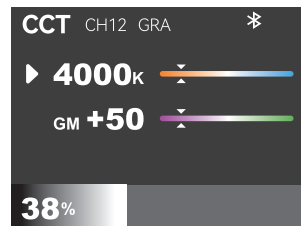

Mute Mode

Short press the fan button to turn on the fan, the icon will not show on the display. Short press it again to turn off the fan, then the icon will show on the display and the light is in mute mode.

The brightness range of CCT/GEL/FX mode is from 0% to 30%.

The brightness range of HSI/RGBW mode is from 0% to 70%.

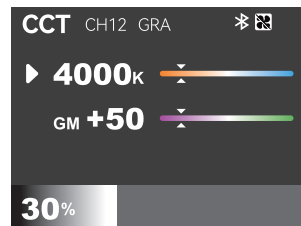

Zooming Setting

Rotate the zoom dial can adjust the illumination angle from 20° to 65°.

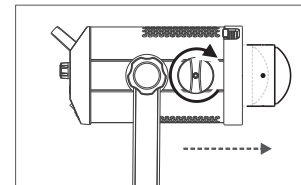

Mode Selection

Short press the MODE button to enter mode selection, then short press the FN dial to select the desired mode, then short press the FN dial to enter mode settings.

1. CCT Mode

Short press the FN dial in CCT setting interface to select CCT adjustment (from 2500K to 10000K) or GM adjustment (from -50 to +50). Turn the FN dial left once can decrease the CCT value by 100K or the GM value by 1 unit, while turn right once can increase the CCT value by 100K or the GM value by 1 unit, with quick adjustment available.

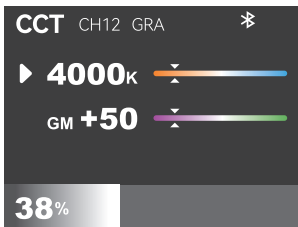

2. HSI Mode

Short press the FN dial in HSI setting interface to select H (hue, adjustable from 0° to 360°) or S (saturation, adjustable from 0% to 100%). Turn the FN dial left once can decrease the hue value by 1 unit or the saturation value by 1 unit, while turn right once can increase the hue value by 1 unit or the saturation value by 1 unit, with quick adjustment available.

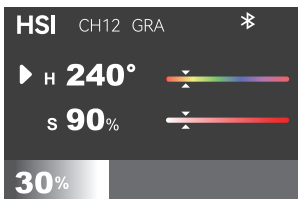

3. RGB Mode

Short press the FN dial in RGB setting interface to select R (red)/G (green)/B (blue)/W (white) (adjustable from 0 to 255). Turn the FN dial left once can decrease the value by 1 unit, while turn right once can increase the value by 1 unit, with quick adjustment available.

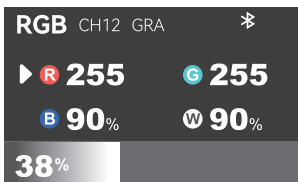

4. GEL Mode

Short press the FN dial in GEL setting interface to select gel type/gel NO./CCT value, then turn to adjust settings.

There are 30 types of R-GEL: 02, 12, 16, 17, 21, 26, 33, 37, 44, 47, 51, 60, 62, 65, 80, 88, 89, 92, 93, 99, 378, 2001, 2006, 2007, 2008, 3304, 4415, 4630, 4660 and 4690.

There are 30 types of L-GEL: 002, 007, 008, 010, 013, 036, 048, 063, 075, 089, 108, 110, 115, 117, 124, 128, 131, 134, 148, 153, 156, 165, 169, 182, 196, 243, 244, 701, 723 and 724.

CCT value adjustable range: 3200K or 5600K.

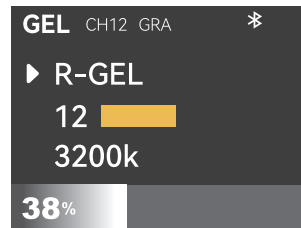

Note: More GEL types are available in "Godox light" APP.

5. FX Mode

Short press the FN dial in FX setting interface to select effect type (14)/speed value. Turn the FN dial can adjust the settings.

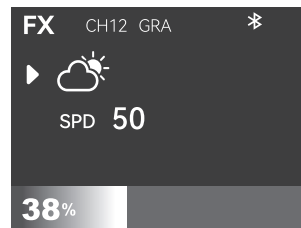

NO.	FX Icon	FX Type	Option	Adjustable Range
1		RGB CYCLE	SPD	1-100
2		PARTY	SPD	1-100
3		FLASH	SPD	1-100
4		LIGHTNING	FLICKERS	1-10
			FREQ	RANDOM/2-20
			SPD	1-100
5		CLOUDY	SPD	1-100
6		BROKEN BULB	SPD	1-100
7		TV	SPD	1-100
8		CANDLE	SPD	1-100
9		FIRE	SPD	1-100
10		FIREWORKS	SPD	1-100
11		EXPLOSION	SPD	1-100
12		WELDING	SPD	1-100
13		POLICE CAR	COLOR	R+B, R, B, B+W, B+Y, Y, R+B+W, R+Y+B
			MODE	0-4
14		SOS	CCT	2500K-10000K

DMX Setting

Short press the DMX button to enter DMX setting interface, turn it to select DMX (address)/MODE (DMX mode)/LOST (DMX lost). Turn the FN dial can adjust the settings.

Option	Adjustable Range	Description
DMX (DMX address)	OFF/1-512	Initial address
MODE(DMX Mode)	CCT 8BIT	CCT 8BIT mode
	HSI 8BIT	HSI 8BIT mode
	RGBW 8BIT	RGBW 8BIT mode
	CCT&HSI 8BIT	CCT&HSI 8BIT mode
	CCT&RGBW 8BIT	CCT&RGBW 8BIT mode
	FX 8BIT	FX 8BIT mode
	GEL 8BIT	GEL 8BIT mode
LOST (DMX Lost)	KEEP ON	After the DMX control signal is lost, continue to use the last received DMX control signal until power down or a valid DMX control signal is received again.
	BLACK OUT	The light is off immediately.
	BLACK OUT AFTER 2 MIN	After the DMX control signal is lost, continue to use the last received DMX control signal for 2 minutes then black out. Note: If a valid DMX control signal is received within 2 minutes, then use the new DMX control signal.

Note: Please refer to the "SZ300R DMX Practical Table" to control the device by DMX. The electronic version can be downloaded from the official website <https://www.godox.com>.

2.4G Wireless Setting

Short press the wireless button to enter 2.4G wireless setting, short press the FN dial to select CH/GR/ID/Bluetooth reset, then turn the DIM dial to adjust settings or reset.

CH: 32 channels (1-32).
GR: 16 groups (A-F/0-9).
ID: 0FF/99 IDs (1-99).

Bluetooth reset: turn the DIM dial until "RESET" on the display means Bluetooth is resetting, it will display "DONE" and return to wireless setting interface automatically after successfully reset.

Bluetooth MAC code: below the Bluetooth reset, for the purpose of pairing.

MENU		NO.:V0.3
CH 12	GR 1	ID 18
RESET		
MAC:3737		

Note: The 2.4G wireless is on by default. When using remote control RC-R9II, the CH, GR and ID of which should be the same with the light body.

"Godox light"APP

Scan the QR code to download "Godox Light" APP (both Android and iOS systems are available).

Note: The Bluetooth is on by default. The APP can be used directly on the firstly installed device (smartphone or tablet). When changing to other mobile device, the light shall be reset before the normal usage of APP. The APP should be V3.0 or above.



Firmware Upgrade

1. Download the new firmware to the U disk from official website (<https://www.godox.com/firmware-continuous-light>).
2. Turn off the device, Insert the U disk with new firmware into the USB upgrade port.
3. Turn on the device, and it will automatically enter the upgrading interface. It will return to main interface after completion.

Notes:

1. New firmware must be downloaded from the official website, and keep only one BIN file in the root directory of the USB disk.
2. The USB port can only support firmware upgrade function.

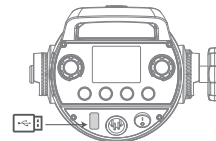

Illuminance Data

CCT	Testing Condition	Unit	1m	2m	3m
2800K	Bare light	lux	3940	1080	539
		fc	366	101	50.1
	With reflector	lux	28700	6590	2890
		fc	2670	613	269
3200K	Bare light	lux	4620	1270	638
		fc	429	118	59.3
	With reflector	lux	35200	7810	3440
		fc	3270	726	319
4300K	Bare light	lux	6460	1760	887
		fc	600	163	82.4
	With reflector	lux	46300	10600	4700
		fc	4300	987	436
5600K	Bare light	lux	6820	1850	930
		fc	634	172	86.4
	With reflector	lux	48100	11000	4870
		fc	4460	1020	453
6500K	Bare light	lux	5900	1620	806
		fc	548	150	74.9
	With reflector	lux	41400	9510	4200
		fc	3850	883	390
8500K	Bare light	lux	5520	1550	768
		fc	513	144	71.4
	With reflector	lux	38400	9130	3990
		fc	3570	849	371
10000K	Bare light	lux	5420	1530	749
		fc	504	142	69.6
	With reflector	lux	37500	8910	3900
		fc	3480	828	362

Note: The above data are average values instead of absolute values. All the above tests are based on the condition of 100% brightness.

Illuminance Data

Model	SZ300R
Adapter Output	52V=5.7A
Max. Input Power	320W
CCT	2500-10000K
Brightness Range	0%-100%
FX Type	14
CRI	Average≥96
TLCI	Average≥96
CH	32 (1-32)
GR	16 (A-F, 0-9)
ID	99 (1-99)
Mode	CCT mode/HSI mode /RGBW mode /GEL mode /FX mode
Controlling Method	2.4G wireless control /DMX 512 control /Bluetooth APP Control/ light body control
2.4G Controlling Distance	Max. 50m
Bluetooth Controlling Distance	Max. 30m
Zooming	Illumination angle 20°~65°
U-type Bracket Adjustable Angle	360°
Working Environment Temperature	-10°C~40°C
Dimension (including U-type bracket)	354mm*201mm*378mm
Net Weight (including U-type bracket)=	3.2kg

Specifications and data may subject to changes without notice.

FCC Statement

This device complies with part 15 of the FCC Rules. Operation is subject to the following two conditions:

- (1) This device may not cause harmful interference, and
- (2) this device must accept any interference received, including interference that may cause undesired operation.

Any Changes or modifications not expressly approved by the party responsible for compliance could void the user's authority to operate the equipment.

Note: This equipment has been tested and found to comply with the limits for a Class B digital device, pursuant to part 15 of the FCC Rules. These limits are designed to provide reasonable protection against harmful interference in a residential installation. This equipment generates uses and can radiate radio frequency energy and, if not installed and used in accordance with the instructions, may cause harmful interference to radio communications. However, there is no guarantee that interference will not occur in a particular installation. If this equipment does cause harmful interference to radio or television reception, which can be determined by turning the equipment off and on, the user is encouraged to try to correct the interference by one or more of the following measures:

-Reorient or relocate the receiving antenna.

-Increase the separation between the equipment and receiver.

-Connect the equipment into an outlet on a circuit different from that to which the receiver is connected.

-Consult the dealer or an experienced radio/TV technician for help.

The device has been evaluated to meet general RF exposure requirement.

The device can be used in portable exposure condition without restriction.

Warning

Operating frequency:2412.99MHz – 2464.49MHz(2.4G only receive)/2402MHz – 2480MHz (BT)
Maximum EIRP Power:7.79dBm

Declaration of Conformity

GODOX Photo Equipment Co.,Ltd. hereby declares that this equipment are in compliance with the essential requirements and other relevant provisions of Directive 2014/53/EU. In accordance with Article 10(2) and Article 10(10), this product is allowed to be used in all EU member states.For more information of DoC, Please click this web link:

<https://www.godox.com/eu-declaration-of-conformity/>

The device complies with RF specifications when the device used at 0mm from your body.

产品保修

尊敬的用户, 本保修卡是申请保修服务的重要凭证, 请您配合销售商填写并妥善保管, 谢谢!

产品信息	型号	产品条码
用户信息	姓名	联系电话
	通信地址	
销售商信息	名称	
	联系电话	
	通信地址	
	销售日期	
备注		

注: 此表应由销售商盖章确认。

产品信息

本文件适用于相关《产品保修信息》(见后面说明)所列产品, 其他非属此范围的产品或部件(如促销品、赠品及其他出厂后附加的部件等)不在此保修承诺内。

保修期

产品及部件的相应保修期按相关的《产品保修信息》执行。保修期自产品首次购买日起算, 购买日以购买产品时保修卡登记日期为准。

如何获得保修服务

您可直接与产品销售商或授权服务机构联系, 也可拨打神牛产品售后服务电话, 与我们联系, 由我们的服务人员为您安排服务。申请保修时, 您应提供有效的保修卡作为保修凭证, 方可获得保修。如您不能提供有效的保修卡, 则在我们确认产品或部件属于保修范围的情况下, 也可以为您提供保修, 但这不作为我们的义务。

不适用保修的情况

如产品存在下列情况, 本文件项下的保证和服务将不适用: ①产品或部件超过相应保修期; ②错误或不适当使用、维护或保管导致的故障或损坏, 如: 不当搬运; 非按产品合理预期用途使用; 不当插拔外接设备; 跌落或外力挤压; 接触或暴露于不适当温度、溶剂、酸碱、水浸或潮湿环境; ③由非神牛授权机构或人员安装、修理、更改、添加或拆卸造成的故障或损坏; ④产品或部件原有识别信息被改变或删除; ⑤无有效保修卡; ⑥使用非法授权、非标准或非公开发行的软件造成的故障或损坏; ⑦因不可抗力或意外事件造成的故障或损坏; ⑧其他非因产品本身质量问题导致的故障或损坏。遇上述情况, 您应向相关责任方寻求解决, 神牛对此不承担任何责任。因非在保修期或保修范围内的部件、附件或软件导致产品不能正常使用的, 不是保修范围内的故障。产品使用过程中正常的脱色, 磨损和消耗, 不是保修范围内的故障。

产品保修和服务支持信息

产品的保修期和服务类型按以下《产品保修信息》执行:

产品类别	选件名称	保修期(月)	保修服务类型
部件	主机	12	客户送修
	电池	3	客户送修
	充电器等带电性能的部件。	12	客户送修
其他	如电源线、同步线闪光灯管、造型灯泡、外壳、保护罩、锁紧装置、包装等。	无	无保修

神牛产品售后服务电话 0755-29609320-8062

Warranty

Dear customers, as this warranty card is an important certificate to apply for our maintenance service, please fill in the following form in coordination with the seller and safe-keep it. Thank you!

Product Information	Model	Product Code Number
Customer Information	Name	Contact Number
	Address	
Seller Information	Name	
	Contact Number	
	Address	
	Date of Sale	
Note		

Note: This form shall be sealed by the seller.

Applicable Products

The document applies to the products listed on the Product Maintenance Information (see below for further information). Other products or accessories (e.g. promotional items, giveaways and additional accessories attached, etc.) are not included in this warranty scope.

Warranty Period

The warranty period of products and accessories is implemented according to the relevant Product Maintenance Information. The warranty period is calculated from the day (purchase date) when the product is bought for the first time. And the purchase date is considered as the date registered on the warranty card when buying the product.

How to Get the Maintenance Service

If maintenance service is needed, you can directly contact the product distributor or authorized service institutions. You can also contact the Godox after-sale service call and we will offer you service. When applying for maintenance service, you should provide valid warranty card. If you cannot provide valid warranty card, we may offer you maintenance service once confirmed that the product or accessory is involved in the maintenance scope, but that shall not be considered as our obligation.

Inapplicable Cases

The guarantee and service offered by this document are not applicable in the following cases: ① The product or accessory has expired its warranty period; ② Breakage or damage caused by inappropriate usage, maintenance or preservation, such as improper packing, improper usage, improper plugging in/out external equipment, falling off or squeezing by external force, contacting or exposing to the improper temperature, solvent, acid, base, flooding and damp environments, etc; ③ Breakage or damage caused by non-authorized institution or staff in the process of installation, maintenance, alternation, addition and detachment; ④ The original identifying information of product or accessory is modified, alternated, or removed; ⑤ No valid warranty card; ⑥ Breakage or damage caused by using illegally authorized, nonstandard or non-public released software; ⑦ Breakage or damage caused by force majeure or accident; ⑧ Breakage or damage that could not be attributed to the product itself. Once met these situations above, you should seek solutions from the related responsible parties and Godox

assumes no responsibility. The damage caused by parts, accessories and software that beyond the warranty period or scope is not included in our maintenance scope. The normal discoloration, abrasion and consumption are not the breakage within the maintenance scope.

Maintenance and Service Support Information

The warranty period and service types of products are implemented according to the following Product Maintenance Information:

Product Type	Name	Maintenance Period(month)	Warranty Service Type
Parts	Circuit Board	12	Customer sends the product to designated site
	Battery	3	Customer sends the product to designated site
	Electrical parts e.g,battery charger, etc.	12	Customer sends the product to designated site
Other Items	Flash tube, power cord, sync cable,modeling lamp,lamp body, lamp cover,lockingdevice, package, etc.	No	Without warranty

Godox After-sale Service Call +86-755-29609320(8062)