

# FIREMAGIC®

## BEVERAGE CENTER

Model # 1D-STA, 1D-SSA, 1D-SSD

### INSTALLATION & OWNER'S MANUAL

**INSTALLER:** Leave these instructions with consumer.  
**CONSUMER:** Retain for future reference.



**IMPORTANT:** READ ALL INSTRUCTIONS CAREFULLY BEFORE STARTING INSTALLATION OR USE.

### WARNINGS AND SAFETY CODES

All electrical outlets in the vicinity of the unit must be properly grounded in accordance with local codes, or, in the absence of local codes, with the *National Electrical Code, ANSI/NFPA 70*, or the *Canadian Electrical Code, CSA C22.1*, whichever is applicable.

Keep all electrical-supply cords away from any heated surface.

**Electrical Grounding Instructions - This appliance is equipped with a three-prong (grounding) plug for your protection against shock hazard and should be plugged directly into a properly grounded three-prong receptacle. Do not cut or remove the grounding prong from this plug.**

The minimum inlet water-supply pressure is 7 psi. The maximum inlet water-supply pressure is 80 psi. DO NOT INSTALL THE APPLIANCE IF MAXIMUM PRESSURE IS EXCEEDED.

To protect against electric shock, do not immerse cord or plugs in water or other liquid.

Unplug from the outlet when not in use and before cleaning.

Do not operate any appliance with a damaged cord, plug, or after the appliance malfunctions or has been damaged in any manner. Contact the manufacturer for repair.

Do not let the cord hang over the edge of a table or touch hot surfaces.

When connecting, first connect the power supply box to the appliance then plug the appliance into the outlet.

**Use only a properly wired and inspected 120VAC (15 AMP minimum) Ground Fault Circuit Interrupter (GFCI) GROUNDED 3-wire receptacle with this appliance.**

The GFCI receptacle must be a WEATHER-PROOF IN-USE COVERED RECEPTACLE.

Never remove the grounding plug or use with an adapter of 2 prongs.

Use only extension cords with a 3 prong grounding plug, rated for the power of the equipment, and approved for outdoor use with a W-A marking.

**The provisions of the National Electric Code as well as any local codes must be observed when installing the product.**

# MODEL SPECIFICATIONS

Input electrical requirements	<b>120VAC / 15 AMP minimum / 60 Hz / GFCI outlet</b>
Power supply fuse	T6.3AL (250V)
Interior oven lights rating	<b>12V / 10 watt halogen bulb</b>

**Table 1 - Product Specifications**

<b>Counter Cut-out Dimensions</b>	
<b>Counter Opening Height</b>	<b>12"</b>
<b>Counter Opening Width</b>	<b>36-3/4"</b>
<b>Counter Opening Depth</b>	<b>23-1/2"</b>

**Table 2 - Cutout Dimensions**

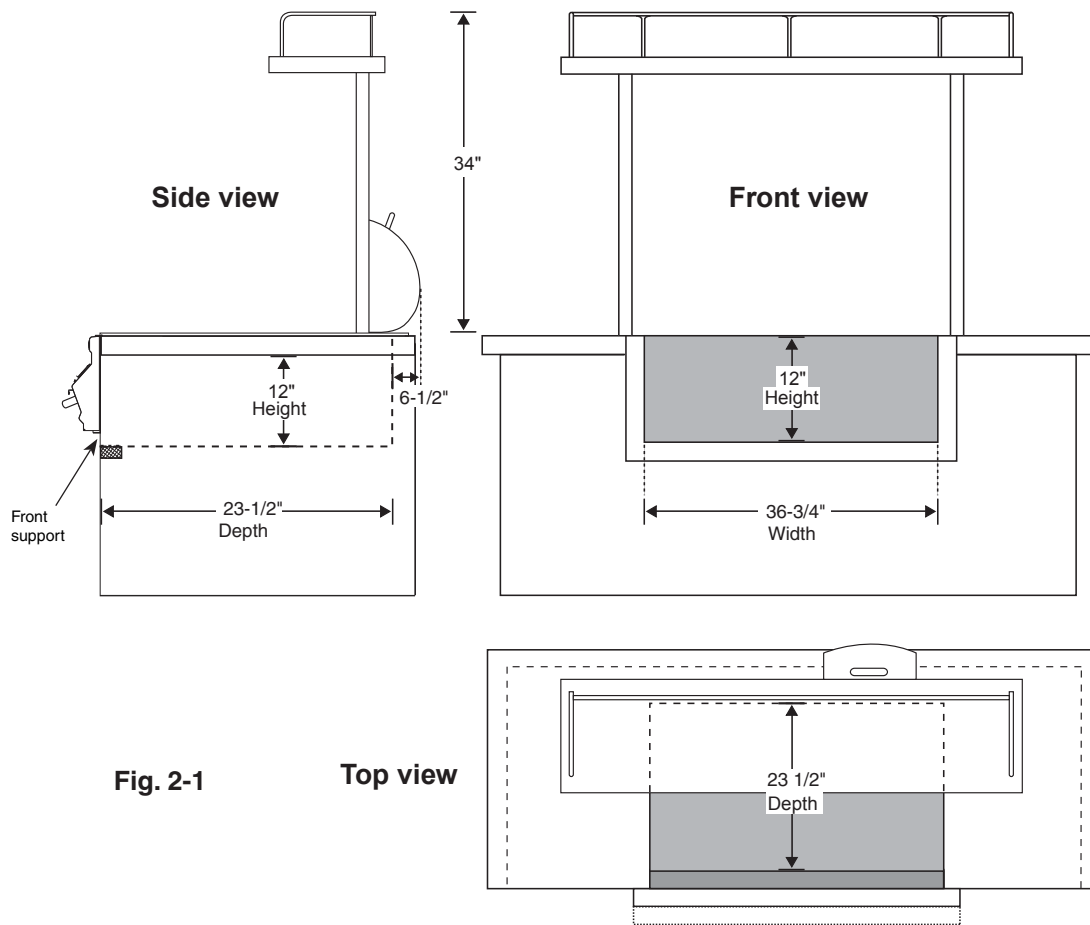

Note additional clearance required to the rear for the blender cover to open fully.

# REPLACEMENT PARTS LIST

Item	Description	Part No.	Qty.
1.	Sink	3587	1
2.	Faucet	3588	1
3.	Blender kit	3284-2	1
4.	Cutting board	1D-S-07	1
5.	Condiment holder with lid	1D-S-09	2
6.	Power supply box *	24187-64	1
7.	Overhead light lens * †	24187-26	2
8.	Overhead light bulb * †	24187-15	2
9.	Storage drawer (w/ glides) or Diamond storage drawer (w/ glides)	1D-S-12 1D-SD-12	1 1
10.	Insulated ice drawer (w/ glides) or Diamond insulated ice drawer (w/ glides)	1D-S-11 1D-SD-11	1 1

\* if equipped

† not shown

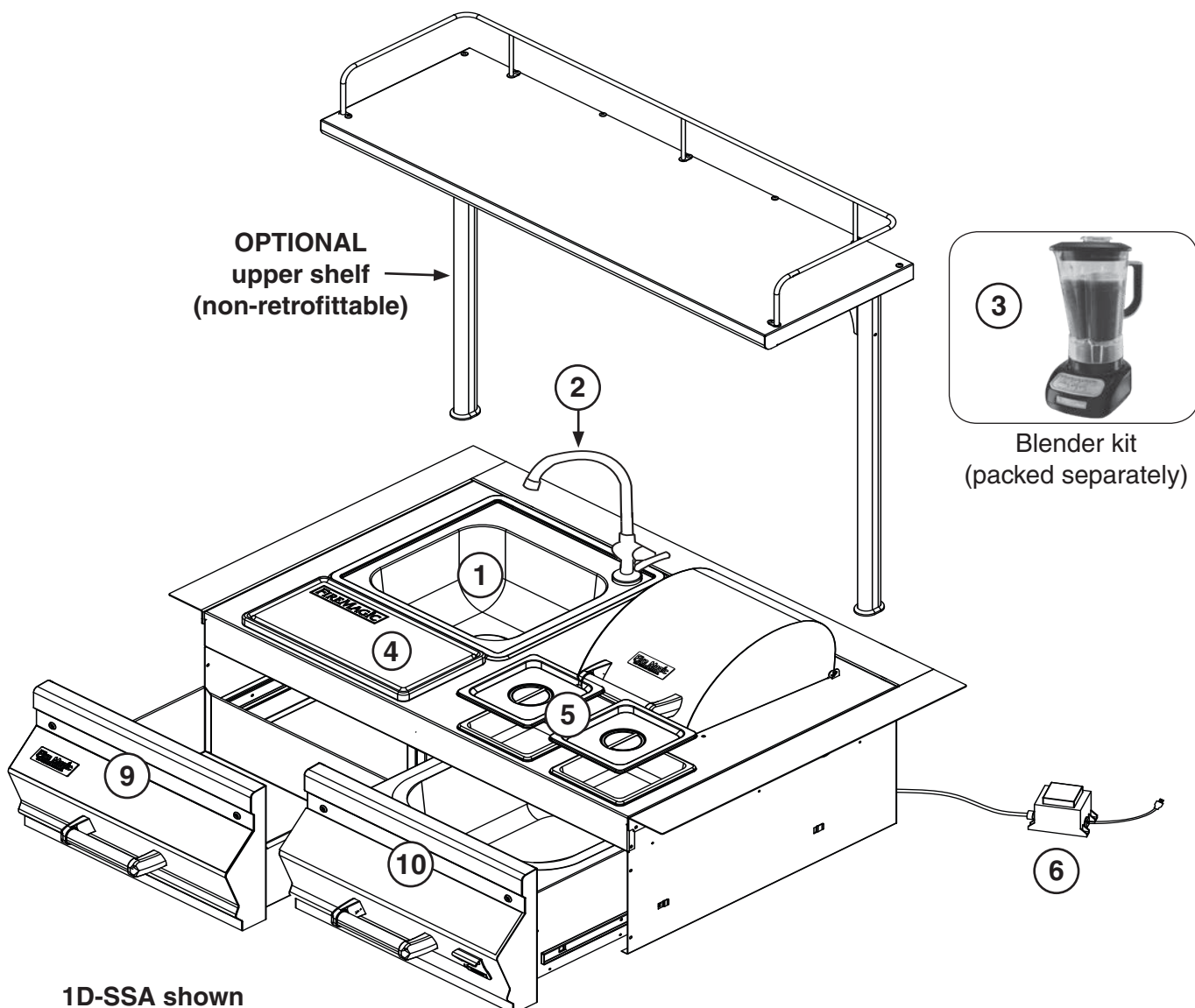

## INSTALLATION

Installation must be performed by a qualified professional service technician.

### WATER SUPPLY SETUP

The water supply is to be plumbed into the enclosure and to the faucet. The faucet's water fitting ( $\frac{1}{2}$ " NPS) is attached to the bottom of the faucet. Your individual installation may vary. **Observe the National Plumbing Code and all local codes.**

1. Plumb the water supply into the enclosure area.

**Note:** It is recommended that a water shut-off valve (not included) be attached to the water supply line. It can be installed remotely or at the end of the water supply line.

### DRAIN SETUP

A permanent waste drain is to be plumbed from an appropriate drain into the enclosure and to the sink. The sink's plastic trap and drainpipe extend just below the sink. Your individual installation may vary. **Observe the National Water and Safety Code and all local codes.**

1. Plumb the drain into the enclosure area.

Alternatively, a waste water container may be placed under the sink.

### ELECTRICAL SETUP (if applicable)

A **120VAC (15 AMP minimum) GFCI GROUNDED 3-wire receptacle** (not included) is required within the vicinity of the appliance to provide power to the unit. The GFCI receptacle must be a **WEATHER-PROOF IN-USE COVERED RECEPTACLE**. The unit's power supply cord is located on the rear of the power supply box. Your individual installation may vary. **Observe the National Electric Code and all local codes.**

1. Wire the receptacle into the enclosure area. It will need to be located beneath the countertop, and within 5 feet of the blender base.
  - **Verify proper polarity of the receptacle.**
  - **If an extension cord is used, ensure it is a 3-wire GROUNDED cord that is rated for the power of the equipment, and is approved for outdoor use with a W-A marking. DO NOT use 2-prong adapters.**
  - **DO NOT TAMPER WITH THE EXTENSION CORD OR THE UNIT POWER-SUPPLY CORD.**

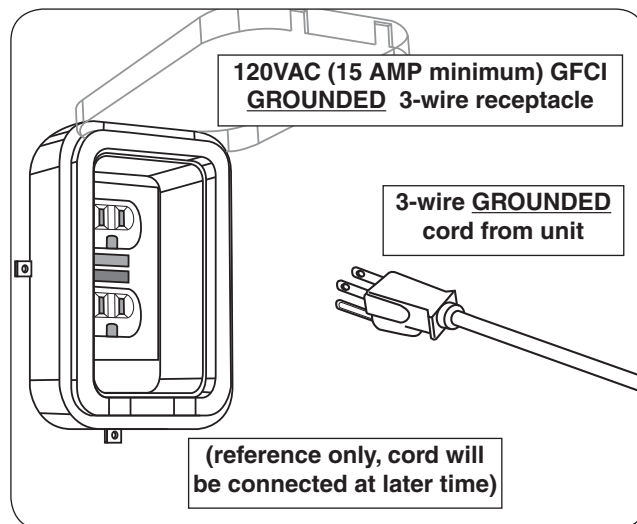

Fig. 4-3 Electrical setup detail

### CONSTRUCT ENCLOSURE

1. Construct the enclosure according to your individual install preference, while following the guidelines in the SPECIFICATIONS section, and the WATER SUPPLY, DRAIN, and ELECTRICAL setup sections above.
2. Prepare a cut-out in the countertop as specified in the SPECIFICATIONS section.
3. If equipped, install the power supply box near the GFCI receptacle and within reach of the wires coming from the beverage center (once installed).

Installation continued on next page

### INSTALL BEVERAGE CENTER

1. After the enclosure and all electrical and plumbing hookups are prepared, place the beverage center into the cut-out. Keep all electrical wires from being pinched between the beverage center and the enclosure.

**Note:** The unit will rest on the countertop by its stainless-steel hanger and on the front structural support of the enclosure.

2. If applicable, the wire harness coming from the rear of the unit must be connected to the power supply box by inserting the two pins and screwing in the nut.

3. Ensure the unit is completely slid into the cutout.

**Note:** Silicon sealant may be applied around the top edge of the countertop cut-out to create a barrier between the housing and countertop.

### CONNECT PLUMBING

The faucet has a water fitting attached to its bottom; the sink has a drainpipe attached to it.

**Note:** Your individual installation may vary. Use sealants as needed. **Observe the National Water and Safety Code and all local codes.**

1. Locate the water supply that is within the enclosure (previously routed at beginning of installation). Plumb the water supply to the 1/2" NPS fitting on the faucet.
2. Locate the drain that is within the enclosure (previously routed at beginning of installation). Plumb the drain to the drainpipe on the sink.

Alternatively, a waste water container may be placed under the sink.

3. Check at all connections for leaks. If a leak is present, turn off the water and tighten at all connections. Repeat until no leaks are present. If a leak persists, turn off the water supply and contact a professional service technician.

### CONNECT POWER SUPPLY CORD (if applicable)

Route the power supply cord (coming from power supply box) to the previously wired **120VAC (15 AMP minimum) GFCI GROUNDED 3-wire receptacle** and connect.

Installation continued on next page

## INSTALLATION (cont.)

### PLACE BLENDER IN BLENDER MOUNTING

Open the domed lid. Unpack the blender and read the instructions.

Remove the tray located on top of the counter in front of the domed lid. Then attach the provided plastic plug to the blender electrical cord. Feed the cord through the cutout that is located at the rear of the tray opening. Be sure to snap the plastic plug in place. Then replace the tray. See Fig. 6-1. From there, route the cord through the unit and to the GFCI receptacle.

Ensure the blender rests in the tray in front of the domed lid.

See blender instructions for additional details on blender installation, use, and maintenance. Test the blender and electrical connection by applying and turning off power without the container in place.

### PLACE THE CUTTING BOARD

Unpack the wood cutting board and place the four (4) rubber feet into the four (4) depressions on top of the counter in front of the sink (Fig. 6-2). The cutting board is designed to stay firmly in place while in use and yet be easy to remove, clean, and store as needed.

### PLACE THE STAINLESS-STEEL CONDIMENT STORAGE CONTAINERS

Unpack the stainless-steel condiment storage containers with lids. Place them in the rectangular holes in the top of the counter in front of the blender. Cover them with the rectangular lids (Fig. 6-3).

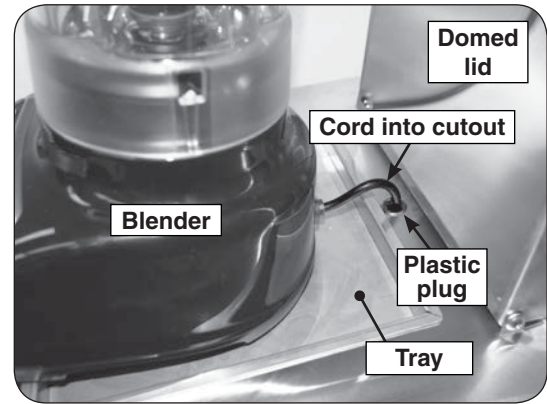

Fig. 6-1 Blender placement (side view)

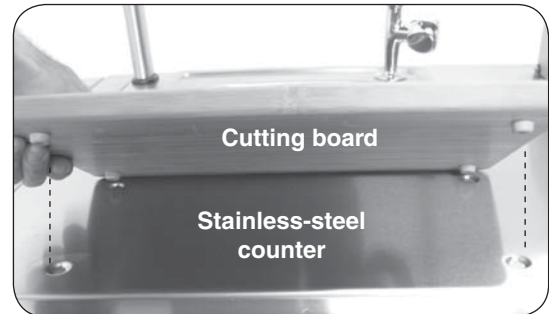

Fig. 6-2 Match cutting board feet to holes



Fig. 6-3 Slide containers into countertop

## OPERATION

### TURNING THE LIGHTS ON AND OFF (if equipped)

**Note:** The beverage center must be plugged in to a **120VAC (15 AMP minimum) GFCI GROUNDED 3-wire receptacle.**

Locate the button underneath the right side of the light panel. Press the button to turn on and off the two halogen lights underneath the rack (see Fig. 7-1).

### USING MAGNETIC BOTTLE OPENER

A magnetic bottle opener is located on the right side drawer. To use simply insert the top of the bottle as shown in Fig. 7-2 and pull the bottom of the bottle downward until the cap is removed. The cap will then stick to the magnet instead of falling to the ground. Remove the cap from the magnet and discard.

### DRAWERS

The left top drawer (Fig. 7-3) is for tool/utensil storage. The blender container and other such items may be stored effectively in this drawer.

The right top drawer is for storage of clean ice. Open the drawer, make sure the drain plug is in place (Fig. 7-4), and pour the ice into the basin. Close the drawer to protect the ice from wind and debris and to keep it shaded.

To drain the top right ice drawer, completely pull it out, then remove the drain plug and allow the melted ice to drain. DO NOT close the door until all water has drained. Wipe out and clean as needed.

To remove a drawer; pull it completely out. Release the drawer from the drawer slides by pressing the black lever down on the right side, and up on the left side (Fig 7-5). Then lift upward and outward on the drawer until it comes free of the runners.

To re-attach a drawer; extend the drawer slides completely and align the drawer into the slides, pushing the drawer closed. Open the drawer to verify that it has locked in place.

### STORAGE SHELF

The total weight on the upper storage shelf must not exceed 35 pounds.

### WINE GLASS RETAINER (if equipped)

Place wine glasses as shown in Fig. 7-6. Do not force.

### BLENDER

See the blender instructions for complete information on operation.

**WARNING:** DO NOT use the blender in the rain or wet conditions.

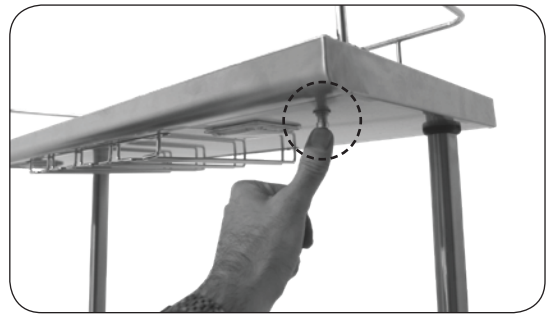

Fig. 7-1 Using light switch



Fig. 7-2 Magnetic bottle opener (right drawer)



Fig. 7-3 Left storage drawer



Fig. 7-4 Clean ice storage drain plug

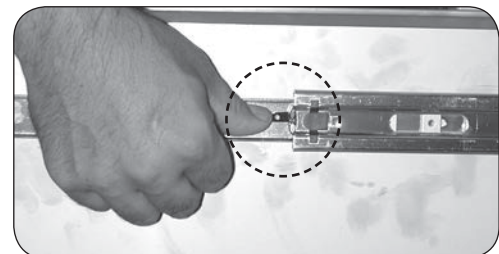

Fig. 7-5 Release drawer slider prior to removal

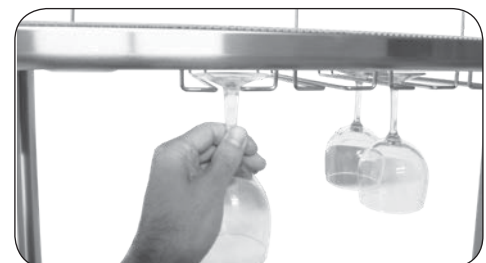

Fig. 7-6 Glass storage racks under top (if equipped)

## SERVICING AND CLEANING

### CHANGING THE BULBS (if equipped)

**Important:** ONLY REPLACE WITH 12V / 10 WATT HALOGEN BULB(S).

**WARNING:** To protect from potentially sharp sheet metal and glass, wear gloves and safety glasses during this procedure.

1. Turn off all electrical sources.

**Important:** Place one hand directly below the glass lens and prepare to catch it when it is detached.

2. Carefully insert a standard flat head screwdriver or a thin plastic spatula between the glass lens and the stainless steel on which the light is mounted, and gently pry the glass lens out in such a way that the stainless steel is not scratched (twisting the screwdriver handle, for instance). See Fig. 8-1. Catch the lens (Fig. 8-2) and set it safely aside.

**Note:** You may wish to take this opportunity to clean the lens with a standard household window cleaner and then dry it completely.

3. Wearing a pair of gloves, reach into the fixture, gently grab the bulb (Fig. 8-3), and pull it straight out of the fixture so that the two pins at the base of the bulb come all the way out.

**Important:** Bulb is halogen. **DO NOT TOUCH** with bare hands. Oils from hands drastically reduce bulb life.

**Note:** It may be helpful to rock the bulb gently backward and forward while pulling it out.

4. Inspect the old bulb for broken glass or filament.

**Note:** It may be beneficial to test the suspect bulb in the other light fixture known to be working and turn the power back on to be certain the bulb is actually not working.

5. Insert the new **12V / 10 watt halogen bulb** into the socket so that both pins slide all the way into the two holes in the bottom of the socket.

6. Place the lens back into the fixture opening with the curved cut-out toward the back and snap it back into place.

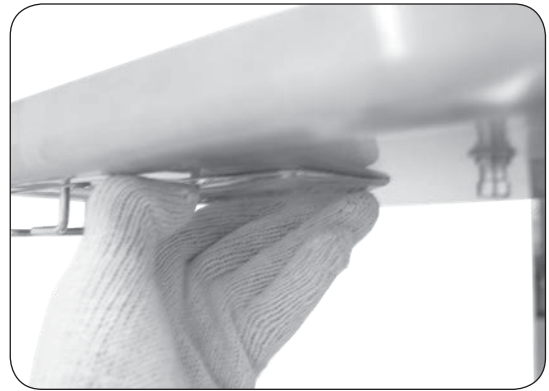

Fig. 8-1 Pry glass lens out

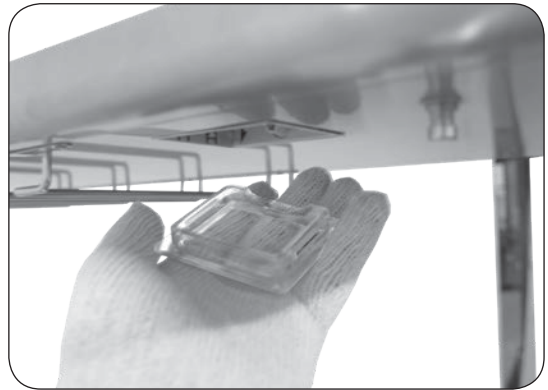

Fig. 8-2 Catch lens and set aside



Fig. 8-3 Remove bulb



### WASTE WATER CONTAINER (if applicable)

If a waste water container exists beneath the sink (instead of a drainpipe), the container must then be periodically checked and emptied when full.

### CARE AND CLEANING

#### Blender

Reference the separate blender instructions for cleaning.

Store the blender container in a drawer and close the stainless-steel lid over the blender base to protect it when not in use.

#### Beverage Center

**Note:** You may find it useful to first remove the blender from the stainless-steel housing when cleaning the beverage center (see the PLACE BLENDER IN BLENDER MOUNTING section).

Clean up spills as required with a damp cloth / sponge and a non-abrasive low-acid cleaning solution. For heavy cleaning, use stainless steel grill cleaner to remove grease and dirt. Always wipe with the grain (See Fig. 9-1). Next, apply stainless steel polish and wipe down using polish wipes to restore the stainless steel color. **To clean the glass light lens covers, use a quality brand glass cleaner only, not any of the cleaners mentioned above.**

If your appliance is installed in a seaside (salt air) or poolside (chlorine) location, it will be more susceptible to corrosion and must be maintained/cleaned more frequently. Do not store chemicals (such as chlorine or fertilizer) near your stainless steel appliance.

Due to the nature of stainless steel, surface iron oxide deposits may appear. Do not be alarmed – these deposits are removable with stainless steel cleaner through prompt and periodic maintenance. If not attended to promptly, permanent pitting may occur.

By following these recommendations, you will enjoy the beauty and convenience of your appliance for many years to come.

#### Beverage Center Cover

To protect your unit and reduce the need for cleaning, cover your beverage center between uses with an optional Fire-Magic® custom cover. Please specify the model number of your unit when ordering a cover.

Always remove items from the upper storage area before covering.

Uncover the beverage center with care. Always lift or slide the cover gently off the upper storage rack. Never pull sideways, as the rack may be damaged or loosened.

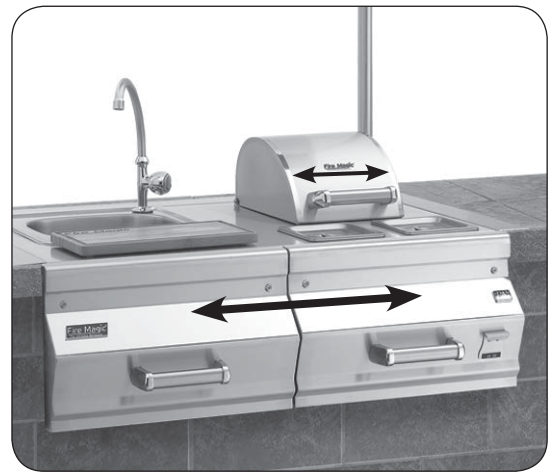

Fig. 9-1 Wipe with grain

# WARRANTY

## PETERSON FIRE MAGIC GRILLS AND ACCESSORIES

### LIMITED WARRANTY

Robert H. Peterson Co. ("RHP") warrants your Fire Magic® grill to be free from defects in material and workmanship.

Fire Magic® cast stainless-steel burners, Choice stainless steel tubular burners, stainless-steel cooking grids, and stainless-steel housings are warranted for as long as you own your Fire Magic® grill -- **LIFETIME**. (Except as noted below.)

Fire Magic® brass valves, inner liners, manifold assemblies, porcelain housings (including ovens and barbecue faces), and backburner assemblies (except ignition parts) are warranted for **FIFTEEN (15) YEARS**.

Fire Magic® built-in and portable griddles (except ignition parts) are warranted for **TEN (10) YEARS**.

Fire Magic® Electric Grills, including stainless steel grid, and housings are warranted for **TEN (10) YEARS**.

Fire Magic® Infra-red burners, flavor grids, Charcoal stainless steel grills, and Smokers are warranted for **FIVE (5) YEARS**; except for the charcoal pan, charcoal grid, wood pellet screen, thermometer, and ash tray; which are warranted for **ONE (1) YEAR**.

Fire Magic® sideburners and all other Fire Magic® grill components (except ignition and electronic parts) are warranted for **THREE (3) YEARS**.

Fire Magic® grill and griddle ignition systems (excluding batteries), electronic components (including lights and thermometers), and grill accessories are warranted for **ONE (1) YEAR**.

#### A COPY OF YOUR SALES SLIP FOR PROOF OF PURCHASE IS REQUIRED

This warranty applies to the original purchaser for products which are installed in the United States or Canada and which are operated and maintained as intended for single family residential usage. This warranty is valid only with proof of purchase, shall commence on the date of purchase, and shall terminate (both as to original and any replacement products) on the anniversary date of the original purchase of the product stated on the above schedules.

This warranty covers defects in material and workmanship. This warranty **does not** cover parts which become defective as a result of negligence, misuse, use not in compliance with the Owner's Manual/Installation Instructions, accidental damage, improper handling, improper storage, improper installation, **lack of required routine maintenance** (as specified in the Owner's Manual/Installation Instructions), or electrical damage. Product must be installed as specified in the Owner's Manual/Installation Instructions by a **qualified professional installer**. Modifications to products which are not specifically authorized will void this warranty. Accessories, parts, valves, remotes, etc. when used must be Peterson products or this warranty is void. Warranted items will be repaired or replaced at Peterson's sole discretion. This warranty **does not** apply to rust, corrosion, oxidation, or discoloration unless the affected part becomes inoperable.

This warranty **does not** cover labor or labor related charges, except as provided by separate specific written programs from the Peterson Co. All repair work must be performed by a qualified professional service person and requires prior approval of Peterson.

Peterson may require the defective product or part to be returned to the factory to determine the cause of failure. Peterson will pay freight charges if the product or part is determined to be defective. This warranty does not cover breakage in shipment from our (Independent) distributor to its customer if the damage is determined to have occurred during that shipment.

This warranty specifically excludes liability for **indirect, incidental, or consequential damages**. Some states and provinces do not allow the exclusion or limitation of incidental or consequential damages, so the above exclusion may not apply to you. This warranty gives you specified legal rights, and you may have other rights that vary from state to state or province.

For additional information regarding this warranty, or to place a warranty claim, contact the R. H. Peterson dealer where the product was purchased.

When contacting your Peterson dealer or the R. H. Peterson Co., please provide the following information:

- Your name, address, telephone number, e-mail
- Sales receipt showing where purchased and date purchased
- Model number, serial number of product, date code
- Relevant information: installer, additions, repairs, when defect was first noted

**TO REGISTER YOUR PRODUCT ONLINE GO TO: [WWW.RHPETERSON.COM](http://WWW.RHPETERSON.COM),  
AND CLICK ON PRODUCT REGISTRATION. THANK YOU FOR YOUR PURCHASE.**