

C7400A and C7400C Enthalpy Sensors

PRODUCT DATA

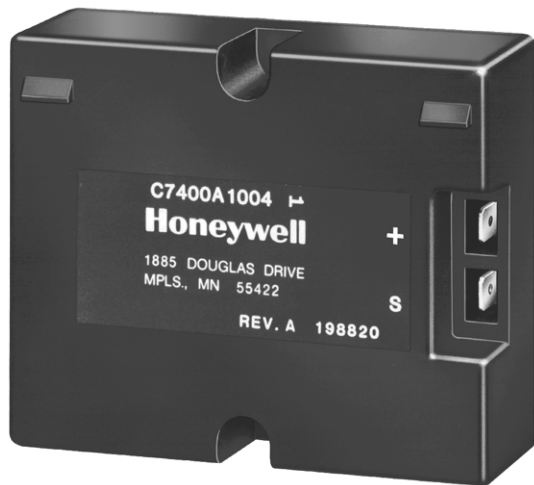

FEATURES

- Senses and combines temperature and humidity of outdoor air.
- Long lasting thermistor sensing element is accurate and stable over time.
- As enthalpy of outdoor air increases, the outdoor air damper closes to a preset minimum position.
- As enthalpy of outdoor air becomes low, the outdoor air damper opens to reduce the mechanical cooling load in the building.
- Maximum economizer savings is achieved when two C7400 Enthalpy Sensors are used for differential enthalpy changeover control.
- Compact size and lightweight construction allows easy mounting in HVAC rooftop unit.
- Sensor is enclosed in a rugged, corrosion-resistant glass-fiber reinforced plastic duct-mount case.
- Provides a 4 to 20 mA output signal to Economizer Logic Module; setpoint is located on the logic module.

APPLICATION

The C7400A Enthalpy Sensor is used with the economizer logic modules with the A,B,C, and D performance curves; the C7400C sensor is used with the logic modules with the A,B,C,D, and E performance curves. The sensors combined with the economizer logic modules permit the use of outdoor air as the first stage of cooling in heating, ventilating and air conditioning (HVAC) systems.



SPECIFICATIONS

Models:

C7400A enthalpy sensor for use with economizer logic modules with A,B,C, and D performance curves.

C7400C enthalpy sensor for use with economizer logic modules with A,B,C,D, and E performance curves.

Dimensions: See Fig. 1

Output Signal: 4 to 20 mA current signal increases from 4 mA to 20 mA as enthalpy decreases.

Ambient Temperature Ranges:

Shipping: -40°F to 150°F (-40°C to 66°C)

Operating: 32°F to 125°F (0°C to 52°C)

Maximum Power Consumption: 0.50 VA at 24 Vdc

Supply Voltage: 12 to 40 Vdc

Electrical Connections:

Two 1/4 in. (6 mm) quick connect terminals.

Approvals:

Underwriters Laboratories Inc. Flammability Rating: UL94-5V.

INSTALLATION

When Installing this Product...

1. Read these instructions carefully. Failure to follow them could damage the product or cause a hazardous condition.
2. Check the ratings given in the instructions and on the product to make sure the product is suitable for your application.
3. Installer must be a trained, experienced service technician.
4. After installation is complete, check out product operation as provided in these instructions.
5. Verify polarity of wiring connections from sensor to logic module are correct.

CAUTION

Electrical Shock or Equipment Damage Hazard.
Can shock individuals or short equipment circuitry.

Disconnect power supply before installation.

ORDERING INFORMATION

When purchasing replacement and modernization products from your TRADELINE® wholesaler or distributor, refer to the TRADELINE® Catalog or price sheets for complete ordering number.

If you have additional questions, need further information, or would like to comment on our products or services, please write or phone:

1. Your local Honeywell Automation and Control Products Sales Office (check white pages of your phone directory).
2. Honeywell Customer Care
 1985 Douglas Drive North
 Minneapolis, Minnesota 55422-4386

In Canada—Honeywell Limited/Honeywell Limitée, 35 Dynamic Drive, Toronto, Ontario M1V 4Z9.

International Sales and Service Offices in all principal cities of the world. Manufacturing in Australia, Canada, Finland, France, Germany, Japan, Mexico, Netherlands, Spain, Taiwan, United Kingdom, U.S.A.

Follow specific installation instructions furnished by the HVAC equipment manufacturer. If not available, use this procedure.

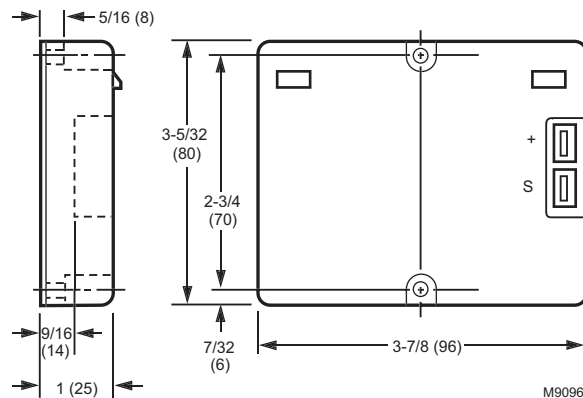

Fig. 1. Approximate dimensions of C7400A Enthalpy Sensor in inches (mm).

Location

IMPORTANT

When selecting the location, make sure the C7400 Enthalpy Sensor is not exposed to rain, snow or direct sunlight.

NOTES:

- The C7400 Sensor can be mounted in any position. However, the sensor must be installed where it is exposed to freely circulating air, but protected from rain, snow and direct sunlight.
- Differential enthalpy control requires two C7400 Sensors. Mount one sensor in the outdoor intake duct, the other in the return air duct.
- The C7400 Sensor is designed to operate in 500 ft./min. minimum airflow.

Wiring

IMPORTANT

All wiring must agree with applicable codes, ordinances and regulations.

Follow the wiring information furnished by the HVAC equipment manufacturer or see Fig. 2 for typical wiring hookups.

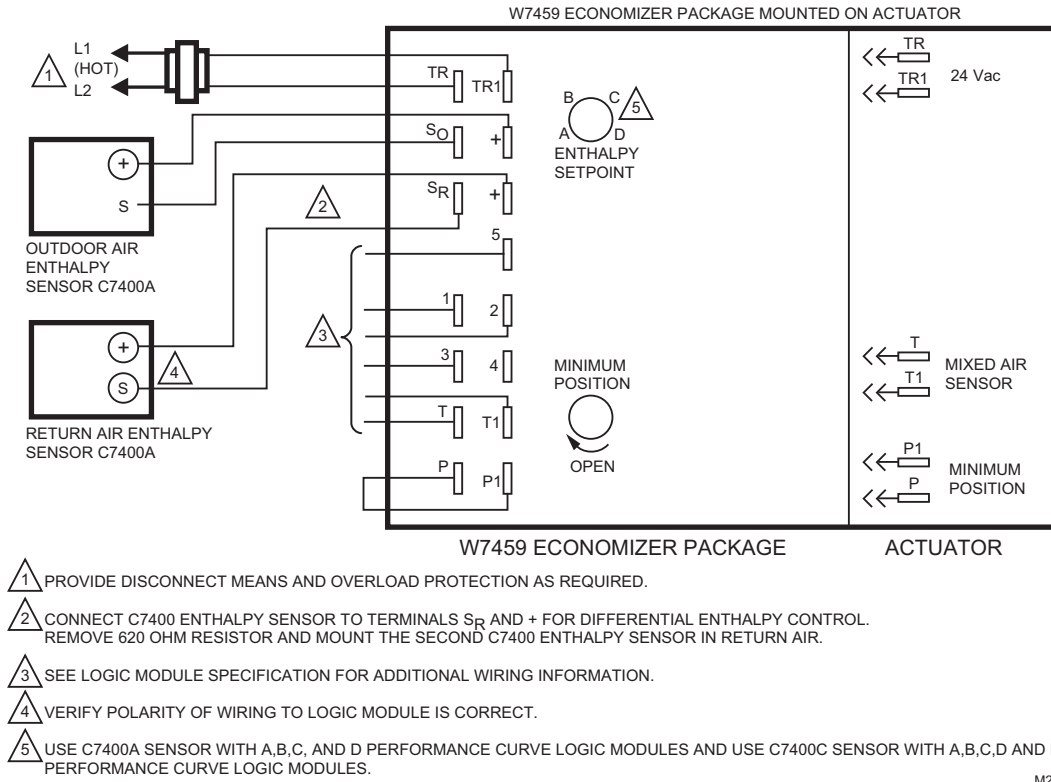



Fig. 2. Wiring connections for C7400 Enthalpy Sensors.

OPERATION

Controller Dial Setting

Control setpoint scale is located on the logic modules. Control points (A,B,C,D, and E) are field selectable and are used for single enthalpy sensing. Turn to D or E (fully clockwise ) when differential enthalpy control is desired. When differential enthalpy control is desired, two enthalpy sensors must be connected to the economizer logic module. See Fig. 2 on page 3.

Operation

The C7400 Enthalpy Sensor is used with an economizer logic module and damper actuator to proportion an outdoor air damper in a ventilation system.

Each enthalpy control setpoint (A,B,C, and D) or (A,B,C,D, and E) combines temperature and humidity conditions, resulting in the control curve shown in Fig. 5 and 6. When the

enthalpy of the outdoor air is below (left of) the appropriate curve, the outdoor air damper can proportion open on a call for cooling from the space thermostat. If the outdoor enthalpy rises above (right of) the control curve, the outdoor air damper closes to the minimum position.

NOTE: Curves illustrate reset in temperature control point due to changes in relative humidity.

For differential enthalpy, turn the control setpoint to D or E (fully clockwise ):

- If outdoor air enthalpy is lower than return air enthalpy, the outdoor air damper proportions open on a call for cooling.
- If outdoor air enthalpy is higher than return air enthalpy, the outdoor air damper closes to minimum position. Differential enthalpy control provides energy savings and increased comfort by using the air with the lowest enthalpy.
- If outdoor air enthalpy and return air enthalpy are equal, the outdoor air damper proportions open on a call for cooling.

NOTE: The relationship between the C7400 Sensor output current and relative humidity is shown in Fig. 3 and 4.

C7400A AND C7400C ENTHALPY SENSORS

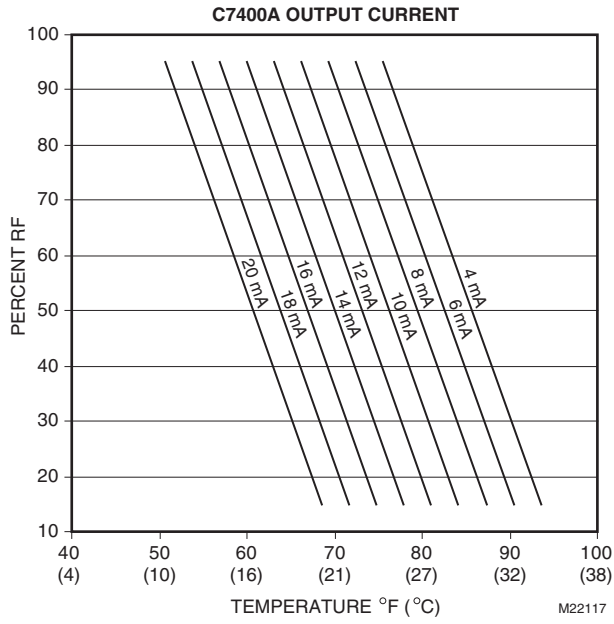

Fig. 3. C7400A Sensor output current versus RH.

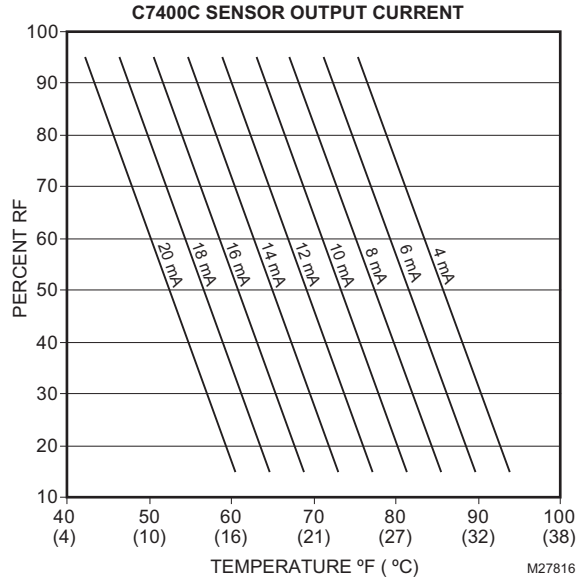

Fig. 4. C7400C Sensor output current versus RH.

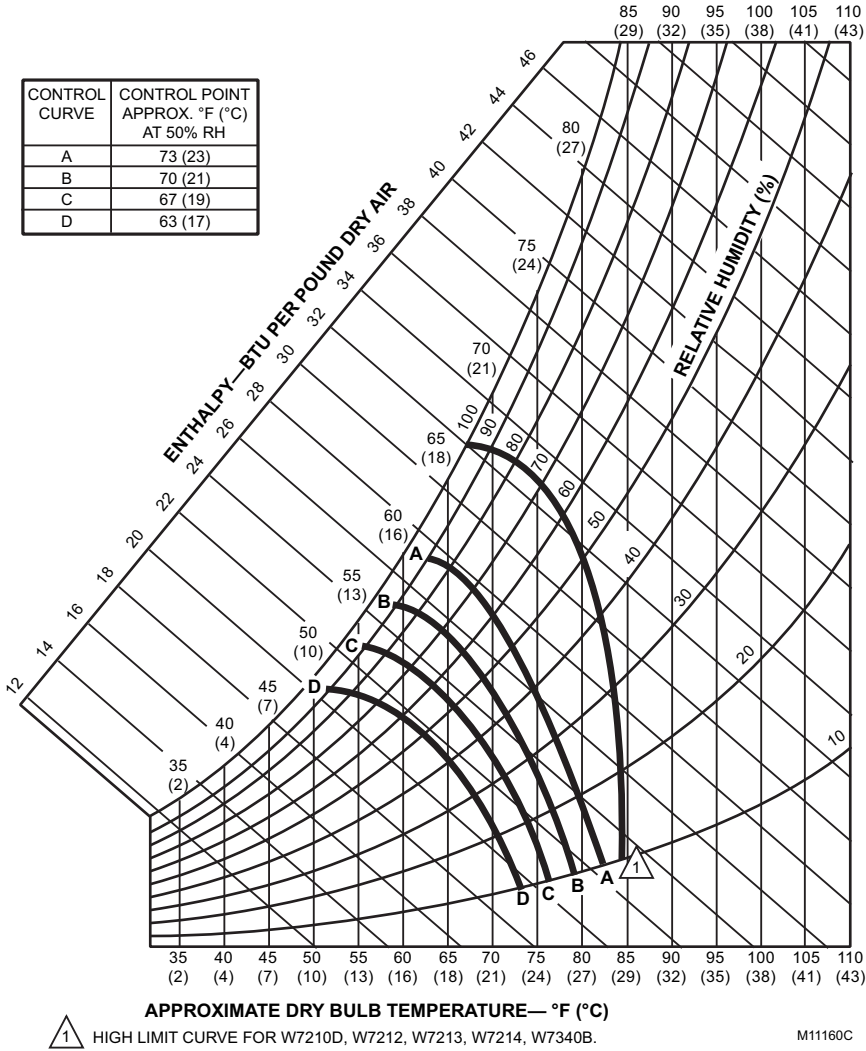

Fig. 5. Partial psychrometric chart with single C7400A Enthalpy Sensor and A,B,C, and D Logic Module performance Curves.

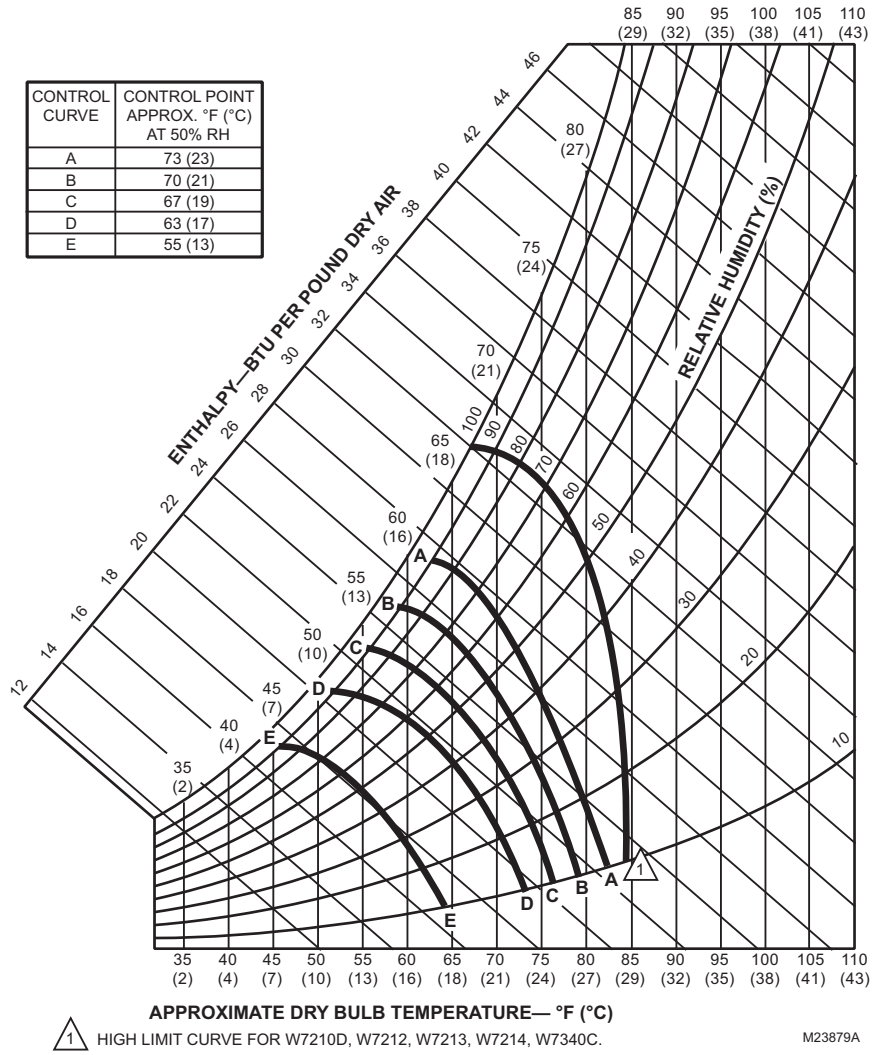

Fig. 6. Partial psychrometric chart with single C7400C enthalpy sensor and the A,B,C,D, and E logic module performance curves.

By using this Honeywell literature, you agree that Honeywell will have no liability for any damages arising out of your use or modification to, the literature. You will defend and indemnify Honeywell, its affiliates and subsidiaries, from and against any liability, cost, or damages, including attorneys' fees, arising out of, or resulting from, any modification to the literature by you.

Automation and Control Solutions

Honeywell International Inc.
1985 Douglas Drive North
Golden Valley, MN 55422
customer.honeywell.com

© U.S. Registered Trademark
© 2011 Honeywell International Inc.
63-2724—01 S.B. Rev. 12-11
Printed in United States

Honeywell