

C7363A Wall Particulate Matter Sensor

INSTALLATION INSTRUCTIONS

Before Installation

Read these installation instructions carefully before commissioning the PM Sensor. Failure to follow these instructions may result in product damage. Do not use in an explosive or hazardous environment, with combustible or flammable gases, as safety or emergency stop devices or in any other application where failure of the product could result in personal injury. Use electrostatic discharge precautions during installation and do not exceed the device ratings.

Mounting

The particulate matter transmitter mounts directly on a wall or onto an electrical wall box and should be mounted to a wall box five feet from the floor. Do not mount the sensor near doors, opening windows, supply air diffusers, or other known air disturbances. Avoid areas where the sensor is exposed to vibrations or rapid temperature changes.

The cover is hooked to the base at the top edge and must be removed from the bottom edge first. Use a small Phillips screwdriver to loosen the security screw as shown in Figure 1. (Complete removal of the screw is not required). Use a screw driver to carefully pry each bottom corner if necessary tip the cover away from the base as shown in Figure 1 and set it aside.

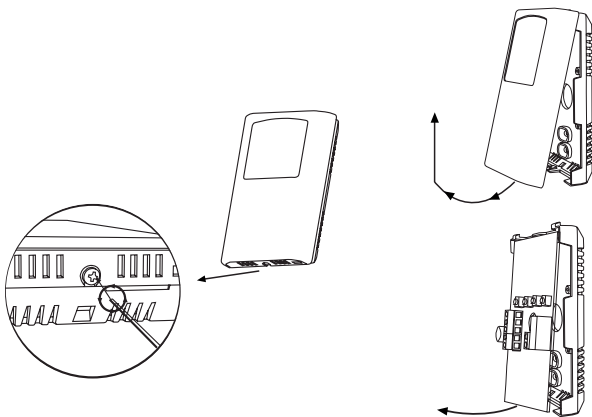

Fig. 1. Cover & PCB Removal

The PCB must be removed from the base to access the mounting holes. Follow usual anti-static procedures when handling the PCB. The PCB is removed by pressing the enclosure base to unsnap the latch near

the bottom edge, then the PCB can be lifted out of the base as shown in Figure 1.

Set the PCB aside until the base is mounted on the wall. For added protection, place the PCB in the supplied anti-static bag.

Mount the base by screwing to an electrical box or directly to the wall as shown in Figure 2. The mounting hole locations are shown in the Dimension drawings. After the base is screwed to an electrical box or the wall using the appropriate holes, remove the PCB from the anti-static bag, feed connection wires through center hole and place the top of PCB into the PCB holders on backplate and snap bottom of PCB into place as shown in Figure 2.

Make wire connections as per the Wiring Illustrations and install decorative cover by placing the top of the cover into the cover holder on the top of the backplate and snapping the bottom into place as shown in Figure 2. Tighten security screw with a Phillips screwdriver.

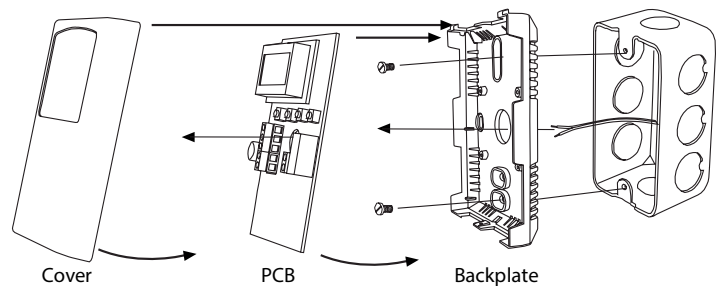

Fig. 2. Installation

Wiring

The particulate matter sensor has standard screw block connectors and easy wire access to facilitate wiring. It is recommended that shielded twisted pair wiring at least 22 AWG be used for all connections and that the device wires not be run in the same conduit with wiring used to supply inductive loads such as motors. Disconnect the power supply before making any connections to prevent electrical shock or equipment damage. Make all connections in accordance with national and local electrical codes.

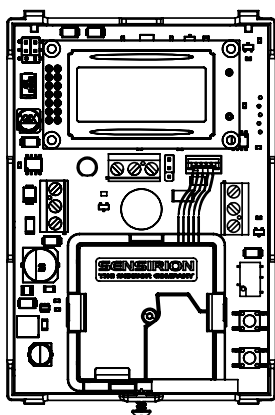

Fig. 4. PCB Layout

The device power (24 Vac/dc) is connected to the terminal marked PWR (POWER). This terminal is used for the positive dc voltage or the hot side of the ac voltage. The device is reverse voltage protected and as such will not operate if connected backwards.

The common of the power supply is connected to the terminal marked COM (COMMON). Note that this device has a half-wave type power supply which means the power supply common is the same as the output signal common. Therefore, several devices may be connected to one power supply and the output signals all share the same signal common. Use caution when grounding the secondary of an ac transformer or when wiring multiple devices to ensure that the circuit ground point is the same on all devices and the controller.

The analog output signal is available on the OUT (OUTPUT) terminal. This signal is jumper selectable for either voltage or 4-20 mA output signal type. See Figure 5. The voltage output signal defaults to 0-5 Vdc but may be changed to 0-10 Vdc via the menu. These options are clearly indicated on the device PCB. The analog output signal is typically connected directly to the Building Automation System (B.A.S.) and used as a control parameter or for logging purposes. Check the controller Analog Input type to determine the correct connection and signal type before applying power. The device generates the analog output signal (sourcing) and must not be connected to a powered input or device damage may occur.

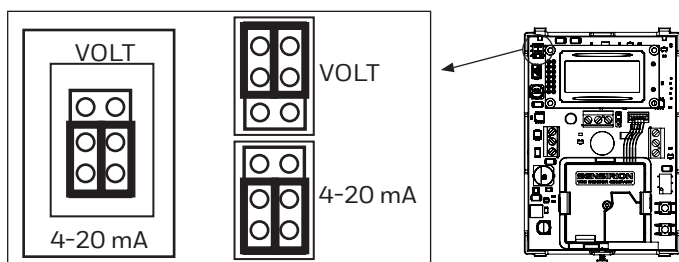

Fig. 5. Output Jumper

For voltage type output signal the device has a minimum load that it is able to drive, similarly for current type output signal the device has a maximum load that it is able to drive with a particular power supply voltage. Observe and follow these ratings in the Specification section or inaccurate reading may result.

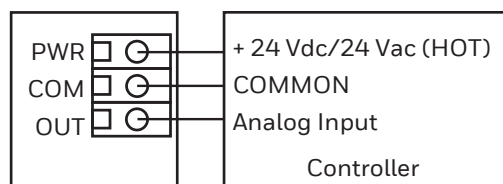

Fig. 6. Wiring

Operation - Start-Up

After applying power to the device, it will enter the start-up mode and the LCD will indicate the software version number, the PM range, the PM alarm setpoint (if applicable) and the analog output type for two seconds each.



Operation - Normal

During normal mode the device reads the PM sensor and calculates the Air Quality Index based on a 24 hour time average. The real time PM concentration value is displayed on the LCD and set as the output value for the analog output. The output value is updated once per second. The LCD may be configured via the menu to display either the PM value or the AQI.

On start-up when the first readings are obtained, the Air Quality reading for the device averages the concentration level as necessary until the required time base setting is reached. For example, if only 10 readings are available then the output value is calculated as the average of those 10 readings. The next output value will be an average of 11 readings. This short-averaging will continue until the unit has been running for 24 hours. Once 24 hours is reached then the AQI value will always be the average of readings over the past 24 hours.

Operation - Set-up

The Setup Menu has several items as shown below. To enter the menu, press and release the <MENU> key while in normal operation. This will enter the Setup Menu step 1, pressing the <MENU> key a second time advances to step 2. Each press of the <MENU>

WALL PARTICULATE MATTER SENSOR

key saves the selection and advances the menu item. The <ROLL> key is used to make changes to program variables by scrolling through the available options. If the Setup Menu is not active for 5 minutes (no key press), then the menu will exit and the device returns to normal operation.

<MENU> Press and hold to enter the setup menu. Once in menu release <MENU>.

1. Particulate Matter Range

*PM Range
PM10*

The default PM Range is PM10. Use <ROLL> to change the range as required to either PM1.0 PM2.5, PM4.0, or PM10.

<MENU> Press to advance to next menu item

2. Voltage Output Signal

*Output
0-5 Vdc*

Use <ROLL> to set the voltage output signal type to 0-5 or 0-10 Vdc. The factory default is 0-5 Vdc.

<MENU> Press to advance to next menu item

3. Analog Output

*Output
Direct*

The analog output defaults to Direct (4-20 mA, 0-5 Vdc or 0-10 Vdc). Use <ROLL> to change it to Reverse (20-4 mA, 5-0 Vdc or 10-0 Vdc) if required.

<MENU> Press to advance to next menu item

4. Analog Output Scale

*Scale
1000 ug*

The default analog output scale is 0-1000 ug/m³. The maximum value can be changed from 500 to 1000 (resolution 100) using <ROLL> if required. For example, the output can be 4-20 mA = 0-700 ug/m³.

<MENU> Press to advance to next menu item

5. Display Information

*Display
ug/m3*

Use <ROLL> to configure the display information as Mass Concentration in ug/m³ or as an Air Quality Index (0-500 AQI / GOOD, MODERATE, POOR). The display will change from ug/m³ to AQI.

<MENU> Press to advance to next menu item

6. Backlight

*Backlite
Auto*

The backlight operation defaults to Auto operation. It can be set to Off or On using <ROLL>. Auto means the LCD backlight only lights when a menu is accessed, off means it never lights and on means it is always on.

<MENU> Press to advance to next menu item

Dimensions

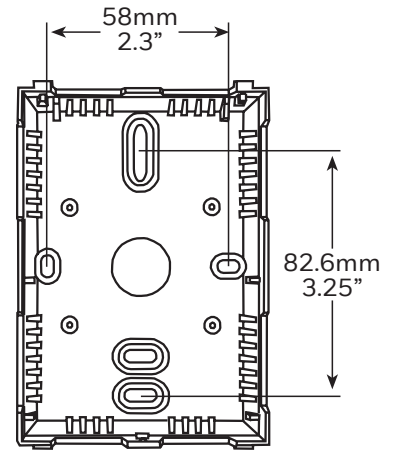
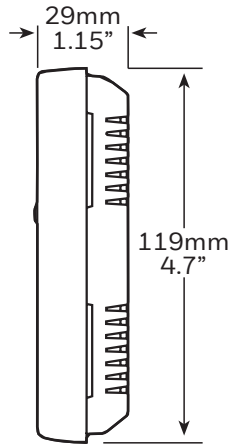
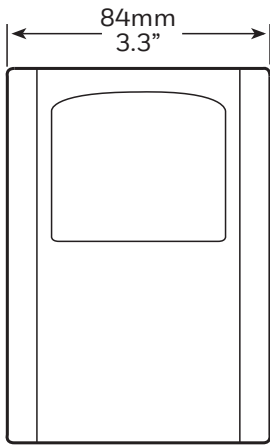

WEEE Directive 2012/19/EC Waste Electrical and Electronic Equipment directive

At the end of the product life dispose of the packaging and product in a corresponding recycling centre. Do not dispose of the unit with the usual domestic refuse. Do not burn the product.



WARNING: This product can expose you to chemicals which are known to the State of California to cause cancer/birth defects or other reproductive harm. For more information go to www.P65Warnings.ca.gov.

Honeywell Building Technologies

In the U.S.:
Honeywell
715 Peachtree Street NE
Atlanta, GA 30308
customer.honeywell.com

® U.S. Registered Trademark
© 2020 Honeywell International Inc.
Printed in Canada
31-00413-01

THE
FUTURE
IS
WHAT
WE
MAKE IT

Honeywell