

TB7200 Series Communicating Zone Thermostats

INSTALLATION INSTRUCTIONS

APPLICATION



**TB7200 Series
Thermostat**



**TB7200 Series
Thermostat with
Occupancy Sensor**

The TB7200 Series PI thermostat family is specifically designed for zoning applications. The TB7200 Series are communicating thermostats with models available in BACnet® MS/TP and ZigBee® wireless mesh protocols and can be easily integrated into a WEBS-AX building automation system based on the NiagaraAX® platform.

Typical applications include local hydronic reheat valve control and pressure dependent VAV with or without local reheat. Accurate temperature control is achieved due to the product's PI proportional control algorithm, which virtually eliminates temperature offset associated with traditional, differential-based thermostats. Models are available for 3 point floating and analog 0 to 10 Vdc control. In addition remote room sensing is available.

Thermostats equipped with an occupancy sensor cover provide advanced active occupancy logic, which will

automatically switch occupancy levels from Occupied to Stand-By and Unoccupied as required by local activity being present or not. This advanced occupancy functionality provides advantageous energy savings during occupied hours without sacrificing occupant comfort. All thermostats are PIR ready and can be ordered with or without Honeywell occupancy sensor. The occupancy sensor cover is available to order separately if a PIR is needed at a later time.

FEATURES

- Available in BACnet MS/TP and ZigBee wireless protocols
- Backlit LCD display with dedicated function menu keys for simple operation
- Fully integrated advanced occupancy functionality with a PIR cover provides energy savings opportunity on select models; all other models are PIR ready and can have an optional occupancy sensor cover added at any time
- Pre-configured sequences of operation means one model meets more application needs
- Password protection to minimize parameter tampering
- Four levels of keypad lockout to limit access to change user parameters such as setpoints, system mode, etc.
- Available in 24 Vac on/off, floating or 0-10 Vdc analog control to meet advanced applications requirements
- Three configurable inputs for monitoring and advanced functions
- SPST auxiliary output that can be used for lighting or reheat
- All wiring connections are made to removable terminal blocks simplifying installation



TB7200 Series Model Selection

Product Number	Description	Outputs	Occupancy Sensor ¹
BACnet Models			
TB7200C5014B	Modulating with Reheat	2 floating or on/off + 1 Aux	Ready
TB7200C5514B	Modulating with Reheat	2 floating or on/off + 1 Aux	Yes
TB7200F5014B	Modulating with Reheat	2 0-10Vdc + 1 Aux	Ready
TB7200F5514B	Modulating with Reheat	2 0-10Vdc + 1 Aux	Yes
Wireless Models			
TB7200C5014W	Modulating with Reheat	2 floating or on/off + 1 Aux	Ready
TB7200C5514W	Modulating with Reheat	2 floating or on/off + 1 Aux	Yes
TB7200F5014W	Modulating with Reheat	2 0-10Vdc + 1 Aux	Ready
TB7200F5514W	Modulating with Reheat	2 0-10Vdc + 1 Aux	Yes
Accessories			
TB-PIR-ZN	Zone Occupancy Sensor Cover		
TB-RA-1014	Wireless Remote Antenna Base		
TB-RP5000W	Wireless Repeater for TB7XXX Series Wireless Thermostats		
TBST-5014W	ZigBee Wireless Survey Toolkit		
TB-VWG-APP-1014	TB7XXX Series Wireless Communication Card		
TB-WALL-1014	Room Sensor 10K NTC Type 2		
TB-WALLOVR-1014	Room Sensor with Override 10K NTC Type 2		

¹ Thermostats ordered without an occupancy sensor cover can be retrofitted with the cover at a later time if required

More Information

We recommend downloading the appropriate integration reference document (wireless or BACnet) and if installing thermostats with occupancy sensor covers, then also downloading the PIR Application Guide before you begin installation. All documentation is available on <http://customer.honeywell.com>.

- BACnet Integration Manual for TB7200 and TB7300 Series Thermostats (Form No. 63-4524)
- Wireless Installation & Integration Reference Guide for TB7200, TB7300, and TB7600 Thermostats (Form No. 63-4522)
- PIR Application Guide for TB7200 and TB7300 Thermostats (Form number 63-4526)
- Sensors Product Overview Brochure (Form No. 63-9285) provides a complete listing of compatible sensors.

INSTALLATION AND WIRING

Mounting Location

- Do not install on an outside wall
- Must be installed away from any heat source
- Should not be installed near an air discharge grill
- Should not be mounted in direct sun light
- Nothing must restrain vertical air circulation to the thermostat
- Wall surface must be flat and clean

IMPORTANT

If replacing an old thermostat, label the wires before removal of the old thermostat.



CAUTION

- Electronic controls are static sensitive devices. Discharge yourself properly before manipulation and installing the thermostat.
- Short circuit or wrong wiring may permanently damage the thermostat or the equipment.
- Anti-short cycling can be set to 0 minutes for equipment that has an anti cycling timer. Do not set to 0 unless the equipment has internal anti-cycling timer or damage to equipment can occur.
- All TB7200 series thermostats are to be used only as operating controls. Whenever a control failure could lead to personal injury and/or loss of property, it becomes the responsibility of the user to add safety devices and/or alarm system to protect against such catastrophic failures.

Thermostat Installation

1. Open up by pulling on the bottom side of thermostat. (Fig. 1)
2. Remove wiring terminals.
3. Open the thermostat PCB to the left by pressing the PCB retaining tabs. (Fig. 2)
4. Pull cables 6 inches out of the wall.
5. Thread cable through the central hole of the base.
6. Align the base and mark the location of the two mounting holes on the wall. Install proper side of base up.
7. Install anchors in the wall.
8. Insert screws through the mounting holes on each side of the base and mount base on wall. (Fig. 2).
9. Gently swing back the circuit board back to the base and push on it until the tabs lock it in place.
10. Strip each wire 1/4 inch.
11. Wire the terminals for the desired application. See Table 1 for terminal descriptions and wiring diagrams.
12. Gently push back excess cable into hole.
13. Install wiring terminals in correct location (Fig. 3).
14. Reinstall the cover (top first).
15. Install security screw.

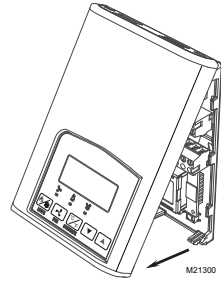

Fig. 1. Remove cover of thermostat

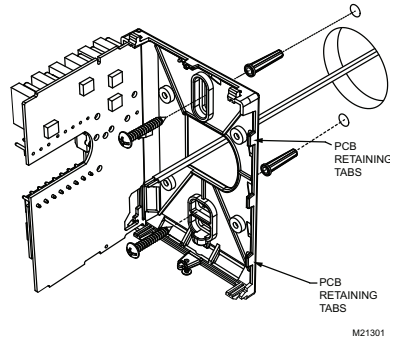

Fig. 2. Location of PCB retaining tabs and mounting screws

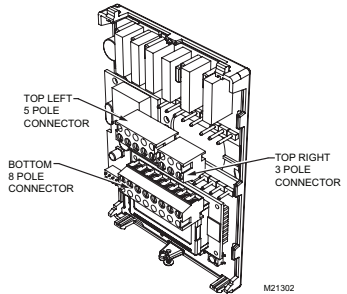

Fig. 3. Re-install terminal blocks

Thermostat Terminals

Table 1. Terminal identification

Terminal Description	TB7200C5x14(x) 1 or 2 floating outputs 1 or 2 on/off outputs	Terminal Description	TB7200F5x14(x) 1 or 2 analog outputs
4- 24 V~ Hot	24 V~ Hot	4- 24 V~ Hot	24 V~ Hot
5- 0 V~ Com	24 V~ Com	5- 0 V~ Com	24 V~ Com
6- Aux BO 5	BO 5-Aux	6- Aux BO 5	BO 5-Aux
7- Aux BO 5	BO 5-Aux	7- Aux BO 5	BO 5-Aux
8- BO 3 Open Heat	BO 3		
9- BO 4 Close Heat	BO 4	9- AO 2 Heat	AO 2
10- BO 1 Open Cool	BO 1	10- AO 1 Cool	AO 1
11- BO 2 Close Cool	BO 2	Not used Blank	Blank
12- BI 1	BI 1	12- BI 1	BI 1
13- RS	RS	13- RS	RS
14- Scdm	Scdm	14- Scdm	Scdm
15- BI 2	BI 2	15- BI 2	BI 2
16- UI 3 COS/COC /SS	UI 3	16- UI 3 COS/COC /SS	UI 3

For information on configuration options for the binary inputs (B1 and B2) and the universal input (U3) see Table 8. Configuration Parameters.

Sensor Wiring for all Thermostat Models

Remote mount temperature sensors use 10K NTC thermistor. A remote sensor can be used for:

- Various averaging combinations
- Optional occupancy led
- Optional override key

Table 2. Temperature vs. Resistance chart for 10 Kohm NTC thermistor
($R_{25^{\circ}\text{C}} = 10\text{K}\Omega \pm 3\%$, $B_{25/85^{\circ}\text{C}} = 3975\text{K} \pm 1.5\%$)

°C	°F	Kohm	°C	°F	Kohm	°C	°F	Kohm	°C	°F	Kohm	°C	°F	Kohm
-40	-40	324.3197	-20	-4	94.5149	0	32	32.1910	20	68	12.4601	40	104	5.3467
-35	-31	234.4009	-15	5	71.2430	5	41	25.1119	25	77	10.0000	45	113	4.3881
-30	-22	171.3474	-10	14	54.1988	10	50	19.7390	30	86	8.0694	50	122	3.6202
-25	-13	126.6109	-5	23	41.5956	15	59	15.6286	35	95	6.5499	55	131	3.0016

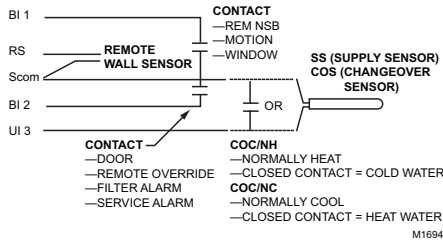
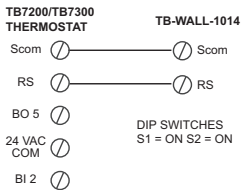
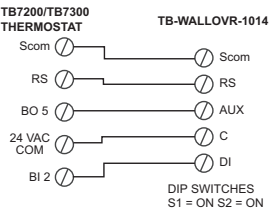

Fig. 4. Remote Inputs

If LED indicator is desired at the TB-WALL-OVR-1014:

1. Set the Aux Cont installer parameter (which controls BO5) to option 2, Auxiliary NC.
2. Install a jumper across the BO5 terminal and 24 Vac Hot.

REMOTE WIRING 1 SENSOR



M32847A

Fig. 5. Wiring example of single remote wall mounted room sensor

REMOTE WIRING 2 SENSORS

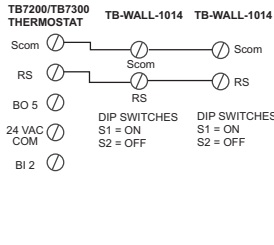
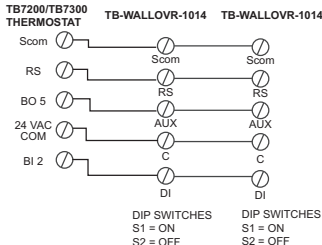
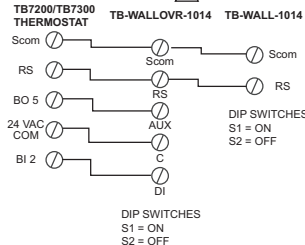

△ TB-WALL-1014 AND TB-WALLOVR-1014 CAN BE MIXED AND MATCHED
 TB-WALL-1014 AND TB-WALLOVR-1014 ARE TO BE WIRED IN PARALLELL
 ENSURE THE DIP SWITCH SETTINGS ARE CORRECT IN EACH REMOTE SENSOR

M32848A

Fig. 6. Wiring examples of two remote wall mounted room sensors for averaging applications

REMOTE WIRING 3 SENSORS

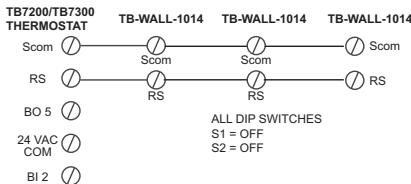
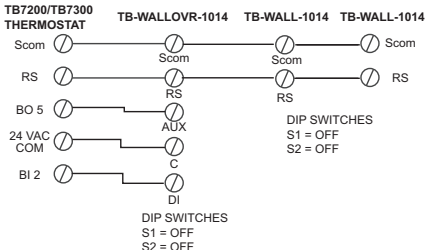

△ TB-WALL-1014 AND TB-WALLOVR-1014 CAN BE MIXED AND MATCHED
 TB-WALL-1014 AND TB-WALLOVR-1014 ARE TO BE WIRED IN PARALLELL
 ENSURE THE DIP SWITCH SETTINGS ARE CORRECT IN EACH REMOTE SENSOR

M32849A

Fig. 7. Wiring examples of three remote wall mounted room sensors for averaging applications

Wiring Auxiliary Inputs

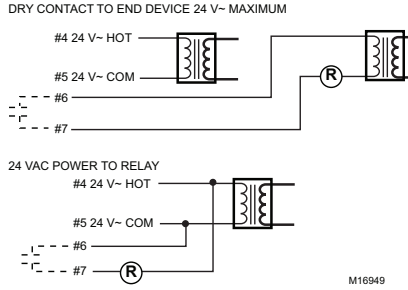
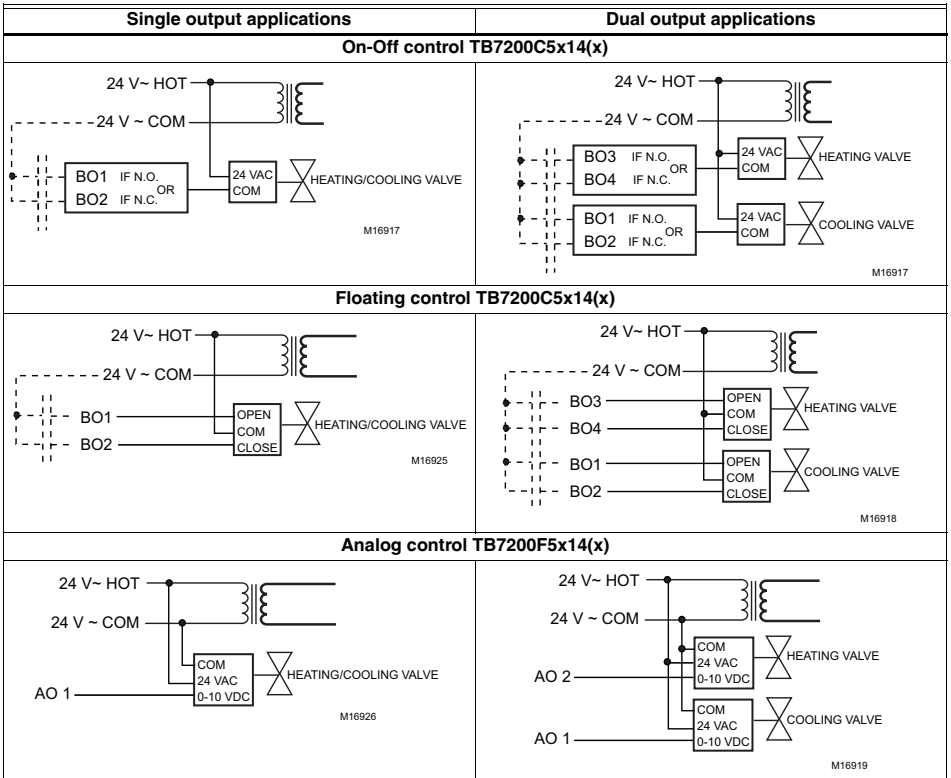
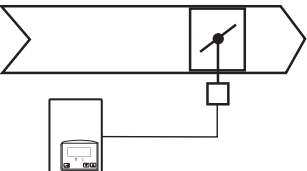
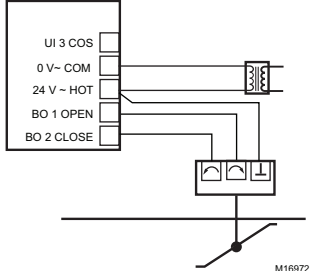
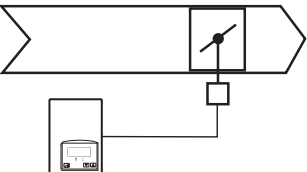
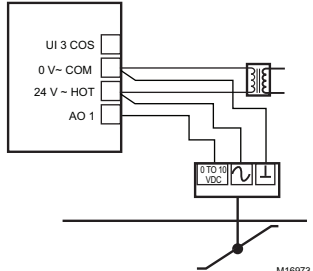
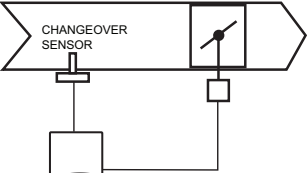
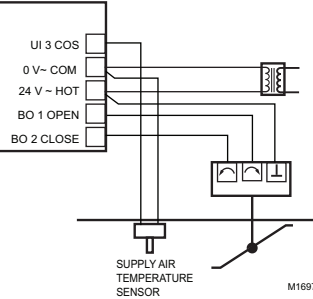
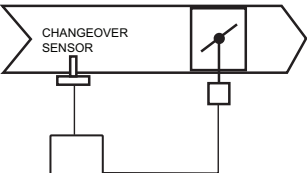
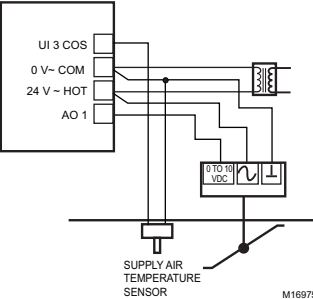

Fig. 8. Auxiliary Inputs

Wiring for Typical Valve Applications



Wiring for Typical Actuator Applications

Schematic	Wiring	Settings
Pressure dependent VAV cooling only: TB7200C5x14(x) floating actuator		
<p>Modulating floating VAV Actuator</p>  <p>ROOM TEMPERATURE CONTROL MINIMUM AND MAXIMUM POSITION ADJUSTED ON THE ACTUATOR</p> <p>M16965</p>	 <p>M16972</p>	<p>Mandatory</p> <ul style="list-style-type: none"> • Out1Conf = 2.0 • ContrlTyp = Floating • FL time = <i>as per actuator</i> • SeqOpera = 0 Cooling only
Pressure dependent VAV cooling only: TB7200F5x14(x) analog actuator		
<p>Analog VAV Actuator</p>  <p>ROOM TEMPERATURE CONTROL MINIMUM AND MAXIMUM POSITION ADJUSTED ON THE ACTUATOR</p> <p>M16965</p>	 <p>M16973</p>	<p>Mandatory</p> <ul style="list-style-type: none"> • Out1Conf = 2.0 • RA/DA = <i>as per actuator</i> • SeqOpera = 0 Cooling only
Pressure dependent VAV cooling/heating with changeover: TB7200C5x14(x) floating actuator		
<p>Modulating floating VAV Actuator</p>  <p>ROOM TEMPERATURE CONTROL MINIMUM AND MAXIMUM POSITION ADJUSTED ON THE ACTUATOR</p> <p>M16966</p>	 <p>M16974</p>	<p>Mandatory</p> <ul style="list-style-type: none"> • Out1Conf = 2.0 • ContrlTyp = Floating • FL time = <i>as per actuator</i> <p>If heat/cool auto-changeover with a local discharge air temperature sensor set:</p> <ul style="list-style-type: none"> • SeqOpera = 0 Cooling only • UI3 = COS
Pressure dependent VAV cooling/heating with changeover: TB7200F5x14(x) analog actuator		
<p>0 to 10 Vdc analog Actuator</p>  <p>ROOM TEMPERATURE CONTROL MINIMUM AND MAXIMUM POSITION ADJUSTED ON THE ACTUATOR</p> <p>M16966</p>	 <p>M16975</p>	<p>Mandatory</p> <ul style="list-style-type: none"> • Out1Conf = 2.0 • RA/DA = <i>as per actuator</i> <p>If heat/cool auto-changeover with a local discharge air temperature sensor set:</p> <ul style="list-style-type: none"> • SeqOpera = 0 Cooling only • UI3 = COS

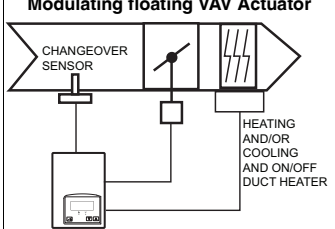
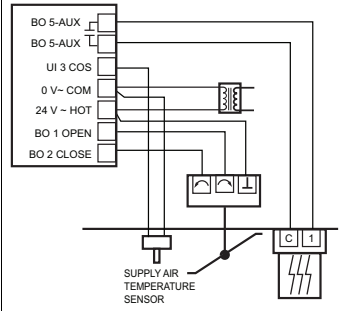
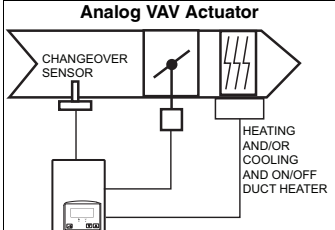
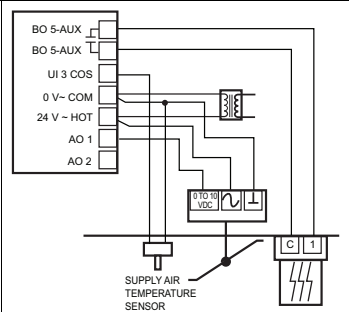
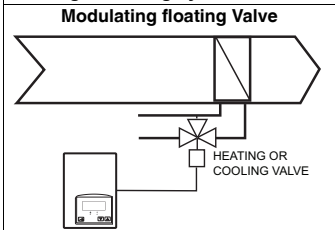
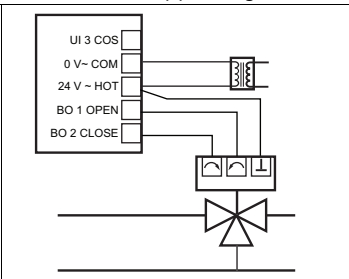
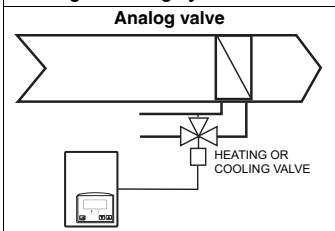
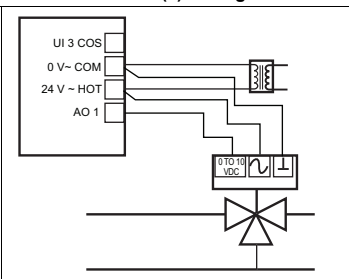
Schematic	Wiring	Settings
Pressure dependent VAV cooling/heating with changeover and reheat: TB7200C5x14(x) floating actuator		
<p>Modulating floating VAV Actuator</p>  <p>ROOM TEMPERATURE CONTROL MINIMUM AND MAXIMUM POSITION ADJUSTED ON THE ACTUATOR</p> <p>M16967</p>	 <p>M16976</p>	<p>Mandatory</p> <ul style="list-style-type: none"> • Out1Conf = 2.0 • CntrlTyp = Floating • FL time = as per actuator <p>If heat/cool auto-changeover with a local discharge air temperature sensor set:</p> <ul style="list-style-type: none"> • SeqOpera = 2 Cooling with Reheat • UI3 = COS
Pressure dependent VAV cooling/heating with changeover and reheat: TB7200F5x14(x) analog actuator		
<p>Analog VAV Actuator</p>  <p>ROOM TEMPERATURE CONTROL MINIMUM AND MAXIMUM POSITION ADJUSTED ON THE ACTUATOR</p> <p>M16967</p>	 <p>M16979</p>	<p>Mandatory</p> <ul style="list-style-type: none"> • Out1Conf = 2.0 • RA/DA = as per actuator <p>If heat/cool auto-changeover with a local discharge air temperature sensor set:</p> <ul style="list-style-type: none"> • SeqOpera = 2 Cooling with Reheat • UI3 = COS
Heating or cooling hydronic valve control: TB7200C5x14(x) floating actuator		
<p>Modulating floating Valve</p>  <p>ROOM TEMPERATURE CONTROL THERMOSTAT</p> <p>M16968</p>	 <p>M16977</p>	<p>Mandatory</p> <ul style="list-style-type: none"> • Out1Conf = 2.0 • CntrlTyp = Floating • FL time = as per actuator <p>If cooling only set:</p> <ul style="list-style-type: none"> • SeqOpera = 0 Cooling only <p>If heating only set:</p> <ul style="list-style-type: none"> • SeqOpera = 1 Heating only
Heating or cooling hydronic valve control: TB7200F5x14(x) analog actuator		
<p>Analog valve</p>  <p>ROOM TEMPERATURE CONTROL THERMOSTAT</p> <p>M16968</p>	 <p>M16978</p>	<p>Mandatory</p> <ul style="list-style-type: none"> • Out1Conf = 2.0 • RA/DA = as per actuator <p>If cooling only set:</p> <ul style="list-style-type: none"> • SeqOpera = 0 Cooling only <p>If heating only set:</p> <ul style="list-style-type: none"> • SeqOpera = 1 Heating only

Schematic	Wiring	Settings
Cooling/heating with changeover hydronic valve control: TB7200C5x14(x) floating actuator		
<p>Modulating floating Valve</p> <p>OPTIONAL WATER SUPPLY SENSOR</p> <p>ROOM TEMPERATURE CONTROL THERMOSTAT</p> <p>M16969</p>	<p>UI 3 COS</p> <p>0 V - COM</p> <p>24 V - HOT</p> <p>BO 1 OPEN</p> <p>BO 2 CLOSE</p> <p>SUPPLY AIR TEMPERATURE SENSOR</p> <p>M16980</p>	<p>Mandatory</p> <ul style="list-style-type: none"> • Out1Conf = 2.0 • CntrlTyp = Floating • FL time = <i>as per actuator</i> <p>If heat/cool auto-changeover with a local water temperature sensor set:</p> <ul style="list-style-type: none"> • SeqOpera = 0 Cooling only • UI3 = COS
Cooling/heating with changeover hydronic valve control: TB7200F5x14(x) analog actuator		
<p>Analog Valve</p> <p>OPTIONAL WATER SUPPLY SENSOR</p> <p>ROOM TEMPERATURE CONTROL THERMOSTAT</p> <p>M16969</p>	<p>UI 3 COS</p> <p>0 V - COM</p> <p>24 V - HOT</p> <p>AO 1</p> <p>SUPPLY AIR TEMPERATURE SENSOR</p> <p>M16981</p>	<p>Mandatory</p> <ul style="list-style-type: none"> • Out1Conf = 2.0 • RA/DA = <i>as per actuator</i> <p>If heat/cool auto-changeover with a local water temperature sensor set:</p> <ul style="list-style-type: none"> • SeqOpera = 0 Cooling only • UI3 = COS

THERMOSTAT USER INTERFACE

The thermostat features a two-line, eight-character display. There is a low level backlight level that is always active and can only be seen at night. To turn on the back light to high level, press any key on the front panel. The back lit display will return to low level when the thermostat is left unattended for 45 seconds.

When left unattended, the thermostat has an auto scrolling display that shows the actual status of the system. Use the **MenuScro** in the configuration menu to lockout the scrolling display and to only present the room temperature and conditional outdoor temperature to the user. With this option enabled, no local status is given on the system mode or occupancy.

Each item is scrolled one by one with the back lighting in low level mode. Pressing any key will cause the back light to come on to high level. When left unattended for 10 seconds after changes are made, the display will resume automatic status display scrolling.

Table 3. Sequence and possible display options for the auto-scroll display

Room Temp	>	System mode	>	Schedule status	>	Outdoor Temp*	>	Alarms
Room Temp x.x °C or °F		Sys mode auto		Occupied		Outdoor x.x °C or °F		Service
		Sys mode cool		Stand-By				Filter
		Sys mode heat		Unoccup				Window
		Sys mode off		Override				

* Network value only

Outdoor air temperature

Display is only enabled when outdoor air temperature network variable is received.

Occupancy Status

Occupied, Stand-By, Unoccupied and Override status are displayed on the scrolling display.

Alarms

- If alarms are detected, they will automatically be displayed at the end of the status display scroll.
- During an alarm message display, the back lit screen will light up at the same time as the message and shut off during the rest of the status display.
- Two alarms maximum can appear at any given time. The priority for the alarms is as follows:

Service	Indicates that there is a service alarm as per one of the programmable binary input (BI2)
Filter	Indicates that the filters are dirty as per one of the programmable binary input (BI2)
Window	Indicates that the outside window or door is opened and that the thermostat has cancelled any cooling or heating action (BI1)

STATUS LED'S

Two status LED's on the thermostat cover are used to indicate a call for heat or a call for cooling as shown in Fig. 9.

Zoning models

- When heating and reheat is ON, the HEAT LED will illuminate.
- When cooling is ON, the COOL LED will illuminate.

User Control Options

Unoccupied Mode Override

An Override can be made during an unoccupied period. If the Override option is enabled in the **Lockout** parameter, pressing the middle override button will resume occupied setpoints for a time specified by parameter **ToccTime**.

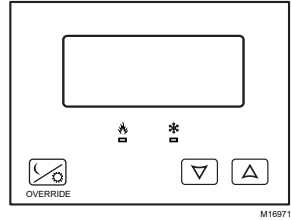

Fig. 9. Zoning model thermostat buttons and display

Table 4. Keypad interface

Override	An Override can be made during an Unoccupied period. If the Override option is enabled in the Lockout parameter pressing the override key will resume occupied setpoints for a time specified by parameter ToccTime
Down	Adjust the setpoints down <ul style="list-style-type: none"> • In cooling mode only the cooling setpoint displayed, • In heating mode only the heating setpoint displayed • In auto mode (see below)
Up	Adjust the setpoints up <ul style="list-style-type: none"> • In cooling mode only the cooling setpoint displayed, • In heating mode only the heating setpoint displayed • In auto mode (see below)

- Any setpoint change can be permanent or temporary based on parameter **Set Type** (setpoint type)
- Any setpoint written through the network, will be permanent and cancel any active temporary setpoints
- Lockouts of access to certain functions is made with the parameter (**Lockout**)

Table 5. Occupied setpoint adjustments

Cooling mode	Heating mode	Off mode	Auto Mode
Cool XX.X °F or °C	Heat XX.X °F or °C	No access to setpoint	<ul style="list-style-type: none"> • Setpoint presented to user is the setpoint from the last action taken by the thermostat or the one currently in use. • Both heating and cooling setpoint are changed simultaneously while respecting the minimum configured deadband
			Cool XX.X°F or °C and Heat XX.X°F or °C Both heating and cooling setpoints are change simultaneously

Unoccupied setpoints adjustments

Unoccupied setpoints cannot be set or changed by the user in the display status. Changes to unoccupied setpoints are done using the parameters **Unocc HT** and **Unocc CL** or through the WEBStation-AX.

System mode functions

NOTE: Default system mode of operation is dependent on sequence of operation selected

- **Default mode** is **bold**, as shown in Table 6, when the sequence of operation parameter is changed.
- *The available mode can only be changed through the network since there is no local mode access.*

Table 6. System mode functions

Sequence selected	Mode Menu
0 = Cooling only	Off - Cool
1 = Heating only	Off - Heat
2 = Cooling with reheat	Off - Auto - Heat - Cool
3 = Heating with reheat	Off - Heat
4 = Cooling and Heating (2 modulating outputs)	Off - Auto - Heat - Cool
5 = Cooling/Heating (2 modulating outputs) with reheat	Off - Auto - Heat - Cool

INSTALLER CONFIGURATION PARAMETER MENU

This section describes the parameters available for TB7200 Series thermostat configuration. The TB7200 Series can be programmed at the thermostat or through WEBStation-AX, with the following exception: Wireless models must have the **Com Addr**, **PAN ID**, and **Channel** set at the thermostat before adding to the wireless network or doing any programming in WEBStation-AX.

To program the thermostat through WEBStation-AX, refer to the BACnet Integration Reference Guide for BACnet models (Form No. 63-4524) or the Wireless Installation and Integration Reference Guide for TB7200, TB7300, TB7600 Thermostats (Form No. 63-4522) for wireless models.

Local configuration:

1. To enter configuration, press and hold the Override button for 8 seconds
2. If a password lockout is active, "*Password*" is prompted. Enter password value using the "*up*" and "*down*" arrows and press the Override button again to gain access to all configuration properties of the thermostat. A wrong password entered will prevent local access to the configuration menu.
3. Press the Override button repetitively to scroll between all the available parameters
4. Use the up and down key to change the parameter to the desired value.
5. To acknowledge and save the new value, press the Override button again.
6. The next listed parameter is now displayed.

Table 7. Configuration interface

Override	Press and hold for 8 seconds to enter the configuration mode. Pressing repetitively will scroll all available parameters one by one
Down	Adjust parameter value down
Up	Adjust parameter value up

Table 8. Configuration Parameters

Configuration parameters	Default value	Significance and adjustments
PswrdSet	Configuration parameters menu access password Default value = 0 Range is: 0 to 1000	This parameter sets a protective access password to prevent unauthorized access to the configuration menu parameters. A default value of "0" will not prompt a password or lock the access to the configuration menu.
Com Addr	Thermostat networking address Default value = 254 Range is: 0 to 254	If the thermostat is installed as a stand-alone unit, this parameter will not be used or displayed For BACnet models valid range to use is from 0 to 127. Default value of 254 disables BACnet communication for the thermostat. For wireless models valid range is 0 to 254 with a maximum of 30 thermostats per WEB-2xx controller and 50 thermostats per WEB-6xx/-7xx controller.
PAN ID	Personal Area Network Identification Default value = 0 Range is: 0 to 500	Conditional parameter to wireless models (TB7200X5x14W) This parameter will only appear on wireless thermostats. If the thermostat is BACnet, this parameter will not be used or displayed This parameter (Personal Area Network Identification) is used to link specific thermostats to a single specific WEBs controller with a wireless communication card (TB-VWG-APP-1014). For every thermostat reporting to a WEBs controller and wireless communication card (maximum of 30 thermostats per WEB-2xx controller and 50 thermostats per WEB-6xx/-7xx controller) be sure you set the SAME PAN ID value both at the wireless communication card and the thermostat(s). The default value of 0 is NOT a valid PAN ID. The valid range of available PAN ID is from 1 to 500
Channel	Channel selection Default value = 10 Set to: 15 or 25 Range is: 10 to 26	Conditional parameter to wireless models (TB7200X5x14W) This parameter will only appear when a wireless network adapter is present. If the thermostat is installed as a stand-alone unit or is a BACnet model, this parameter will not be used or displayed This parameter (Channel) is used to link specific thermostats to a specific WEBs controller with a wireless communication card. For every thermostat reporting to a gateway (maximum of 30 thermostats per WEB-2xx controller and 50 thermostats per WEB-6xx/-7xx controller) be sure you set the SAME channel value both at the wireless communication card and the thermostat(s). Honeywell recommends using only the channels 15 (2425 MHz) or 25 (2575 MHz). The default value of 10 is NOT a valid channel. Although the valid range of available channels is from 11 to 26 use only channel 15 or 25 to avoid interference with other wireless devices.
Get From	Get From another thermostat configuration utility Default value = 255 Range is: 0 to 254	Conditional parameter to wireless models (TB7200X5x14W) This parameter is only available for wireless thermostats. This parameter lets you to copy the configuration parameter settings from a like Honeywell TB7200 thermostat. To use this command, the thermostat you want to copy parameters from must be on the wireless network with a network address (Com addr) and must be the same model number as the thermostat you want to copy to. On the thermostat you want to copy parameters to, enter the network address (Com addr) of the thermostat you want to copy parameters from. This process can be completed locally at the thermostat or using the WEBStation-AX. If the parameters copy successfully, the Get From address returns to 255 . If the parameters do not copy successfully, 254 is displayed. If the copy was not successful, verify the following: <ul style="list-style-type: none"> • The thermostat to be copied is the same model as the one being copied to. • The thermostat to be copied is on the network. • The correct network address (Com addr) value for the thermostat to be copied was entered. Leaving the Get From parameter value at 255 means that configuration parameters will be set manually.

Table 8. Configuration Parameters (Continued)

Configuration parameters	Default value	Significance and adjustments
B11	Binary input no.1 configuration Default value = None	<p>None - No function will be associated with the input</p> <p>Rem NSB - remote NSB timer clock input. The scheduling will now be set as per the binary input. It provides low cost setback operation via a dry contact</p> <ul style="list-style-type: none"> • Contact opened = Occupied • Contact closed = Unoccupied <p>Motion NO or Motion NC - Advanced PIR occupancy functions using a Normally Open (NO) or Normally Closed (NC) remote PIR motion sensor. Occupancy mode is now set as per applied PIR function and configuration.</p> <p>Application information is available in the PIR Application Guide for TB7200 Series Thermostats (Form No. 63-4526). This document provides installers and system designers with detailed examples on applications, parameter configuration, sequence of operations, troubleshooting and diagnostic help required for proper use of occupancy sensor models.</p> <p>Window EMS - Forces the system to disable any current heating or cooling action by the thermostat. The mode stays the same and the current setpoints are the same Occupied setpoints. Only the outputs are disabled. There is a Door/Window alarm displayed on the thermostat to indicate to the local tenant that the door/window needs to be closed for cooling or heating to resume.</p> <p>NOTE: These settings will disable the local override function on the thermostat.</p>
B12	Binary input no.2 configuration Default value = None	<p>(None): No function will be associated with the input</p> <p>(Door Dry) Door contact and Motion detector: This configuration is only functional if binary input #1 is set to Motion N.O. or Motion N.C. or a PIR accessory cover is used.</p> <p>With this sequence enabled, the occupancy is now dictated through those 2 inputs. Any motion detected will set the zone to occupied status. The zone will remain permanently in occupied mode until the door contact switch opens momentarily. The thermostat will then go in stand-by mode. If more movements are detected, the occupied mode will resume. While the door is opened, any movements detected by the remote PIR sensor or the PIR accessory cover will be ignored. Use a Normally Closed contact switching device.</p> <ul style="list-style-type: none"> • Contact opened = Door opened • Contact closed = Door closed <p>(RemOVR): temporary occupancy remote override contact. This function disables the central button override function on the thermostat. The override function is now controlled by a manual remote momentarily closed contact. When configured in this mode, the input operates in a toggle mode.</p> <p>It is now possible to toggle between unoccupied and occupied setpoints for the amount of time set by parameter (TOccTime) temporary occupancy time.</p> <p>(Filter): a backlit flashing Filter alarm will be displayed on the thermostat LCD screen when the input is energized. It can be tied to a differential pressure switch that monitor filters</p> <ul style="list-style-type: none"> • Contact opened = No alarm • Contact closed = Alarm displayed <p>(Service): a backlit flashing Service alarm will be displayed on the thermostat LCD screen when the input is energized. It can be tied in to the AC unit control card, which provides an alarm in case of malfunction.</p> <ul style="list-style-type: none"> • Contact opened = No alarm • Contact closed = Alarm displayed

Table 8. Configuration Parameters (Continued)

Configuration parameters	Default value	Significance and adjustments																					
UI3	Universal input no.3 configuration Default value = None	(None): No function will be associated with the input (COC/NH) Change over dry contact. Normally Heat: Used when both heating and cooling are controlled from the same thermostat output. Contact closes when cold air/water is present. Only used and valid if system parameter (Out1Conf) is set at 2.0 (COC/NC) Change over dry contact. Normally Cool: Used when both heating and cooling are controlled from the same thermostat output. Contact closes when hot air/water is present. Only used and valid if system parameter (Out1Conf) is set at 2.0 (COS) Change over analog sensor: Used where heating and cooling are controlled from the same output. Temperature in duct/pipe determines control mode (heat/cool). Only used and valid if system parameter (Out1Conf) is set at 2.0 (SS) Supply air sensor monitoring: Used for supply air temperature monitoring. Only used for network reporting of the supply air temperature. Has no internal function in the thermostat																					
MenuScro	Menu scroll Default value = On = Scroll active	Removes the scrolling display and only presents the room temperature to the user. With this option enabled, no status is given of mode, schedule and outdoor temperature. Outdoor temperature only displays if a network variable is received. On = Scroll active Off = Scroll not active																					
C or F	Sets the display scale of the thermostat Default value = °F	°F for Fahrenheit scale °C for Celsius scale																					
Lockout	Keypad lockout levels. Default value = 0 No lock	See Table 9 for Lockout level details																					
Table 9. Keypad Lockout Levels																							
<table border="1" style="width: 100%; border-collapse: collapse;"> <thead> <tr> <th style="width: 15%;">Level</th> <th style="width: 55%;">Occupied Temperature Setpoints</th> <th style="width: 30%;">Unoccupied Override</th> </tr> </thead> <tbody> <tr> <td style="text-align: center;">0</td> <td>Yes access</td> <td>Yes access</td> </tr> <tr> <td style="text-align: center;">1</td> <td>Yes access</td> <td>No access</td> </tr> <tr> <td style="text-align: center;">2</td> <td colspan="2"><i>Level not used</i></td> </tr> <tr> <td style="text-align: center;">3</td> <td colspan="2"><i>Level not used</i></td> </tr> <tr> <td style="text-align: center;">4</td> <td>No access</td> <td>Yes access</td> </tr> <tr> <td style="text-align: center;">5</td> <td>No access</td> <td>No access</td> </tr> </tbody> </table>			Level	Occupied Temperature Setpoints	Unoccupied Override	0	Yes access	Yes access	1	Yes access	No access	2	<i>Level not used</i>		3	<i>Level not used</i>		4	No access	Yes access	5	No access	No access
Level	Occupied Temperature Setpoints	Unoccupied Override																					
0	Yes access	Yes access																					
1	Yes access	No access																					
2	<i>Level not used</i>																						
3	<i>Level not used</i>																						
4	No access	Yes access																					
5	No access	No access																					
Out1Conf	Output # 1 configuration Default value = 4.0 (2 control outputs, no changeover)	Defines the type of operation needed for Output #1 (BO1 and BO2) 2.0, will limit the number of sequences of operation available from 0 to 3 Will enable heat/cool operation from the same output (refer to wiring diagram) 4.0, can access all the sequences of operation from 0 to 5 Will enable heat/cool operation from different output (refer to wiring diagram)																					
CntrlTyp	Control type for Triac models Default value = Floating	Defines the type of control output for the type of valves installed TB7200C5014x only On/Off is for normally opened or normally closed 24 Vac 2 position valves Floating is for modulating 3 wires control of 24 Vac floating valves																					

Table 8. Configuration Parameters (Continued)

Configuration parameters	Default value	Significance and adjustments
SeqOpera	Sequence of operation Default value = Sequence #1	See Table 10 for SeqOpera level details
Table 10. Sequence of Operation		
	Sequence	Single output application (Out1Conf) = 2.0
		Dual output application (Out1Conf) = 4.0
	0 = Cooling Only	Yes access
	1 = Heating only	Yes access
	2 = Cooling with Reheat	Yes access
	3 = Heating with Reheat	Yes access
	4 = Cool and Heat, 2 outputs	No access
	5 = Cool and Heat, 2 outputs with Reheat	No access
	For single output applications, the system access is also limited if UI3 is configured for local change-over COS, COC/NC or COC/NC.	
St-By TM	Stand-by Timer value Default = 0.5 hours	Time delay between the moment where the PIR cover detected the last movement in the area and the time which the thermostat stand-by mode and setpoints become active. Range is: 0.5 to 24.0 hours in 0.5 hr increments
Unocc TM	Unoccupied Timer value Default = 0.0 hours	Time delay between the moment where the thermostat toggles to stand-by mode and the time which the thermostat unoccupied mode and setpoints become active. The factory value or 0.0 hours : Setting this parameter to its default value of 0.0 hours disables the unoccupied timer. This prevents the thermostat from drifting from stand-by mode to unoccupied mode when PIR functions are used Range is: 0.0 to 24.0 hours in 0.5 hr increments
St-By HT	Stand-by heating setpoint Default value = 69 F	The value of this parameter should reside between the occupied and unoccupied heating setpoints. Ensure that the difference between the stand-by and occupied value can be recovered in a timely fashion when movement is detected in the zone. Stand-by heating setpoint range is: 40 to 90 F (4.5 to 32.0 C)
St-By CL	Stand-by cooling setpoint limit Default value = 78 F	The value of this parameter should reside between the occupied and unoccupied cooling setpoints. Ensure that the difference between the stand-by and occupied value can be recovered in a timely fashion when movement is detected in the zone. Stand-by cooling setpoint range is: 54 to 100 F (12.0 to 37.5 C)
Unocc HT	Unoccupied heating setpoint Default value = 62 F	Heating setpoint range is: 40 to 90 F (4.5 to 32.0 C)
Unocc CL	Unoccupied cooling setpoint limit Default value = 80 F	Cooling setpoint range is: 54 to 100 F (12.0 to 37.5 C)
Heat max	Maximum heating setpoint limit Default value = 90 F (32 C)	Maximum occupied and unoccupied heating setpoint adjustment. Heating setpoint range is: 40 to 90 F (4.5 to 32.0 C)
Cool min	Minimum cooling setpoint limit Default value = 54 F (12 C)	Minimum occupied and unoccupied cooling setpoint adjustment. Cooling setpoint range is: 54 to 100 F (12.0 to 37.5 C)

Table 8. Configuration Parameters (Continued)

Configuration parameters	Default value	Significance and adjustments																											
Pband	Proportional band setting Default value = 3	<p>Adjust the proportional band used by the thermostat PI control loop.</p> <p> CAUTION Note that the default value of 3.0 F (1.2 C) gives satisfactory operation in most normal installation cases. The use of a superior proportional band different than the factory one is normally warranted in applications where the thermostat location is problematic and leads to unwanted cycling of the unit. A typical example is a wall mounted unit where the thermostat is installed between the return and supply air feeds and is directly influenced by the supply air stream of the unit.</p> <table border="1" data-bbox="523 459 908 711"> <thead> <tr> <th>Value</th> <th>F scale P band</th> <th>C scale P band</th> </tr> </thead> <tbody> <tr> <td>3</td> <td>3 F</td> <td>1.7 C</td> </tr> <tr> <td>4</td> <td>4 F</td> <td>2.2 C</td> </tr> <tr> <td>5</td> <td>5 F</td> <td>2.8 C</td> </tr> <tr> <td>6</td> <td>6 F</td> <td>3.3 C</td> </tr> <tr> <td>7</td> <td>7 F</td> <td>3.9 C</td> </tr> <tr> <td>8</td> <td>8 F</td> <td>4.4 C</td> </tr> <tr> <td>9</td> <td>9 F</td> <td>5.0 C</td> </tr> <tr> <td>10</td> <td>10 F</td> <td>5.6 C</td> </tr> </tbody> </table>	Value	F scale P band	C scale P band	3	3 F	1.7 C	4	4 F	2.2 C	5	5 F	2.8 C	6	6 F	3.3 C	7	7 F	3.9 C	8	8 F	4.4 C	9	9 F	5.0 C	10	10 F	5.6 C
Value	F scale P band	C scale P band																											
3	3 F	1.7 C																											
4	4 F	2.2 C																											
5	5 F	2.8 C																											
6	6 F	3.3 C																											
7	7 F	3.9 C																											
8	8 F	4.4 C																											
9	9 F	5.0 C																											
10	10 F	5.6 C																											
Set Type	Temporary setpoint enable Default value = Permment Enables temporary setpoints feature to any change of occupied or unoccupied setpoint.	<p>Temporar: (temporary) Local changes to the heating or cooling setpoints by the user are temporary. They will remain effective for the duration specified in the parameter ToccTime. Setpoints will revert back to their default value after internal timer ToccTime expires. To change setpoints permanently, revert parameter to No or write setpoints through the network. Any setpoints written through the network will be permanent ones and saved to EEPROM.</p> <p>Permment: (permanent) Any change of occupied or unoccupied setpoints through the keypad by the user are permanent and saved to and EEPROM</p>																											
TOccTime	Temporary occupancy time Default value = 2 hours	<p>Temporary occupancy time with occupied mode setpoints when override function is enabled</p> <p>When the thermostat is in unoccupied mode, function is enabled with either the menu or BI1 or BI2 configured as remote override input. 0,1, 2, 3, 4, 5, 6, 7, 8, 9, 10, and up to 24 hours</p>																											
Deadband	Minimum deadband Default value = 2.0 F (1.0 C)	<p>Minimum deadband value between the heating and cooling setpoints. If modified, it will be applied only when any of the setpoints are modified. 2, 3, 4 or 5 F, 1.0 F increments (1.0 to 2.5 C, 0.5 C increments)</p>																											
Cal RS	Room air temperature sensor calibration Default value = 0.0 F or C	<p>Offset that can be added/subtracted to actual displayed room temperature ± 5.0 F, 1.0 F increments (± 2.5 C, 0.5 C increments)</p>																											

Table 8. Configuration Parameters (Continued)

Configuration parameters	Default value	Significance and adjustments
Aux cont	Auxiliary contact function and configuration Default value = 0 Not Used	<p>0 Aux contact function used for reheat. <i>IF SEQUENCE IS SET TO REHEAT THROUGH NETWORK OR LOCAL</i>, Ignore this parameter.</p> <p>The output will directly follow the occupancy of the thermostat 1 Auxiliary NO, Occ or St-By = Contact Closed/Unoccupied = Contact Opened 2 Auxiliary NC, Occ or St-By = Contact Opened/Unoccupied = Contact Closed</p> <p>Output to follow directly main occupancy and Fan on command Typically used for 2 position fresh air damper applications. 3 Auxiliary NO, Occ or St-By and Fan On = Contact Closed/Unoccupied and Fan On or Off = Contact Opened 4 Auxiliary NC, Occ or St-By and Fan On = Contact Opened/Unoccupied and Fan On or Off = Contact Closed</p> <p>Output to follow secondary network occupancy command 5 Auxiliary on/off control through auxiliary network command. The output can be commanded through the network for any required auxiliary functions through a separate and dedicated network variable.</p>
FL time	Floating actuator timing Default value = 1.5 minutes	TB7200C5x14(x) models only Maximum stroke time of floating valve actuator. 0.5 to 9.0 in 0.5 minutes increment
cph	On/Off devices cycles per hour Default value = 4 cph	TB7200C5x14(x) models only Will set the maximum number cycles per hour under normal control operation. It represents the maximum number of cycles that the equipment will turn ON and OFF in one hour. Note that a higher cph will represent a higher accuracy of control at the expense of wearing mechanical components faster. 3, 4, 5, 6, 7 and 8 cph
RA/DA	Reverse acting or Direct acting signal for analog output signals Default value = DA signal	TB72xxF5x14(x) models only Changes the action of the analog outputs on the analog models. DA = Direct acting - 0 to 100 % = 0 to 10 Vdc RA = Reverse acting - 0 to 10 % - 10 to 0 Vdc
Reheat	Sets the time base for the reheat output if used Default value = 0= 15 minute	Sets the reheat output time base Valid only if reheat sequences are enabled 0 = 15 minutes 1 = 10 seconds for Solid state relays
UI3 dis	Display supply or changeover temperature	Used as diagnostic/service help to troubleshoot and diagnose sensor operation Only when UI 3 is configured as an analog input (SS or COS)

SPECIFICATIONS

Network Protocol: Models available in BACnet MS/TP or ZigBee wireless mesh

WEBS-AX Controllers: Compatible with WEB-2xx, WEB-6xx, and WEB-7xx

Platform:

- WEB-2xx and WEB-6xx - WEBStation-AX 3.0 or later
- WEB-7xx - WEBStation-AX 3.5 or later

Thermostat power requirements: 19-30 Vac 50 or 60 Hz; 2 VA Class 2

Operating conditions:

- 32 F to 122 F (0 C to 50 C)
- 0% to 95% R.H. non-condensing

Storage conditions:

- 22 F to 122 F (-30 C to 50 C)
- 0% to 95% R.H. non-condensing

Temperature sensor: 10 K NTC thermistor on board

Temperature sensor resolution: ± 0.2 F (± 0.1 C)

Temperature control accuracy: ± 0.9 F (± 0.5 C) @ 70 F (21 C) typical calibrated

Remote Sensor Input: 10K NTC

Occ. Stand-By and Unocc cooling setpoint range: 54 to 100 F (12.0 to 37.5 C)

Occ. Stand-By and Unocc heating setpoint range: 40 F to 90 F (4.5 C to 32 C)

Room and outdoor air temperature display range -40 F to 122 F (-40 C to 50 C)

Proportional band for room temperature control: Cooling and Heating: 3.2 F (1.8 C)

Binary inputs: Dry contact across terminal BI1, BI2 and UI3 to Scom

Contact output rating:

- Triac output: 30 Vac, 1 Amp. Maximum, 3 Amp in-rush
- Analogue: 0 to 10 Vdc into 2K Ω resistance min.

Wire gauge 18 gauge maximum, 22 gauge recommended

Dimensions: See Fig. 10

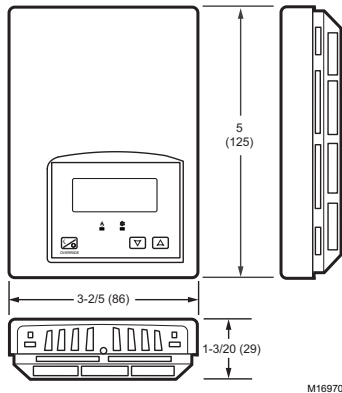

Fig. 10. Thermostat dimensions in inches (mm)

Approximate shipping weight: 0.75 lb (0.34 kg)

Agency Approvals all models:

UL: UL 873 (US) and CSA C22.2 No. 24 (Canada), File E27734 with CCN XAPX (US) and XAPX7 (Canada)

Industry Canada: ICES-003 (Canada)

C-Tick: EN55022:2006, IEC 61326-1:2005.

Agency Approvals all models

FCC: Compliant to CFR 47, Part 15, Subpart B, Class A (US)

CE: EMC Directive 89/336/EEC (Europe Union)

Agency Approvals wireless models

FCC: Compliant to: Part 15, Subpart C This device complies with part 15 of the FCC rules. Operation is subject to the following two conditions:(1) this device may not cause harmful interference, and (2) this device must accept any interference received, including interference that may cause undesired operation.

Agency Approval BACnet models

BTL

IMPORTANT

All TB7200 series controls are for use as operating controls only and are not safety devices. These instruments have undergone rigorous tests and verifications prior to shipment to ensure proper and reliable operation in the field. Whenever a control failure could lead to personal injury and/or loss of property, it becomes the responsibility of the user/installer/electrical system designer to incorporate safety devices (such as relays, flow switch, thermal protections, etc.) and/or alarm system to protect the entire system against such catastrophic failures. Tampering of the devices or miss application of the device will void warranty.

By using this Honeywell literature, you agree that Honeywell will have no liability for any damages arising out of your use or modification to, the literature. You will defend and indemnify Honeywell, its affiliates and subsidiaries, from and against any liability, cost, or damages, including attorneys' fees, arising out of, or resulting from, any modification to the literature by you.

Automation and Control Solutions

Honeywell International Inc.
1985 Douglas Drive North
Golden Valley, MN 55422
customer.honeywell.com

Honeywell

© U.S. Registered Trademark
© 2011 Honeywell International Inc.
62-2019—05 M.S. Rev. 09-11
Printed in United States