

T775R Series 2000 Electronic Stand-Alone Controller

INSTALLATION INSTRUCTIONS

PRODUCT DESCRIPTION



The T775 electronic stand-alone controllers are the next generation of commercial and agricultural controls capable of remote sensing of temperature and providing switched and/or proportional outputs to various types of loads. A built-in time clock is standard.

A Reset function is available for all T775R models where the Sensor B temperature (e.g. outside temperature) is used to provide reset control for the Sensor A temperature (e.g. boiler). For example, as the outside temperature gets colder, the setpoint temperature automatically adjusts to save energy.

Three T775R models have analog (modulating) outputs for actuator and motor control.

IMPORTANT

The T775R is an operating control, not a limit or safety control. If used in applications requiring safety or limit controls, a separate safety or limit control device is required.

Table 1. T775R Controller Configurations.

Controller Model ^a	Description	Replaces	SPDT Relay Outputs	Analog (Mod) Outputs ^b	Floating Outputs ^c	Sensor Inputs	Nbr of Sensors Included	Enclosure
T775R2001	Reset Option	N/A	4	None	2	2	2	NEMA 1
T775R2019	Reset Option	N/A	4	2	None	2	2	NEMA 1
T775R2027	Reset Option	T775J1043 T775J1050 T775J1068	2	2	None	2	2	NEMA 1
T775R2035	Reset Option	T775J1001 T775J1076	2	None	1	2	2	NEMA 1
T775R2043	Reset Option	T775J1019 T775J1027 T775J1035	None	2	None	2 ^d	2	NEMA 1

^a All models include a digital input for use with the disable or setback option.

^b The modulating (analog) outputs are 4-20 mA, 0-10 Vdc, 2-10 Vdc, or Series 90 selectable.

^c Each floating output eliminates two SPDT relay outputs.

^d The T775R2043 can support a high/low modulating limit at Sensor B for temperature control at Sensor A.



Temperature Sensors^a

The controller accepts 1,097 Ohms PTC at 77° F (25° C):

- 50021579-001 – Standard sensor (2 standard sensors are included with each T775R model)
- T775-SENS-WR – Water resistant with 5 foot leads
- T775-SENS-WT – Watertight with 6 foot lead
- T775-SENS-OAT – Outdoor air temperature sensor
- C7031D2003 – 5 inch immersion sensor with wiring box (use immersion well; P/N 50001774-001)
- C7031J2009 – 12 foot duct averaging sensor with wiring box
- C7046D1008 – 8 inch duct probe with mounting flange
- C7100D1001 – 12 inch fast response, duct averaging sensor with flange
- C7130B1009 – Room mount sensor

^a Refer to form 62-0265 – *Temperature Sensors for the T775 Series 2000 Stand-alone Controller*

Accessories

- 107324A – Bulb Holder, duct insertion
- 107408 – Heat Conductive Compound, 4 ounce
- 50001774-001 – Immersion Well, stainless steel 304, 1/2 in. threading

Product Changes

Below are the changes to T775R models starting with Series 3 (March 2009). Series 3 can be identified by the sideways 3 after the part number on the device label.

1. For the T775R2043 model only, the modulating high and low limit now both function in either the heat or the cool mode.
2. MIN ON added.
3. SYNC added.
4. Differential and throttling range increased to 300°F.
5. Setpoint and Enable options added to the DI options.
6. HIDE option added to MOD1 and MOD2 (to hide them on the home screen).

Controller Dimensions

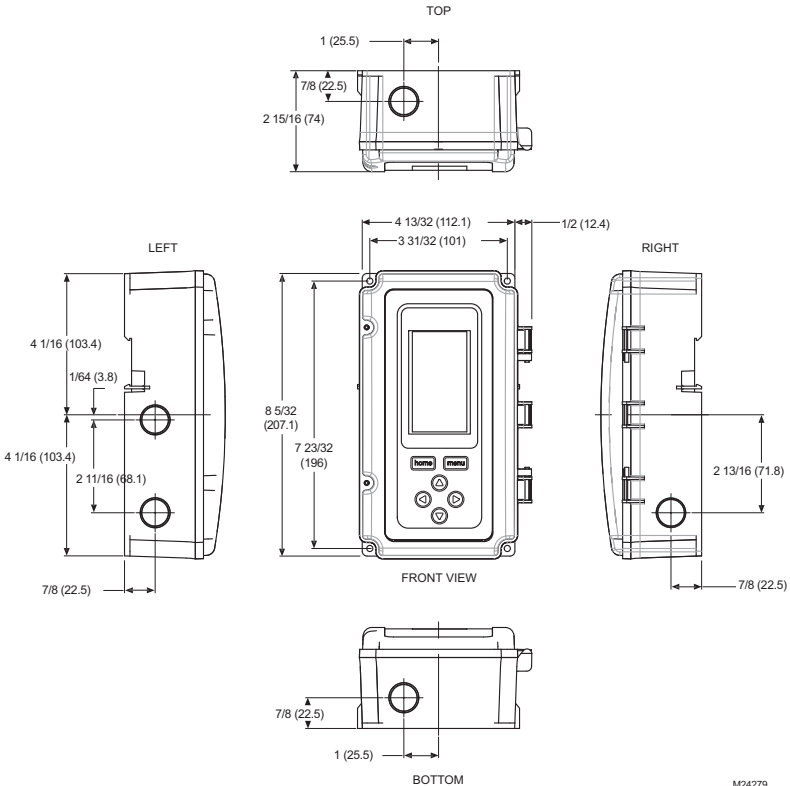

M24279

Fig. 1. T775R Dimensions in inches (mm).

BEFORE INSTALLATION

Review the “Specifications” on page 36 before installing the controller.

When Installing This Product

1. Read these instructions carefully. Failure to follow them could damage the product or cause a hazardous condition.
2. Check ratings given in instructions and on the product to ensure the product is suitable for your application.
3. Installer must be a trained, experienced service technician.
4. After installation is complete, check out product operation as provided in these instructions.

INSTALLATION AND SETUP

The following installation procedures are typically performed in the order listed:

1. Mounting — See below.
2. Wiring — See on this page.
3. Checkout — Refer to page 9.
4. Programming — Refer to page 11.
5. Scheduling (optional) — Refer to page 31.

Additional topics are:

- Temperature sensor calibration begins on page 9.
- Interface overview begins on page 10.
- Setup (for advanced options) begins on page 19.
- Summary menu begins on page 35.
- Troubleshooting begins on page 35.

MOUNTING

This section describes the mounting procedures for the controller and temperature sensor(s).

Controller Mounting

IMPORTANT

Avoid mounting in areas where acid fumes or other deteriorating vapors can attack the metal parts of the controller circuit board, or in areas where escaping gas or other explosive vapors are present.

IMPORTANT

The controller must be mounted in a position that allows clearance for wiring, servicing, and removal.

Use a screwdriver to pry out only the knockouts that you will use.

If mounting on DIN rail, be sure to remove the knockouts before mounting. Refer to “Controller Wiring” on page 5 and Fig. 7 on page 6 for recommended knockout usage and locations. If you do not use an opened knockout be sure to cover it.

Mount the controller on any convenient interior location using the four mounting holes provided on the back of the enclosure using #6 or #8 screws (screws are not provided and must be obtained separately). Use controller dimensions in Fig. 1 on page 2 as a guide.

The controller may be mounted in any orientation. However, mounting in the orientation shown in Fig. 1 on page 2 permits proper viewing of the LCD display and use of the keypad.

Temperature Sensor(s) Mounting and Location

Temperature sensors may be located up to 1,000 feet (304 m) from the T775R controller. Refer to “Temperature Sensor Calibration” on page 9 for calibration guidelines.

The sensors may be mounted on a wall or panel for sensing space temperature, strapped to a pipe or inserted in an immersion well (See Fig. 2) for hot or cold water sensing, or taped to a standard cap or bulb holder for duct air sensing. To prevent moisture or condensation entering the sensor through the lead wire holes, mount the sensor with the lead wires exiting the bottom of the sensor.

NOTES:

1. The included sensor is not designed for very wet applications. For immersion applications, an immersion well is used.
2. Heat conductive compound must be used in immersion wells.
3. Refer to “Temperature Sensors” on page 2 for this type of installation.

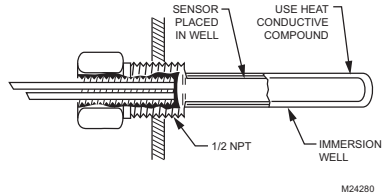

Fig. 2. Sensor Inserted in Immersion Well.

NOTE: Multiple sensors may be parallel-series wired to sense average temperatures in large spaces (Refer to Fig. 3 on page 4).

WIRING

All wiring must comply with applicable electrical codes and ordinances, or as specified on installation wiring diagrams. Controller wiring is terminated to the screw terminal blocks located inside the device.

The remainder of this section describes the temperature sensor wiring and the T775R controller wiring.

Wiring Connections Access

To access the wiring connections, remove the two screws on the left side of the enclosure and gently swing open the top. Be careful to not stress the ribbon cables that connect the keypad and LCD display to the controller circuit board.

Temperature Sensor Wiring

CAUTION

Electrical Shock Hazard.

Can short equipment circuitry.

Make sure that metal tube of sensor does not short against T terminals in wall-mounted case.

IMPORTANT

Poor wiring practices can cause erratic readings from the sensor. Avoid the following to ensure proper operation:

- Do not route the temperature sensor wiring with building power wiring.
- Do not locate the temperature sensor wiring next to control contactors.
- Do not locate the temperature sensor wiring near electrical motors.
- Do not locate the temperature sensor wiring near welding equipment.
- Make sure good mechanical connections are made to both the sensor and the controller.
- Do not mount the sensor with the lead wire end pointing up in an area where condensation can occur.

If any of the above conditions cannot be avoided, use shielded cable.

NOTE: Each T775 controller must be wired to its own sensor(s). However, a benefit of the T775 controller's accuracy is that there is no more than a 2° F (-17° C) differential between any two T775 controllers.

Reset Temperature Control

If you are implementing two-sensor reset control, Sensor A must always be the controlled temperature and Sensor B must always be the controlling temperature.

For example, in a reset control based on outside temperature, Sensor A must be the inside sensor and Sensor B must be the outside sensor.

Multiple Parallel Sensors

Multiple sensors can be parallel-series wired to sense average temperatures in large spaces. To maintain control accuracy, the number of sensors to be parallel-series wired must be of the n^2 power (for example, 4, 9, 16, etc.) (See Fig. 3).

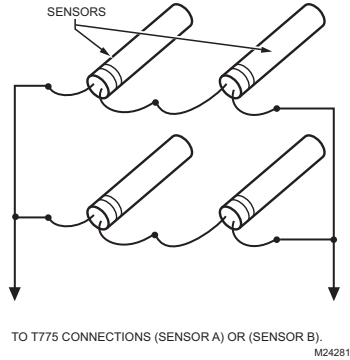

Fig. 3. Parallel-Series Wiring of Sensors.

Temperature Sensor Wire Type and Size

Temperature sensors use standard AWG 18/2 unshielded wire. For cable runs greater than 25 feet or where electrical interference may be a problem, shielded cable is recommended (See Fig. 4).

Refer to "Temperature Sensor Calibration" on page 9 for wire size selection where cable runs are longer than 25 feet.

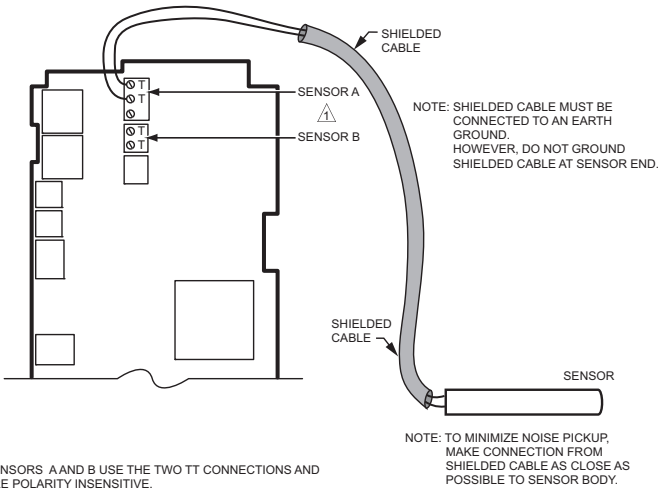

Fig. 4. Sensor Wiring — Showing Shielded Cable Connection to Sensor A.

Controller Wiring

! WARNING

Electrical Shock Hazard.
Can cause severe injury, death or property damage.

Disconnect power supply before beginning wiring, or making wiring connections, to prevent electrical shock or equipment damage.

! CAUTION

Do not use 24 Vac power to power any external loads if 120 Vac or 240 Vac is used to power the T775R.

! CAUTION

A separate earth ground is required. Equipment damage can result if the earth ground is not connected (See Fig. 5 and Refer to Table 2 on page 6).

! CAUTION

Equipment Damage Hazard. Electrostatic discharge can short equipment circuitry. Ensure that you are properly grounded before handling the unit.

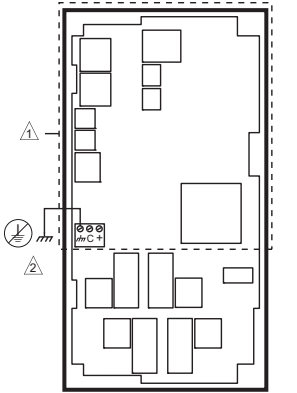

- !** NO HIGH VOLTAGE. CLASS 2 WIRING ONLY.
- !** EARTH GROUND TERMINAL MUST BE CONNECTED TO CONDUIT CLAMP LOCALLY.

M24296

Fig. 5. Earth Ground.

IMPORTANT

Poor wiring practices can cause erratic readings from the sensor. To ensure proper operation, ensure that good mechanical connections are made to both the sensor and the controller.

IMPORTANT

When wiring the input power, only one source of power can be applied to the T775R (24 Vac or 120 Vac or 240 Vac).

Refer to Fig. 7 on page 6 for locating the appropriate power input, remote sensors input, low voltage, contact closure, and load output terminals.

Access to the terminals can be gained through standard conduit knockouts (A through E in Fig. 7 on page 6) located around the perimeter of the enclosure:

- Knockouts A and B should be used only for sensor and low-voltage wiring.
- Knockouts C, D, and E can be used to gain access to the load relay output terminals and 120/240 Vac power wiring.

Controller Wiring Method

Wire the sensors and outputs, then wire the power connection.

Each terminal can accommodate the following gauges of wire:

- Single wire – from 14 AWG to 22 AWG solid or stranded
- Multiple wires – up to two 22 AWG stranded

For 24, 120, or 240 Vac power connections:

Single wire – from 14 to 18 AWG solid or stranded

Prepare wiring for the terminal blocks, as follows:

1. Strip 1/2 in. (13 mm) insulation from the conductor.
2. Cut a single wire to 3/16 in. (5 mm). Insert the wire in the required terminal location and tighten the screw.
3. If two or more wires are being inserted into one terminal location, twist the wires together a minimum of three turns before inserting them to ensure proper electrical contact.
4. Cut the twisted end of the wires to 3/16 in. (5 mm) before inserting them into the terminal and tightening the screw.
5. Pull on each wire in all terminals to check for good mechanical connection.

1. STRIP 1/2 IN. (13 MM) FROM WIRES TO BE ATTACHED AT ONE TERMINAL.

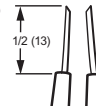

2. TWIST WIRES TOGETHER WITH PLIERS (A MINIMUM OF THREE TURNS).

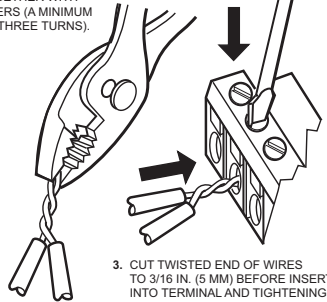

3. CUT TWISTED END OF WIRES TO 3/16 IN. (5 MM) BEFORE INSERTING INTO TERMINAL AND TIGHTENING SCREW. THEN PULL ON EACH WIRE IN ALL TERMINALS TO CHECK FOR GOOD MECHANICAL CONNECTION.

M24283

Fig. 6. Attaching two or more Wires at Terminal Blocks.

Controller Wiring Details

The wiring connection terminals are shown in Fig. 7 and are described in Table 2.

See Figures 8 through 18 for typical T775R wiring applications.

Table 2. Description of Wiring Terminal Connections. (Continued)

Connection	Terminal Label	Description
120 or 240 Vac Power		
120 Vac	120	120 Vac Power
Common	COM	Common
240 Vac	240	240 Vac Power

^a For Series 90 connections, you must insert a 340 Ohm resistor across terminals R and W (Refer to Fig. 17 on page 8). The resistor is included with the controller.

^b A separate earth ground is required for all installations regardless of the power source (24, 120, or 240 Vac).

WIRING APPLICATION EXAMPLES

Figures 8 through 18 illustrate typical controller wiring for various applications.

NOTE: For wiring examples of Series 90, M9184 or M9185 Modutrol Motors, refer to the *T775A/B/M Series 2000 Electronic Stand-alone Controllers Installation Instructions (form 62-0254)*.

NOTE: The Electronic Series 90 output provided with modulating T775 models cannot drive electromechanical slidewire devices like older Series 3 mod motors (prior to series 6), V9055s, and S984s.

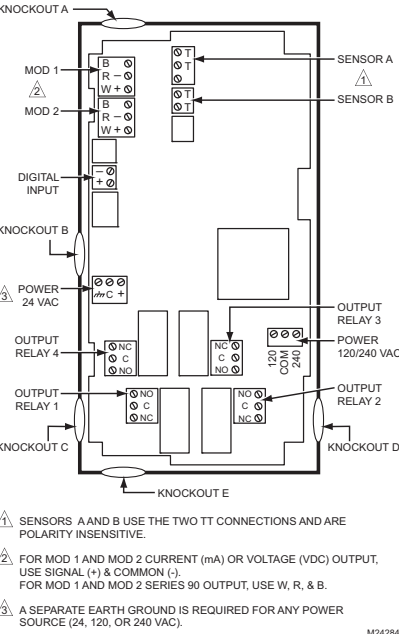

Fig. 7. T775R Terminal and Feature Locations.

NOTE: Refer to Table 1 on page 1 for the specific configuration of sensors and outputs supported by the model you are installing.

Table 2. Description of Wiring Terminal Connections.

Connection	Terminal Label	Description
Sensors		
Sensor A	T T	Temperature Sensor; polarity insensitive
Sensor B		
Outputs		
Relay 1		120-240 Vac Relay Output
Relay 2	NO	
Relay 3	COM	
Relay 4	NC	
Mod 1	+ - (Vdc or mA)	Modulating Output
Mod 2	W R B (Series 90) ^a	
Input		
DI	+ -	Digital Input (dry contact)
24 Vac Power		
24V +	+	24 Vac Hot
Common	C	24 Vac Common
Ground	/	Earth Ground ^b

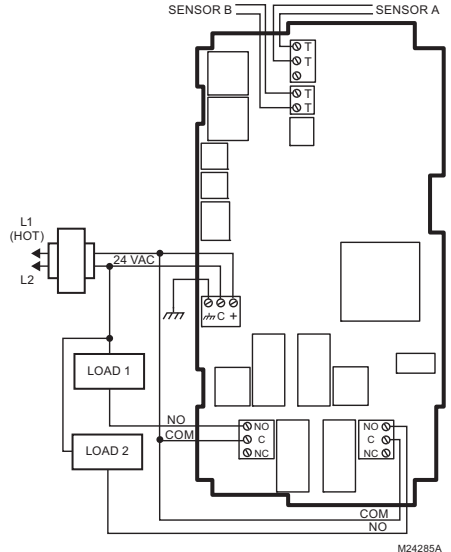

Fig. 8. Wiring for Two-Stage Control – 24 Vac Input and 24 Vac Load.

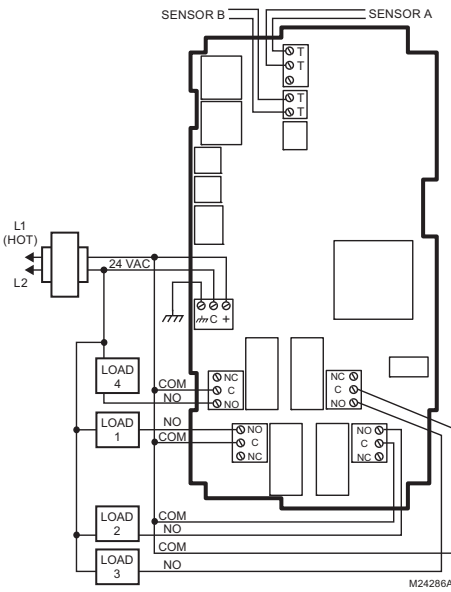

Fig. 9. Wiring for Four-Stage Control – 24 Vac Input and 24 Vac Load

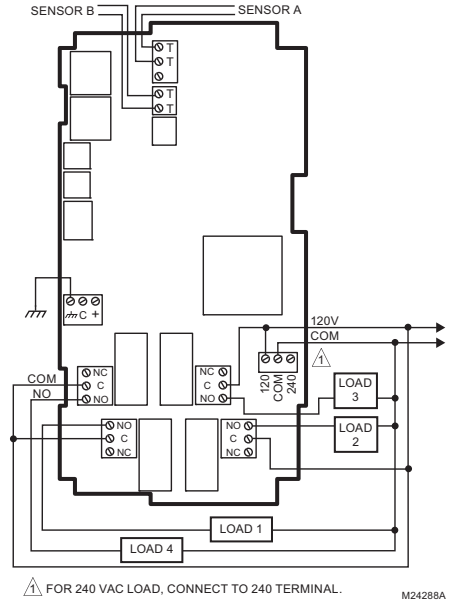

Fig. 11. Wiring for Four-Stage Control with 120 or 240 Vac (120 Vac Input and 120 Vac Load shown)

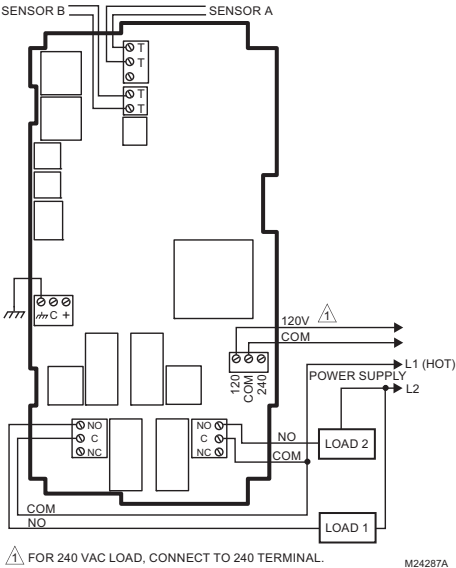

Fig. 10. Wiring for Two-Stage Control with 120 or 240 Vac (120 Vac Input and 120 Vac Load shown).

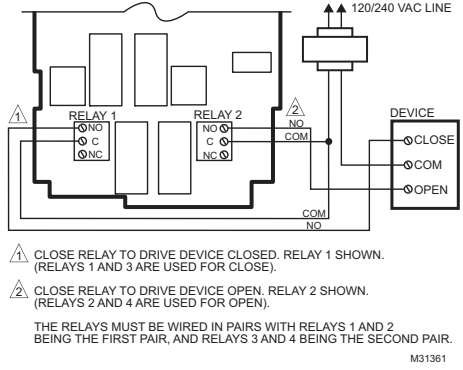

Fig. 12. Wiring for Floating Output (Relay 1 & Relay 2 pair shown)

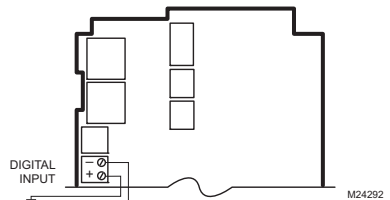

Fig. 13. Wiring for Digital Input (Dry Contact).

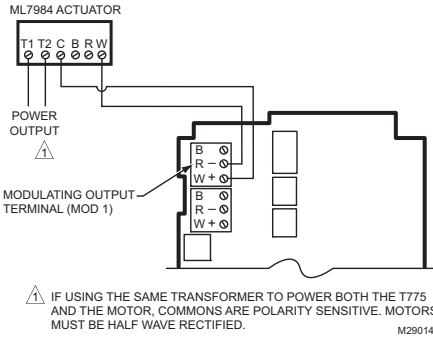

Fig. 14. Wiring for ML7984 Valve Actuator (Using 4-20 mA Signal).

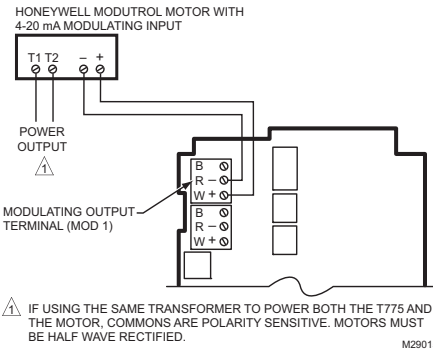

Fig. 15. Wiring for Mod Motor or Direct Coupled Actuator with 4 to 20 mA Control Input.

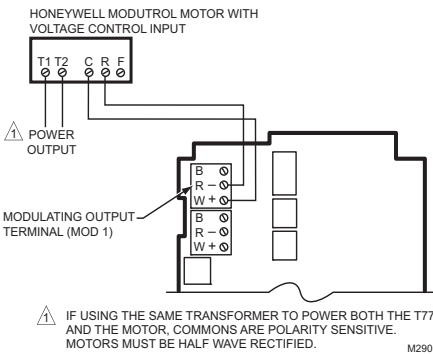

Fig. 16. Wiring for Mod Motor or Direct Coupled Actuator with 0-10 and 2-10 Vdc Control Input.

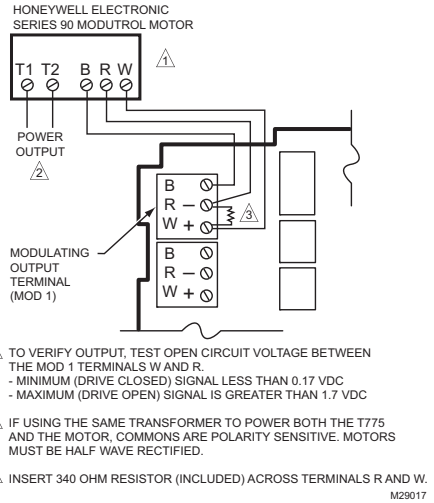

Fig. 17. Wiring for Series 90 Modutrol Motor Control

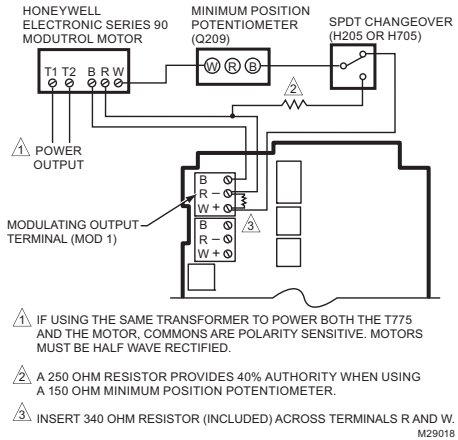

Fig. 18. Wiring for Changeover Relay and Minimum Position Potentiometer used with Series 90 Modutrol Motors.

CHECKOUT

Inspect all wiring connections at the controller terminals, and verify compliance with the installation wiring diagrams.

⚠ WARNING

Electrical Shock Hazard.
Can cause severe injury, death or property damage.

Disconnect power supply before beginning wiring or making wiring connections, to prevent electrical shock or equipment damage.

If any wiring changes are required, *first* be sure to remove power from the controller *before* starting work. Pay particular attention to verifying the power connection (24, 120, or 240 Vac).

After the controller is mounted and wired, apply power.

Power Loss

The date and time settings are retained for 24 hours after a power outage. After a power loss of more than 24 hours, the date and time settings may need to be reentered. All other settings are stored permanently.

Temperature Sensor Calibration

As wire length increases, resistance increases and thus the temperature reading increases. If necessary, calibrate the sensor input by reducing the value by the amount shown in the Tables 3 and 4. For example, a wire run with 18 gauge wire of 1,000 feet, requires a calibration offset of -6.0°F (-21° C).

IMPORTANT

If the calibration value in the table exceeds the controller's calibration limits of +/-10° F (+/-6° C), you must use a heavier gauge wire. For example, with a wire run of 1,000 feet you must use 20 AWG wire or heavier in order to calibrate for wire loss within the limits of the controller.

Refer to "3.2.2.2. CALIBRATE (the sensor)" on page 20 for the instructions to enter the calibration value.

Table 3. Temperature Sensor Calibration for Resistance Loss due to Wire Length (Feet).

AWG Rating	mΩ/ft	Temperature Offset in ° F (Foot) ^a		
		200 ft	500 ft	1,000 ft
14	2.5	0.46	1.14	2.28
16	4.0	0.72	1.82	3.64
18	6.4	1.16	2.90	5.82
20	10.2	1.86	4.64	9.28
22	16.1	2.92	7.32	14.64

^a This is the distance from the controller to the sensor (already accounts for round trip distance).

Table 4. Temperature Sensor Calibration for Resistance Loss due to Wire Length (Meters).

AWG Rating	mΩ/ft	Temperature Offset in ° C (Meter) ^a		
		100 m	200 m	300 m
14	8.3	0.44	0.86	1.30
16	13.2	0.68	1.38	2.06
18	21.0	1.10	2.18	3.28
20	33.5	1.74	3.48	5.22
22	52.8	2.74	5.48	8.22

Fig. 19 shows how sensor resistance varies with temperature for a sensor having a positive temperature coefficient (PTC) of 2.1 Ohms per degree F (3.85 Ohms per degree C).

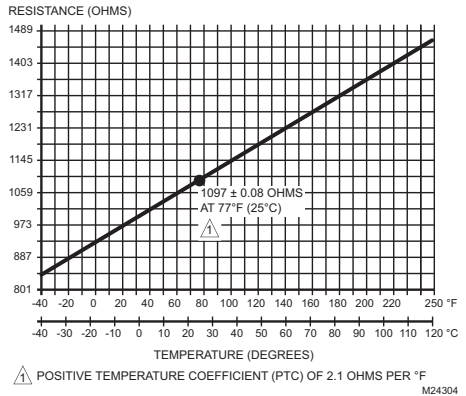

Fig. 19. Sensor Resistance vs. Temperature.

INTERFACE OVERVIEW

The T775R controller uses an LCD panel and 6-button keypad to provide status information and permit user input of the programming, setup, and scheduling parameters.

The following figure describes the display areas of the LCD and the keypad.

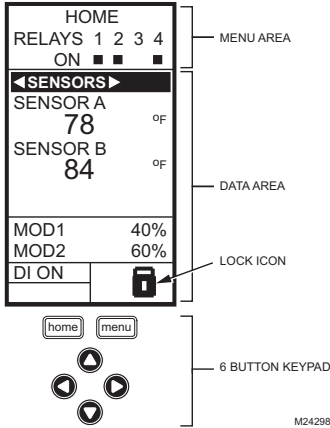

Fig. 20. LCD Display - Home Screen And Keypad.

Menu Area – On the home screen, the LCD displays the configured relays and whether they are active. In Program, Setup or Schedule mode, the LCD displays the current menu selection within the menu hierarchy.

Data Area – On the home screen, the LCD displays the sensors and outputs status. In Setup or Program mode, the LCD displays menu choices, parameter selections, and data values.

Lock Icon – The icon indicates the **MENU** button is locked and prevents access to the Setup and Program menus.

NOTE: Pressing and holding the **HOME** and **MENU** buttons simultaneously for five seconds locks/unlocks the **MENU** button.

6-Button Keypad – The keypad is used to access the menus and enter values (See “Using the LCD Panel Interface”).

Using the LCD Panel Interface

The 6-button keypad is used to move through the menus and enter or change parameter values.

Home Button

Pressing the **HOME** button at any time exits the current Programming or Setup display screen and returns to the home screen as shown in Fig. 20 and Fig. 21.

Menu Button

- Pressing the **MENU** button always displays the Program menu. If you are in Setup mode, you exit setup and return to the Program menu.
- Pressing and holding the **MENU** button for five seconds leaves the current screen and displays the Setup menu.

Left and Right Arrow Buttons (◀ and ▶)

Use these buttons to move backward (◀) and forward (▶) through the Program and Setup menus.

Up and Down Arrow Buttons (▲ and ▼)

Use these buttons to move your selection up and down through a menu or list.

- When the desired item is highlighted, you press the ▶ arrow button to display that item’s content.
- When a value is displayed (e.g. 70°F (82° C)), the up and down arrows increase and decrease the value.

NOTE: Once you select an item from a list or enter a value, pressing the ◀ or ▶ or HOME button accepts your selection or value and stores it in the controller’s memory.

Home Screen

In the normal run state, the LCD home screen displays the current sensed temperatures, the modulating outputs status, the active status of the output relays, and error and status codes.

When using Reset, the Heat/Cool setpoint(s) display on the home screen for the Mod and Relay outputs; (See Fig. 21).

Active relays are indicated by the small black square (■) just below the relay number. Fig. 21 shows the home screen with relays 1, 2, and 4 energized.

Pressing the ◀ and ▶ buttons from the home screen cycles through each modulating output that is paired with the sensor it controls and the active output relays.

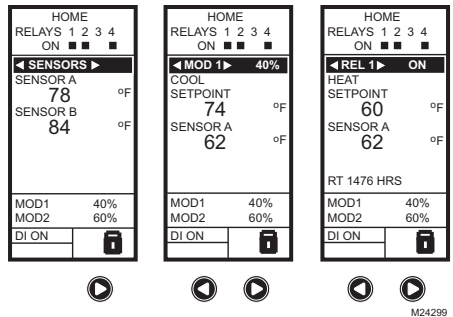

Fig. 21. LCD Display - Home Screen Displaying Sensors, Mod Outputs, and Active Relays.

NOTES:

- The modulating output home screen and the relay home screen do not dynamically update the active relay status, sensor values, and modulating output percentages. The information is a snapshot taken when you press the ◀ or ▶ button to display the screen.
- In Reset mode, the home screen displays the effective setpoint.

IMPORTANT

After four minutes of inactivity (no buttons pressed), the LCD display reverts to the home screen display.

Accessing the Menus

Menus are used for programming, scheduling, viewing the summary settings, and setup of advanced options.

Program, Schedule, and Summary Menus

To access these menus from the home screen, press the **MENU** button (See Fig. 22).

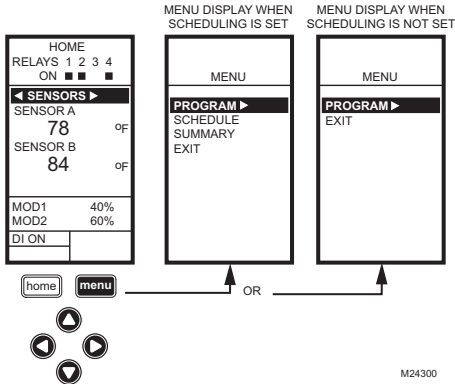

Fig. 22. Menus.

Depending on whether scheduling is enabled or not, the LCD displays one of two menus as shown in Fig. 22. Scheduling is enabled from the Setup menu's Output settings (Refer to "3.3.5.1. USE SCHED" on page 26).

Setup Menu

To access the Setup menu for advanced options, press and hold the **MENU** button for five seconds (See Fig. 23).

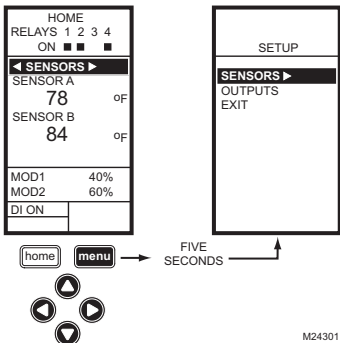

Fig. 23. Setup Menu.

Using the Menus

When you are working with the menus, use the:

- **Left arrow button** (◀) to scroll backward through the menus
- **Right arrow button** (▶) to select the highlighted menu item and display its content
- **Up and Down arrow buttons** (▲ and ▼) to scroll up and down through a list of items or to increase or decrease the value of a displayed parameter

NOTES:

1. If you press the **HOME** button or there is no keypad activity for four minutes, you exit Program mode and return to the home screen.
2. If you press the **MENU** button, you exit and return to the menu.

PROGRAMMING

The controller must be programmed before being placed into service.

IMPORTANT

During programming, the controller is live at all times. For example, the contacts may open and close when adjusting the setpoint.

The programming process uses a hierarchical menu structure that is easy to use. You press the ◀ and ▶ arrow buttons to move forward and backward through the menus.

NOTES:

1. The T775P controller interface is intuitive. You may want to use these procedures simply as a reference to locate the particular option or parameter of interest.
2. The menus can display only those relays that are defined in Setup (Refer to "3.3.4. NBR OF RELAYS" on page 25). For example, if you configure only two relays, then only two relays display on the appropriate menus.
3. If you press the **HOME** button or there is no keypad activity for four minutes, you exit Program mode and return to the home screen.
4. If you press the **MENU** button, you exit Program mode and return to the menu.

Setpoint and Differential

The following describes the relationship between setpoint and differential for heating and cooling. These settings are programmed for each output relay.

Heating Mode Setpoint and Differential

In heating mode, the differential is below the setpoint. The relay de-energizes when the temperature rises to the setpoint. As the temperature drops to the setpoint minus the differential, the relay energizes.

Cooling Mode Setpoint and Differential

In cooling mode, the differential is above the setpoint. The relay de-energizes when the temperature falls to the setpoint. As the temperature rises to the setpoint plus the differential, the relay energizes.

Setpoint High Limit

You can set an irreversible setpoint high limit maximum value for any single displayed setpoint value.

Adjust the setpoint (at any output) to the desired maximum setpoint. Then, simultaneously press the **HOME**, ◀, and ▶ buttons and continue to press all three buttons for five seconds to set the setpoint high limit maximum to this value.

NOTE: You must press all three buttons at exactly the same time for this action to occur.

IMPORTANT

1. This action sets the maximum setpoint value of all outputs to the setpoint high limit maximum.
2. Setting the high limit setpoint maximum is irreversible. If you perform the action inadvertently and this setpoint adversely affects the control of your system, you must replace the controller.

Programming the T775R Controller

To program the controller, select one of the following procedures depending on whether the Reset function is to be used:

- Program Outputs for Reset — See “1. Programming Outputs (Relay and Mod) with Reset” on page 12
- Program Outputs for No Reset — Refer to “2. Programming Outputs (Relay and Mod) with No Reset” on page 16

When programming is complete, you may continue with “4. Scheduling” on page 31 or, for advanced options, continue with “3. Setup (Advanced Options)” on page 19.

1. PROGRAMMING OUTPUTS (RELAY AND MOD) WITH RESET

The T775R can be programmed for Reset or No Reset for each output. From the factory, the T775R is programmed for No Reset. This section describes the steps necessary to program the controller for Reset.

To use the Reset feature, the first output (MOD 1 or Relay 1 depending on the model) must be set to Reset=YES in Setup mode (See “1.1. Setting Up the Controller for Reset”).

The reset curve established when programming the first output (MOD 1) is then used for all subsequent outputs that are configured for Reset, and each of those outputs will be offset from this curve.

For all outputs that will follow a reset curve, be sure to configure for Reset=YES in the setup mode. Choose Reset YES or NO for all other outputs you wish to reset, then press the HOME button to record your selection.

CAUTION
 If using the time clock or DI to go to setback, the T775R will shift the reset curve up or down and cause the controlled setpoint to exceed either the entered reset max. temp or min. temp (dropping below reset minimum is most common, since setback is normally below setpoint). If this is not desired, either do not use setback, or adjust the min. and max. values entered so that critical setpoints are not exceeded in the setback mode.

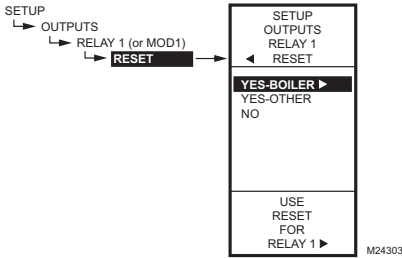

Fig. 24. Reset Setup.

1.1. Setting Up the Controller for Reset

1. Press and hold the MENU button for five seconds to enter Setup mode.
2. Then choose:
 OUTPUTS ▶
 RELAY 1 (or MOD1 if Mod outputs present) ▶
 RESET ▶
 then select YES -BOILER or YES-OTHER.

You can now press the HOME button to exit Setup mode and continue with “Determining and Setting the Reset Values”.

Determining and Setting the Reset Values

NOTE: When using the Reset feature, Sensor A must be sensing the controlled temperature (e.g. Boiler), Sensor B must be sensing the resetting temperature (e.g. outdoor temp).

To program an output for Reset, refer to the values as shown in the examples below and in Fig. 25 on page 13. Choose your own appropriate values for Sensor A maximum and minimum and Sensor B maximum and minimum.

Reset Example: (Refer to Fig. 25 on page 13)

- Sensor A is the boiler sensor and Sensor B is the outdoor sensor.

- Maximum boiler temperature desired is 210°F (99°C) when the outdoor temperature is 20°F (-7°C).
- Minimum boiler temperature desired is 160°F (71°C) when the outdoor temperature is 70°F (21°C).
- With the above settings example, when the outdoor temperature is 50°F (10°C), the effective setpoint is 180°F (82°C).

Setback (optional) Example: (Refer to Fig. 25 on page 13)

- Setback of -10°F (-12°C) is used to drop the temperature at night by 10°F (-12°C).
- With the above settings example, when the outdoor temperature is 50°F (10°C), the effective setback setpoint is 170°F (77°C) (180°F (82°C) setpoint minus the 10°F (-12°C) setback).

NOTES:

1. A single reset curve is programmed for the first output and is used by all outputs setup with RESET=YES.
2. For subsequent outputs (MOD and Relay), a setpoint *offset* is used if that output is also being Reset. Refer to "1.2.9.1 SETPOINT OFFSET (subsequent outputs only)" on page 16.
3. When setback is used, the minimum and maximum boiler temperature setpoints that were entered will also be offset by the setback offset. This may not be desired if it is necessary to maintain the minimum temperature (to avoid condensing) or maximum temperature entered in the reset schedule. In this case, we recommend adjusting the minimum and/or maximum temperature by the offset so that during setback the desired limits are maintained.

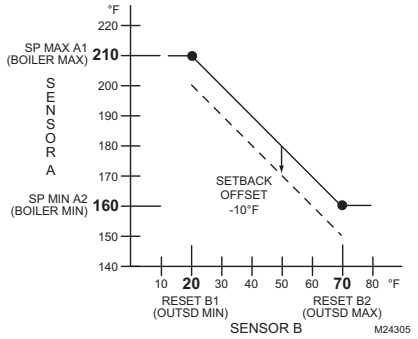

Fig. 25. Reset Curve for First Output with Setback Offset.

When Reset is programmed, the home screen conveniently displays the calculated Heat/Cool setpoint(s) for the Mod and Relay outputs based on the reset curve (Refer to Fig. 21 on page 10).

The remainder of this section, beginning with "1.2. Entering Program Mode", describes the individual parameters for configuring outputs with Reset. For your reference, the following Reset programming procedure uses the values in Fig. 25.

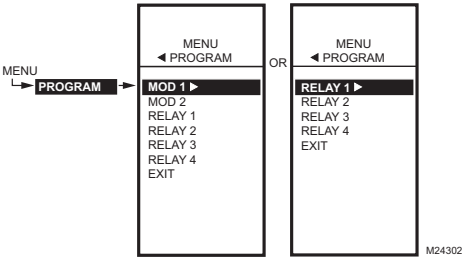

Fig. 26. Program Menu.

1.2. Entering Program Mode

Press the **MENU** button, then select **PROGRAM** and press the **▶** button to view the Program menu.

NOTE: Modulating outputs are not available on controller models T775R2001 and T775R2035.

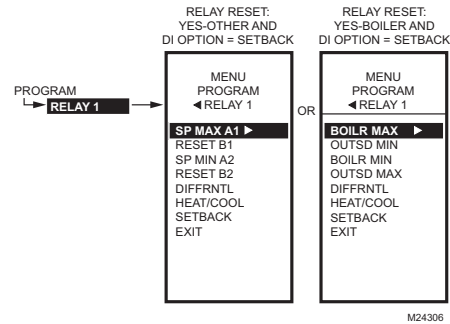

Fig. 27. Setpoint Values for Reset and Setback.

1.2.1. Program Menus for Outputs with Reset

Press the **MENU** button, select **PROGRAM**, then select **RELAY 1** (or **MOD 1**) to view the parameters.

The Reset settings (Figures 28 through 31 on page 14) are programmed for the first output and these settings apply to all outputs that are configured for Reset. See Fig. 25 on page 13 for the reset curve values used in the following section.

NOTE: The Setback parameter displays only if scheduling is enabled (refer to Fig. 65 on page 26) or the DI Option is set to Setback (refer to Fig. 67 on page 27).

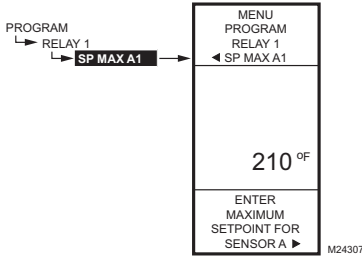

Fig. 28. Program - Sensor A Max. Setpoint.

1.2.2. SP MAX A1 or BOILER MAX

Setpoint maximum for Sensor A.

1. From the menu, use the ▲ and ▼ buttons to highlight BOILER MAX or SP MAX A1.
2. Press the ► button to display the maximum setpoint value.
3. Use the ▲ and ▼ buttons to increase/decrease the desired maximum setpoint temperature.
Default: 180° F (82° C)
Range: -40° to 248° F (-40° to 120° C)
4. Press the ► button to accept the setpoint temperature and display the next option.

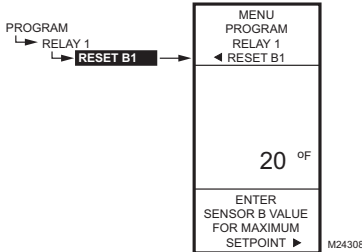

Fig. 29. Program -Sensor B Max. Setpoint.

1.2.3. RESET B1 or OUTSD MIN

Sensor B value when at SP MAX A1 Setpoint.

1. From the menu, use the ▲ and ▼ buttons to highlight RESET B1 or OUTSD MIN.
2. Press the ► button to display the setpoint value.
3. Use the ▲ and ▼ buttons to increase/decrease the desired setpoint temperature.
Default: 10° F (-12° C)
Range: -40° to 248° F (-40° to 120° C)
4. Press the ► button to accept the value and display the next option.

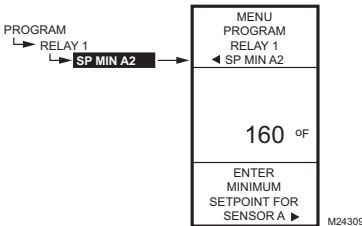

Fig. 30. Program - Sensor A Min. Setpoint.

1.2.4. SP MIN A2 or BOILER MIN

Setpoint minimum for Sensor A B value when at SP MAX A1 Setpoint.

1. From the menu, use the ▲ and ▼ buttons to highlight BOILER MIN or SP MIN A2.
2. Press the ► button to display the setpoint value.
3. Use the ▲ and ▼ buttons to increase/decrease the desired minimum setpoint temperature.
Default: 140° F (60° C)
Range: -40° to 248° F (-40° to 120° C)
4. Press the ► button to accept the setpoint temperature and display the next option.

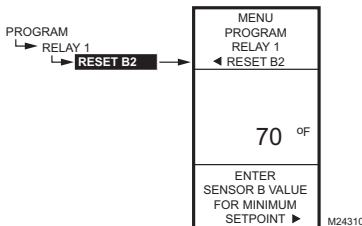

Fig. 31. Program - Sensor B Min. Setpoint.

1.2.5. RESET B2 or OUTSD MAX

Sensor B value when at MIN A2 Setpoint.

1. From the menu, use the ▲ and ▼ buttons to highlight RESET B2.
2. Press the ► button to display the setpoint value.
3. Use the ▲ and ▼ buttons to increase/decrease the desired setpoint temperature.
Default: 60° F (16° C)
Range: -40° to 248° F (-40° to 120° C)
4. Press the ► button to accept the value and display the next option.

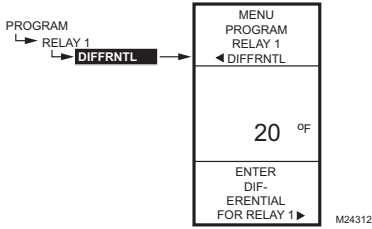

Fig. 32. Program - Differential or Throttling Range.

1.2.6. DIFFERENTIAL or THROTTLING RANGE

Differential displays for Relay outputs and Throttling Range is used for Modulating outputs.

1. From the menu, use the ▲ and ▼ buttons to highlight DIFFERNTL or THROT RNG.
 2. Press the ► button to display the throttling range value.
 3. Use the ▲ and ▼ buttons to increase/decrease the desired value.
 Default: 20° F (-07° C)
 Range: 1° to 300° F (1° to 149° C)
 4. Press the ► button to accept the value and display the next option.
- c. The Throttling Range brackets the setpoint setting, e.g., if the setpoint is 72° F (22° C) and the throttling range is 10° F (-12° C), then the effective throttling temperature range is 67° to 77° F (17° to 25° C). This applies to both modulating outputs and floating outputs.

NOTES:

- a. In heating mode, the Differential is below the setpoint. The relay de-energizes when the temperature rises to the setpoint. As the temperature drops to the setpoint minus the Differential, the relay energizes.
- b. In cooling mode, the Differential is above the setpoint. The relay de-energizes when the temperature falls to the setpoint. As the temperature rises to the setpoint plus the Differential, the relay energizes.

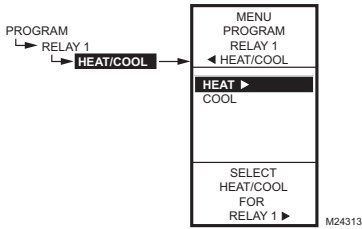

Fig. 33. Program - Heat/Cool Selection.

1.2.7. HEAT/COOL

1. From the menu, use the ▲ and ▼ buttons to highlight HEAT/COOL.
 Default: HEAT
2. Press the ► button to display the heat and cool selections.
3. Use the ▲ and ▼ buttons to select Heat or Cool.
4. Press the ► button to accept the highlighted selection and display the Mod 1 menu.
5. Use the ▲ and ▼ buttons to highlight EXIT.
6. Press the ► button to accept the value and display the next option.

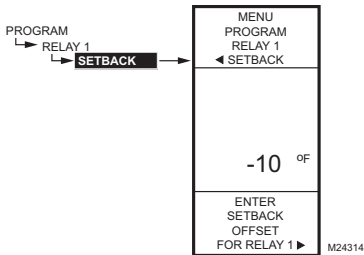

Fig. 34. Program - Setback.

1.2.8. SETBACK OFFSET (if configured)

The Setback temperature option displays only if scheduling is enabled (refer to Fig. 65 on page 26) or the DI Option is set to Setback (refer to Fig. 67 on page 27).

This value is the number of degrees plus (+) or minus (-) that you want the temperature to be offset from the setpoint.

For example, If you want the temperature to be 10° F (-12° C) less than the setpoint during setback mode, enter -10° F (-12° C). In normal operations for heating, the offset will be negative. For cooling, the offset will be a positive value.

1. From the menu, use the ▲ and ▼ buttons to highlight SETBACK.
2. Use the ▲ and ▼ buttons to increase/decrease the desired setpoint temperature.
 Default: 0° F (-18° C)
 Range: -150° to 150° F (-101° to 66° C)
3. Press the ► button to accept the value and display the menu.

This completes the programming of the first Reset output.

To program the subsequent outputs (e.g. MOD 2, Relay 2, Relay 3, etc.), continue with "1.2.9. Subsequent Outputs" on page 16.

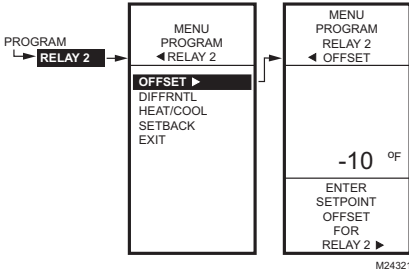

Fig. 35. Program - Setpoint Offset (Subsequent Outputs only).

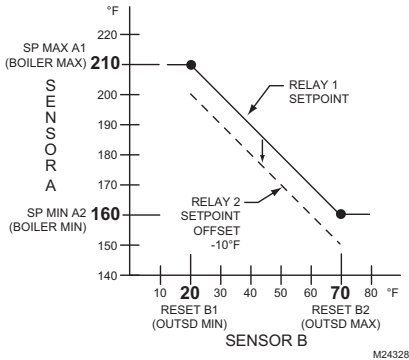

Fig. 36. Reset Curve with Offset for Subsequent Outputs.

1.2.9. Subsequent Outputs

For the subsequent outputs (MOD 2, Relay 2, Relay 3, etc. (if they are configured for Reset), the Offset parameter displays on the Program menu as shown in Fig. 35.

1.2.9.1 SETPOINT OFFSET (subsequent outputs only)

This value is the number of degrees plus (+) or minus (-) that you want the temperature to be offset from the first output's setpoint. For example (as shown in Fig. 36), If you want the MOD 2 setpoint to be 10° F (-12° C) less than the MOD 1 setpoint, enter -10° F (-12° C).

1. From the menu, use the ▲ and ▼ buttons to highlight OFFSET.
2. Press the ► button to display the value.
3. Use the ▲ and ▼ buttons to increase/decrease the desired temperature.
 OFFSET Default: 0°F (-18° C)
 OFFSET Range: -150° to 150° F (-101° to 66° C)
4. Press the ► button to accept the value and display the next option.

1.2.9.2 Subsequent Outputs Programming

To complete the programming an output, perform the procedures in "1.2.6. DIFFERENTIAL or THROTTLING RANGE" through "1.2.8. SETBACK OFFSET (if configured)" beginning on page 15.

1.3. Exit Programming with Reset

When you finish programming all the outputs, press the HOME button to leave programming mode and return to the home screen.

This completes the programming procedure for controllers that use Reset.

2. PROGRAMMING OUTPUTS (RELAY AND MOD) WITH NO RESET

The T775R can be programmed for Reset or No Reset. From the factory, the T775R is programmed for No Reset. This section describes the steps necessary to program the controller for No Reset.

2.1. Entering Program Mode

Press the MENU button, then select PROGRAM and press the ► button to view the Program menu.

NOTE: Modulating outputs are not available on controller models T775R2001 and T775R2035.

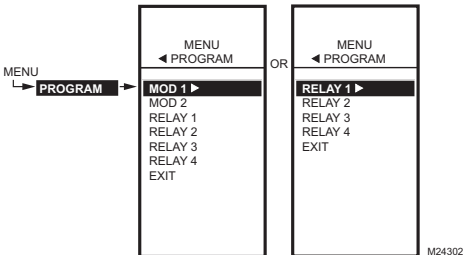

Fig. 37. Program Menu.

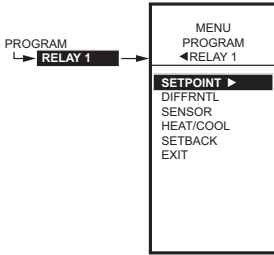

Fig. 38. Program Menu - No Reset.

2.1.1. Program Menu for Outputs with No Reset

Press the **MENU** button, select **PROGRAM**, then highlight the **MOD** or **Relay** desired and press the **▶** button to view the parameters. Fig. 38 shows **RELAY 1**.

NOTE: For **MOD 1** and **2**, **THROT RNG** replaces **DIFFRNTL**.

NOTE: The **Setback** parameter displays only if **scheduling is enabled** (refer to Fig. 65 on page 26) or the **DI Option** is set to **Setback** (refer to Fig. 67 on page 27).

Continue with “2.1.2. SETPOINT”.

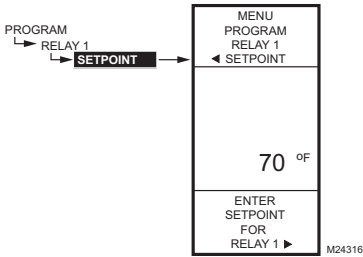

Fig. 39. Program - Setpoint.

2.1.2. SETPOINT

1. From the menu, use the **▲** and **▼** buttons to highlight **SETPOINT**.
2. Press the **▶** button to display the setpoint value.
3. Use the **▲** and **▼** buttons to increase/decrease the desired setpoint temperature.
Default: 70° F (21° C)
Range: -40° to 248° F (-40° to 120° C)
4. Press the **▶** button to accept the setpoint temperature and display the next option.

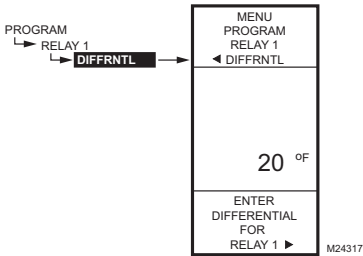

Fig. 40. Program - Differential or Throttling Range.

2.1.3. DIFFERENTIAL or THROTTLING RANGE

Differential displays for the Relay outputs and Throttling Range is used for Modulating outputs.

1. From the menu, use the **▲** and **▼** buttons to highlight **DIFFRNTL** or **THROT RNG**.
 2. Press the **▶** button to display the throttling range value.
 3. Use the **▲** and **▼** buttons to increase/decrease the desired value.
Default: 20° F (-6.6° C)
Range: 1° to 300° F (1° to 149° C)
 4. Press the **▶** button to accept the value and display the next option.
- c. The Throttling Range brackets the setpoint setting, e.g., if the setpoint is 72° F (22° C) and the throttling range is 10° F (-12° C), then the effective throttling temperature range is 67° to 77° F (19° to 25° C). This applies to both modulating outputs and floating outputs.

NOTES:

- a. In heating mode, the Differential is below the setpoint. The relay de-energizes when the temperature rises to the setpoint. As the temperature drops to the setpoint minus the Differential, the relay energizes.
- b. In cooling mode, the Differential is above the setpoint. The relay de-energizes when the temperature falls to the setpoint. As the temperature rises to the setpoint plus the Differential, the relay energizes.

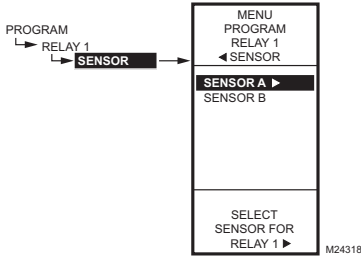

Fig. 41. Program - Sensor.

2.1.4. SENSOR

1. From the menu, use the ▲ and ▼ buttons to highlight SENSOR.
2. Press the ► button to display the sensor selections.
3. Use the ▲ and ▼ buttons to select Sensor A or B.
4. Press the ► button to accept the highlighted sensor and display the next option.

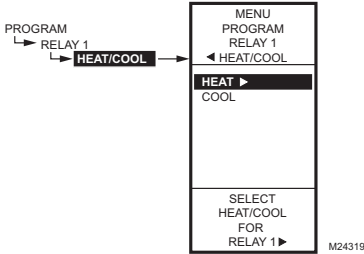

Fig. 42. Program - Heat/Cool.

2.1.5. HEAT/COOL

1. From the menu, use the ▲ and ▼ buttons to highlight HEAT/COOL.
Default: HEAT
2. Press the ► button to display the heat and cool selections.
3. Use the ▲ and ▼ buttons to select Heat or Cool.
4. Press the ► button to accept the highlighted selection and display the next option.

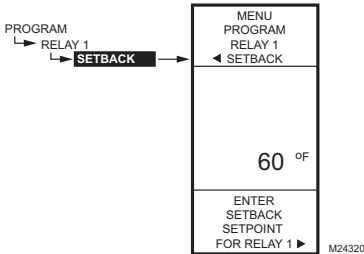

Fig. 43. Program - Setback.

2.1.6. SETBACK

The Setback temperature option displays only if scheduling is enabled (see Fig. 65 on page 26) or the DI Option is set to Setback (see Fig. 67 on page 27).

This is the desired setpoint temperature that you want to use during setback mode for this output. For example, if your setpoint is 70° F (21° C) and you want the temperature to drop 10° F (-12° C) during setback mode, enter 60° F (16° C) as the setpoint for this output.

1. From the menu, use the ▲ and ▼ buttons to highlight SETBACK.
2. Use the ▲ and ▼ buttons to increase/decrease the desired setpoint temperature.
Default: 60° F (16° C)
Range: -40° to 248° F (-40° to 120° C)
3. Press the ► button to accept the value and display the menu.

2.2. Program Next Output

Refer to Fig. 38 on page 17 to program the next output. When you finish the outputs, continue with "2.3. Exit Programming without Reset".

2.3. Exit Programming without Reset

Press the HOME button to leave programming mode and return to the home screen.

This completes the programming procedure for controllers that do not use Reset.

3. SETUP (ADVANCED OPTIONS)

Setup provides the ability to change the factory default settings for the temperature sensors and outputs, to enable/disable reset control, and to enable/disable scheduling.

NOTE: The T775R controller interface is intuitive. You may find that you do not need the following setup instructions for the sensors and outputs. You may want to use this procedure simply as a reference to locate the particular option or parameter of interest.

- NOTES:
1. If you press the **HOME** button or there is no keypad activity for four minutes, you exit Setup mode and return to the home screen.
 2. If you press the **MENU** button, you exit Setup mode and return to the menu.

Once in Setup mode, you use the —

- **Left arrow button (◀)** to scroll backward through the Setup menus
- **Right arrow button (▶)** to select the highlighted menu item and display its content
- **Up and Down arrow buttons (▲ and ▼)** to scroll up and down through a list of items or to increase or decrease the value of a displayed setup parameter

Setup Procedure

The Setup process uses a hierarchical menu structure that is easy to use. You press the ◀ and ▶ arrow buttons to move forward and backward through the menus.

NOTE: The menus can display only those relays that are defined in Setup (refer to “3.3.4. NBR OF RELAYS” on page 25). For example, if you configure only two relays, then only two relays display on the appropriate menus.

To change the controller’s sensors and output setup parameters, perform the following procedures in the order listed:

1. Enter Setup mode — See “3.1. Entering Setup Mode”
2. Setup Sensors — See “3.2. Setting up the Sensors”
3. Setup Outputs — Refer to “3.3.3. Setting up the Outputs” on page 22

3.1. Entering Setup Mode

To enter Setup mode, press and hold the **MENU** button for five seconds to display the Setup menu. Refer to Fig. 23 on page 11.

3.2. Setting up the Sensors

1. From the Setup menu, use the ▲ and ▼ buttons to highlight **SENSORS**.
2. Press the ▶ button to display the Sensors menu.

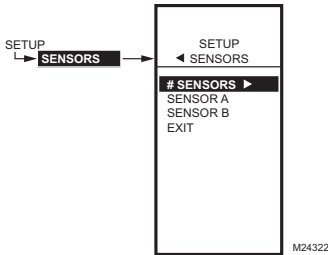

Fig. 44. Setup - Sensors Menu.

3.2.1. Number of SENSORS

The value entered here determines the number of sensors displayed on the home screen.

1. From the Sensors menu, highlight **# SENSORS** then press the ▶ button to display the number of sensors.
2. Use the ▲ and ▼ buttons to enter the number of sensors (1 or 2).
Default: 2
3. Press the ▶ button to accept the value and display the **SENSOR A** selection.

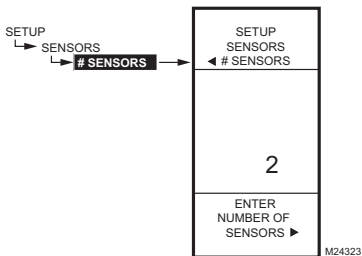

Fig. 45. Setup - Sensors - Number of Sensors.

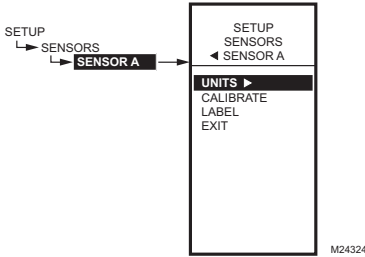

Fig. 46. Setup - Sensors - Sensor A Menu.

3.2.2. SENSOR A

If you are implementing two-sensor reset control, Sensor A must always be the controlled temperature and Sensor B must always be the controlling temperature. For example, in a reset control based on outside temperature, Sensor A must be the inside sensor and Sensor B must be the outside sensor.

1. From the Sensors menu, highlight SENSOR A.
2. Press the ► button to display the Sensor A selections.

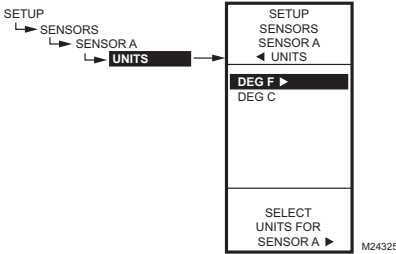

Fig. 47. Setup - Sensors - Sensor A - Units.

3.2.2.1. UNITS (° F or ° C)

IMPORTANT

This is a global change and affects the unit values for all temperature parameters on all displays.

This UNITS screen displays only for Sensor A.

1. From the Sensor A selections, use the ▲ and ▼ buttons to highlight UNITS.
2. Press the ► button to display the temperature units.
3. Use the ▲ and ▼ buttons to highlight F or C.
Default: F (Fahrenheit)
4. Press the ► button to accept the units and return to the Sensor A selections.

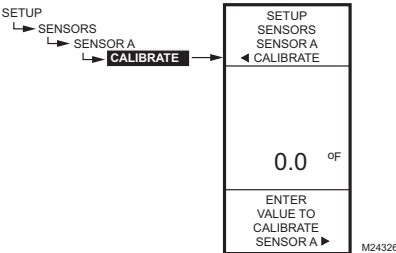

Fig. 48. Setup - Sensors - Sensor A - Calibrate.

3.2.2.2. CALIBRATE (the sensor)

Ensure that the wire size calibration value is within the limits. Refer to “Temperature Sensor Calibration” on page 9.

1. From the Sensor A selections, use the ▲ and ▼ buttons to highlight CALIBRATE.
2. Press the ► button to display the calibration degree value.
3. Use the ▲ and ▼ buttons to increase/decrease the desired calibration degrees.
Default: 0.0
Range: +/-10° F (+/-6° C)
4. Press the ► button to accept the value and return to the Sensor A selections.

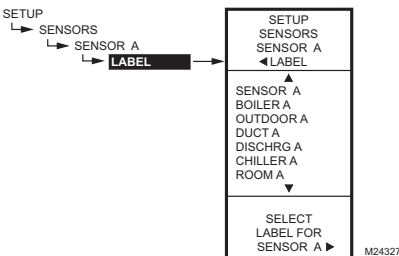

Fig. 49. Setup - Sensors - Sensor A - Label.

3.2.2.3. LABEL (the sensor input)

For a sensor already labeled, the display positions to and highlights that label.

1. From the Sensor A selections, use the ▲ and ▼ buttons to highlight LABEL.
2. Press the ► button to display the label list.
3. Use the ▲ and ▼ buttons to scroll through list and highlight the desired label. You may need to scroll up or down to view all possible labels.
4. Use the ► button to accept the highlighted label and exit the list.

NOTE: The label names in list order are: Sensor, Boiler, Outdoor, Duct, Dischrg, Chiller, Room, Supply, Return, and Animals.

3.2.2.4. Exit Sensor A Setup

Press the ◀ button to exit Sensor A selections and return to the Sensors menu.

or
Use the ▲ and ▼ buttons to highlight EXIT and press the ▶ button.

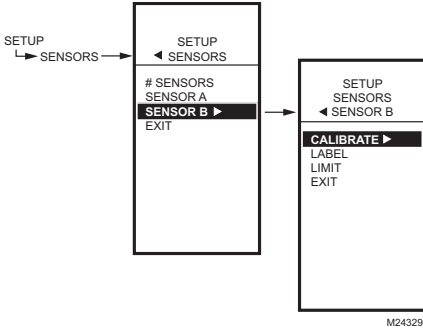

Fig. 50. Setup - Sensors - Sensor B Menu.

3.2.3. SENSOR B

For two-sensor reset control, Sensor B must always be the controlling temperature. For example, in a reset control based on outside temperature, Sensor B must be the outside sensor.

For the T775R2043 model only, which has a High/Low modulating temperature limit, the LIMIT item displays on the Sensor B menu.

1. From the Sensors menu, use the ▼ button to highlight SENSOR B.
2. Press the ▶ button to display the Sensor B menu.

3.2.3.1. CALIBRATE

Setting the calibration value is accomplished the same way as the Sensor A. Refer to “3.2.2.2. CALIBRATE (the sensor)” on page 20.

3.2.3.2. LABEL

Setting the label is accomplished the same way as the Sensor A. Refer to “3.2.2.3. LABEL (the sensor input)” on page 20.

Continue with “3.2.3.3. LIMIT (Sensor B only)”.

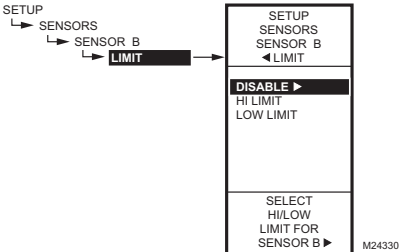

Fig. 51. Setup - Sensors - Sensor B - Limit.

3.2.3.3. LIMIT (Sensor B only)

For the T775R2043 model only, which has a High/Low modulating temperature limit, the LIMIT item displays on the Sensor B menu.

NOTE: The LIMIT option acts *only* on Modulating Output 1.

1. From the Sensors menu, use the ▼ button to highlight SENSOR B.
2. Press the ▶ button to display the Sensor B menu.
3. Use the ▲ and ▼ buttons to select the LIMIT item.
4. Use the ▶ button to display the Limit selections.
5. Use the ▲ and ▼ buttons to select the desired Limit (Disable, Hi Limit, or Low Limit).
Default: Disable
6. Press the ▶ button to accept the value and return to the Sensor B menu.

When you select Hi Limit or Low Limit, the Sensor B menu changes and adds the Hi/Low Limit and Throttling Range items.

If you are setting a Hi or Low Limit, continue with “3.2.3.3.1. HI LIMIT or LOW LIMIT (Sensor B only)” on page 22.

If you selected Disable for the Limit value, continue with “3.3.3. Setting up the Outputs” on page 22.

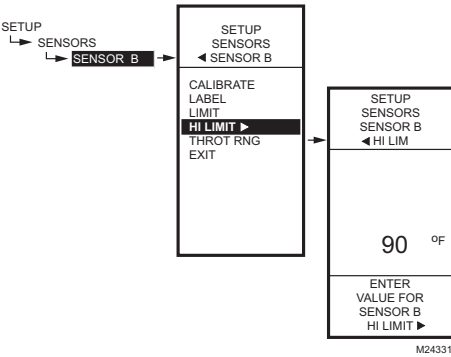

Fig. 52. Setup - Sensors - Sensor B - Hi/Low Limit (showing Hi Limit).

3.2.3.3.1. HI LIMIT or LOW LIMIT (Sensor B only)

Fig. 52 shows the Hi Limit, but the process is the same for setting the Low Limit. This applies to the T775R2043 model only.

Sensor B can be assigned a high/low limit, so that as you are controlling temperature at Sensor A, the control adjusts its modulating output to prevent exceeding the user-entered limit for Sensor B.

1. From the Sensor B menu, use the ▼ button to highlight HI LIMIT or LOW LIMIT.
2. Press the ► button display the LIMIT value.
3. Use the ▲ and ▼ buttons to increase/decrease the desired Limit value.
4. Press the ► button to accept the value and return to the Limit menu.

The high and low limit action will work in either the heat or cool mode as follows:

- When the low limit is used in the heat mode, the MOD1 output increases to prevent reaching the low limit at sensor B.
- When the high limit is used in the heat mode, the MOD1 output decreases to prevent reaching the hi limit at sensor B.
- When the low limit is used in the cool mode, the MOD1 output decreases to prevent reaching the low limit at sensor B.
- When the high limit is used in the cool mode, the MOD1 output increases to prevent reaching hi limit at sensor B.

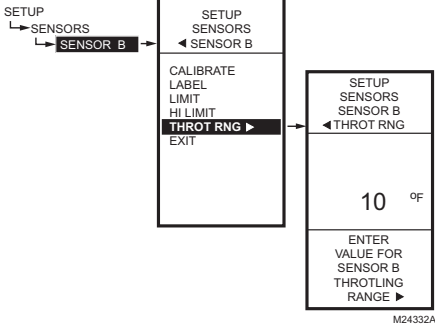

Fig. 53. Setup - Sensors - Sensor B - Throttling Range.

3.2.3.4. THROTTLING RANGE (Sensor B only)

The throttling range for the modulating high or low limit positions the setpoint at the end of the throttling range. For example, with a high limit at Sensor B of 200°F (93°C) and a throttling range of 10°F (-12°C), the modulating output controlling Sensor A begins to throttle back at 190°F (88°C), and fully closes at 200°F (93°C). Conversely, the throttling range for the low limit begins above the setpoint in the same manner.

1. From the Limit menu, use the ▼ button to highlight THROT RNG.
2. Use the ▲ and ▼ buttons to increase/decrease the desired value for the Throttling Range.
Default = 0
3. Press the ► button to accept the value and return to the Limit menu.
4. Press the ◀ button to exit the Limit menu.
5. Press the ◀ button to exit the Sensors menu and return to the Setup menu.

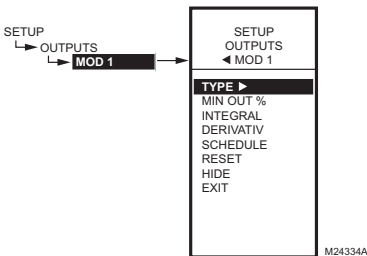

Fig. 54. Setup - Outputs Menu.

3.3.3. Setting up the Outputs

1. From the Setup menu, use the ▲ and ▼ buttons to highlight OUTPUTS.
2. Press the ► button to display the Outputs menu.

NOTE: The menus (e.g. the Outputs menu shown here) can display only those relays that are defined in Setup (Refer to “3.3.4. NBR OF RELAYS” on page 25). For example, if you configure only two relays, then only two relays display on the appropriate menus.

The following procedures set up each modulating output and relay output.

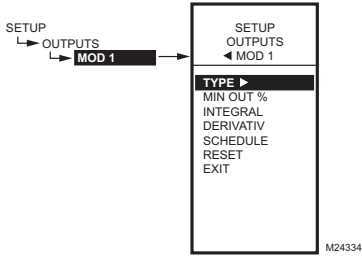

Fig. 55. Setup - Outputs - Modulating Output Menu.

3.3.3.1. Setting up the Modulating Outputs

1. From the Output menu, use the ▲ and ▼ buttons to highlight the desired modulating output (MOD 1 or MOD 2).
2. Press the ► button to display the selected MOD menu.

NOTE: Modulating outputs are not available on controller models T775R2001 and T775R2035. If you are setting up one of these controllers, skip to “3.3.4. NBR OF RELAYS” on page 25.

Use the remaining procedures, beginning with “3.3.3.1.1. TYPE (of output signal)”, to set up each modulating output. If you have two modulating outputs, repeat these procedures for each modulating output.

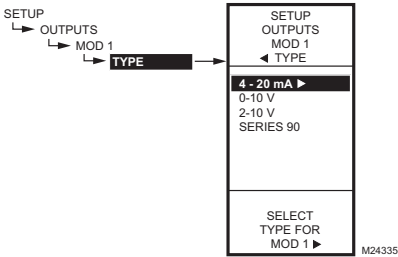

Fig. 56. Setup - Outputs - Mod Out - Type.

3.3.3.1.1. TYPE (of output signal)

1. From the Mod menu, use the ▲ and ▼ buttons to highlight TYPE.
2. Press the ► button to display the Type selections.
3. Use the ▲ and ▼ buttons to highlight the desired output type.
Default: 4-20 mA
4. Press the ► button to accept the selected type and return to the Mod menu.

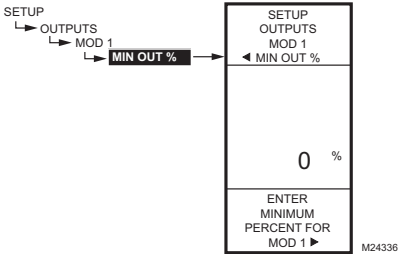

Fig. 57. Setup - Outputs - Mod Out - Minimum Output Percentage.

3.3.3.1.2. MIN OUT %

The minimum output % prevents the output from dropping below the value entered. This value can be useful to maintain minimum damper position.

Using the time clock or digital input to disable the output forces the output to 0%.

1. From the Mod menu, use the ▲ and ▼ buttons to highlight MIN OUT %.
2. Press the ► button to display the Min Out %.
3. Use the ▲ and ▼ buttons to increase/decrease the desired value from 0% to 100% in 1% increments.
Default: 0%
Range: 0 to 100%
4. Press the ► button to accept the percentage and return to the Mod menu.

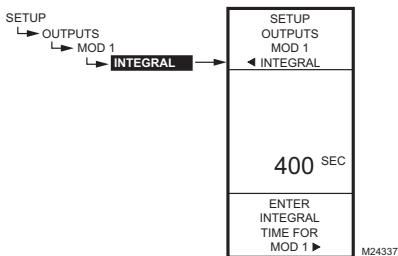

Fig. 58. Setup - Outputs - Mod Out - Integral.

3.3.3.1.3. INTEGRAL

1. From the Mod menu, use the ▲ and ▼ buttons to highlight INTEGRAL.
2. Press the ► button to display the Integral seconds.
3. Use the ▲ and ▼ buttons to increase/decrease the value from 0 to 3,600 in 10 second increments.
Default: 400 seconds
Range: 0 to 3,600 seconds
4. Press the ► button to accept the seconds and return to the Mod menu.

NOTES:

- a. The Integral time is factory set for 400 seconds and is similar to the response time to the T775J Series 1000 models. This is a good middle range and should satisfy many applications. The integral time can be increased for applications where sensed response is slow, and can be decreased for applications where sensed response is fast (e.g. discharge air control).
- b. As a starting point, an optimal integral time for discharge air typically ranges from 12 to 200 seconds. An optimal integral time for room control typically ranges from 60 to 2,500 seconds. The

purpose of integral action is to reduce or eliminate the offset from setpoint during steady state control that is often seen in proportional only control.

- c. Keep in mind that control is most sensitive to throttling range. Adjust the throttling range first before any adjustment to integral time. Adjust throttling range to be as wide as possible to start since this will provide the most stable control. Remember that the integral will eliminate the steady state error so you do not need to have a small throttling range to have accurate control. (Integral action allows for controlling to a setpoint even with a wide throttling range).

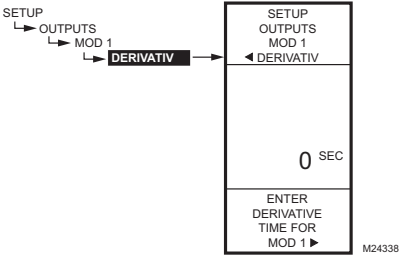

Fig. 59. Setup - Outputs - Mod Out - Derivative.

3.3.3.1.4. DERIVATIVE

The Derivative default value is factory set to zero (no derivative control). It is strongly recommended that the derivative remain at zero (0) unless you have a very good reason to adjust it. Derivative control is not needed in the vast majority of HVAC applications.

1. From the Mod menu, use the ▲ and ▼ buttons to highlight DERIVATIV.
2. Press the ► button to display the Derivative seconds.
3. Use the ▲ and ▼ buttons to increase/decrease the value.
Default: 0 (zero)
Range: 0 to 3,600 seconds
4. Press the ► button to accept the seconds and return to the Mod menu.

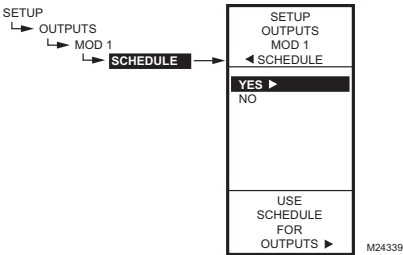

Fig. 60. Setup - Outputs - Mod Out - Schedule.

3.3.3.1.5. SCHEDULE

The Schedule option displays only if the USE SCHED parameter is set to Yes (Refer to Fig. 65 on page 26).

1. From the Mod menu, use the ▲ and ▼ buttons to highlight SCHEDULE.
2. Use the ▲ and ▼ buttons to highlight YES or NO.
Default: YES
3. Press the ► button to accept the selection and return to the Mod menu.

Each output can be set up to follow or ignore the built in scheduler. To disable the scheduler for all outputs, Refer to "3.3.5.1. USE SCHED" on page 26.

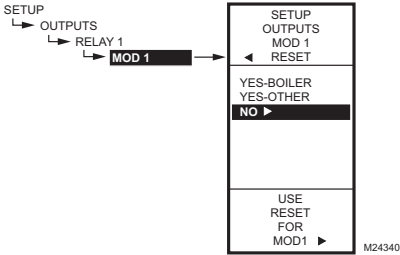

Fig. 61. Setup - Outputs - Mod Out - Reset.

3.3.3.1.6. RESET

This selection enables the controller's Reset function, and allows each output to be individually programmed for Reset or No Reset.

IMPORTANT

To use the Reset function of the controller, the first output (MOD1 or Relay 1 depending on the model) must be set for Reset here.

The RESET choice is offered for all outputs in setup mode, and you can set any or all of them for Reset=YES or Reset=NO. The default is Reset=NO.

For the remaining outputs, if Reset=YES, then these outputs use the reset curve programmed for the first output.

1. From the Mod menu, use the ▲ and ▼ buttons to highlight RESET.
2. Use the ▲ and ▼ buttons to highlight the desired value.
Default: NO
3. Press the ► button to accept the selection and return to the Mod menu.

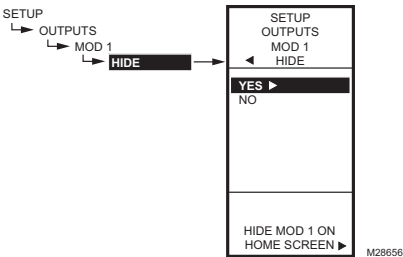

Fig. 62. Setup - Outputs - Mod 1/2- Hide.

3.3.3.1.7. Hide

The Hide option is used to prevent the MOD 1 and MOD 2 outputs from displaying on the Home screen.

1. From the Mod menu, use the ▲ and ▼ buttons to highlight HIDE.
2. Use the ▲ and ▼ buttons to highlight YES or NO.
Default: YES
3. Press the ► button to accept the selection and return to the MOD menu.

NOTE: The MOD1 and MOD2 outputs are still active even when hidden from the Home screen.

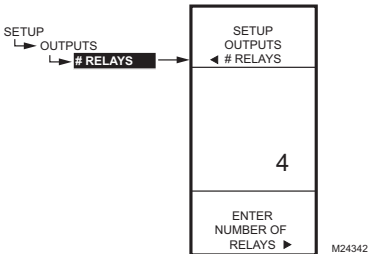

Fig. 63. Setup - Outputs - Number of Relays.

3.3.4. NBR OF RELAYS

1. From the Outputs menu, use the ▲ and ▼ buttons to highlight # RELAYS.
2. Press the ► button to display the number of relays.
3. Use the ▲ and ▼ buttons to display the number from 1 to 4 depending on the model. (See note below).
4. Press the ► button to accept the value and display the Outputs menu.

NOTES:

1. The T775R models have the following outputs available:
 - (a) T775R2001 up to 4 relay outputs
 - (b) T775R2019 up to 4 relay outputs
 - (c) T775R2027 up to 2 relay outputs
 - (d) T775R2035 up to 2 relay outputs
 - (e) T775R2043 no relay outputs
2. The number of relays entered here display on the home screen.

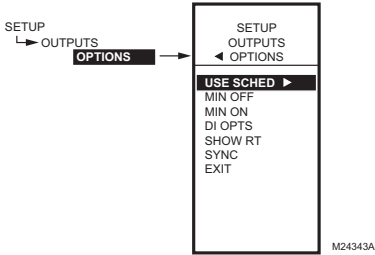

Fig. 64. Setup - Outputs - Options Menu.

3.3.5. OPTIONS

1. From the Outputs menu, use the ▲ and ▼ buttons to highlight OPTIONS.
2. Press the ► button to display the Options menu.

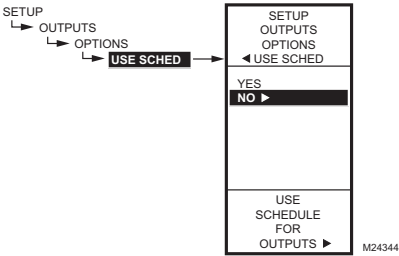

Fig. 65. Setup - Outputs - Options - Schedule.

3.3.5.1. USE SCHED

1. Press the ► button to display the schedule selections.
2. Use the ▲ and ▼ buttons to highlight YES or NO. Default: NO
3. Press the ► button to accept the value and display the MIN OFF option.

Selecting NO disables scheduling for **all** outputs.

Selecting YES enables scheduling for the setpoint. However, each individual output can be removed from scheduling as desired.

With Scheduling enabled, when you return to Program mode, the new option for Scheduling displays. You can press the HOME button and then the MENU button to view the Schedule options in the menu.

Refer to “3.3.3.1.5. SCHEDULE” on page 24.

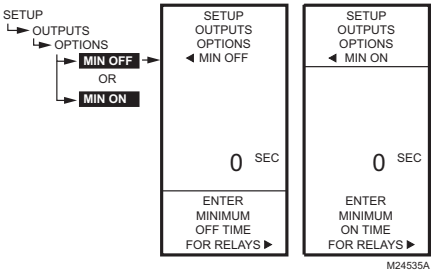

Fig. 66. Setup - Outputs - Options - Min Off/On Time.

3.3.5.2. MIN OFF or MIN ON

This is the minimum number of seconds of “off time” or “on time” for **all** relays.

1. Press the ► button to display the Min Off/On value.
2. Use the ▲ and ▼ buttons to increase/decrease the desired number of seconds from 0 to 990 seconds in 10 second increments. Default: 0 (zero) Range: 0 to 990 seconds
3. Press the ► button to accept the seconds and display the DI OPTIONS.

NOTES:

- a. The minimum off time applies to **all** relay outputs
- b. When minimum off time is active, relays waiting to be energized display a flashing square underneath the relay number on the home screen.
- c. If the minimum off time is not equal to zero (0), the minimum off time activates at power-up.
- d. To manually override, press the ◀ button at any time.

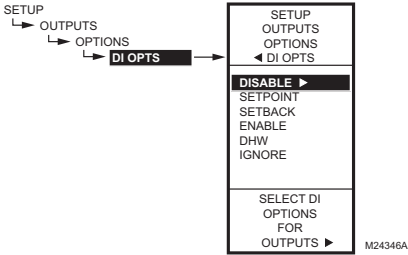

Fig. 67. Setup - Outputs - Options - DI Options.

3.3.5.3. DI OPTIONS (digital input options)

The DI Option you select applies to **all** outputs. This option overrides any Setpoint/Setback values entered in the Schedule.

1. Press the ► button to display the DI Option selections.
2. Use the ▲ and ▼ buttons to highlight DISABLE, SETBACK, or IGNORE.
Default: DISABLE
3. Press the ► button to accept the value and display the SHOW RT option.

When the digital input (DI) closes, all outputs follow the DI option value (Disable, Setback, or Ignore):

- **DISABLE** disables the outputs; relays return to de-energized state and Mod outputs return to 0% output.
- **SETPOINT** forces the control to the setpoint temperature
- **SETBACK** enables a setback temperature value to be programmed for each output and forces the control to the setback temperature.
 - To program the Setback temperature with Reset, Refer to Fig. 34 on page 15.
 - To program the Setback temperature without Reset, Refer to Fig. 43 on page 18.
- **ENABLE** energizes all relays and MOD outputs to 100%. Use this option carefully.
- **DHW:** If a reset curve is being used, then the controlled setpoint becomes the maximum setpoint (either SP MAX A1 or BOILR MAX). If a reset curve is not being used, then DI closure for DHW has no effect.
- **IGNORE** causes the digital input to have no effect on the Relay or Mod outputs.

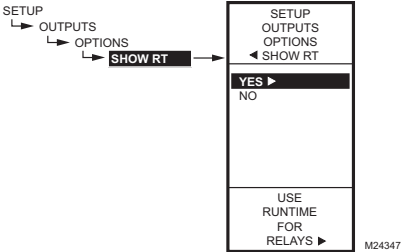

Fig. 68. Setup - Outputs - Options - Show Runtime.

3.3.5.4. SHOW RT (show run time hours)

1. Press the ► button to display the Show RT values.
2. Use the ▲ and ▼ buttons to select YES or NO.
Default: YES
3. Press the ► button to accept the value and return to the Options menu.

Selecting YES shows the RT (run time) hours for **each** relay on the home screen displays.

NOTE: Run times can be reset to zero for each individual relay. You must do this for each relay that you want to reset to zero. Refer to “3.3.6.4. RESET RT (run time)” on page 31.

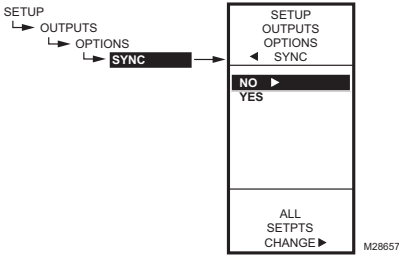

Fig. 69. Setup - Outputs - Options - Sync.

3.3.5.5 SYNC (synchronize setpoint changes)

1. Press the ► button to display the Sync values.
2. Use the ▲ and ▼ buttons to select YES or NO.
3. Default: NO
4. Press the ► button to accept the value and return to the Options menu.

Depending on the model, selecting YES causes all setpoints for all relays and MODs to sync to any change to:

- Relay 1 for models without MOD outputs
- MOD1 for models with MOD outputs

For example, assume the MOD1 setpoint is 110°F, MOD2 is 115°F, and Relay 1 is 120°F. With SYNC=YES, when the MOD1 setpoint is adjusted to 112°F (increase 2°F), then MOD2 and all other relay setpoints increase by 2°F. Thus the MOD2 setpoint is now 117°F and the relay 1 setpoint is 122°F.

3.3.5.6. Exit Options Setup

Press the ◀ button (or highlight EXIT and press the ► button) to exit and return to the Outputs menu.

Continue with “3.3.6. Setting up the Relays”

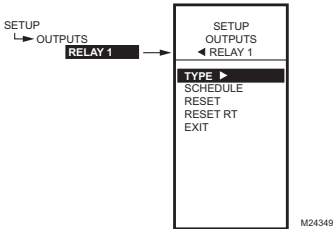

Fig. 70. Setup - Outputs - Relay Menu.

3.3.6. Setting up the Relays

1. From the Outputs menu, use the ▲ and ▼ buttons to highlight the desired relay (1-4 depending on model).
2. Press the ► button to display the selected relay menu.

The TYPE selection shown in Fig. 70 displays only for Relay 1 and Relay 3.

Continue with the remainder of this section to setup the relay outputs.

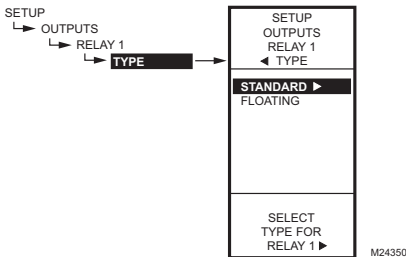

Fig. 71. Setup - Outputs - Relay - Type.

3.3.6.1. TYPE (standard or floating)

The Floating option is only available on the T775R2001 and the T775R2035 models.

For these models, this selection displays only for Relay 1 and/or Relay 3.

Press the ► button to display the Type values.

3. Use the ▲ and ▼ buttons to select STANDARD OR FLOATING.
Default: STANDARD (not floating)
4. Press the ► button to accept the value and return to the Relay menu.

- If you select FLOATING, the relays are paired (1-2 or 3-4) and are setup together. Continue with “3.3.6.1.1. Floating Relay Menu” on page 29.
- If you select STANDARD, go to “3.3.6.2. SCHEDULE” on page 30.

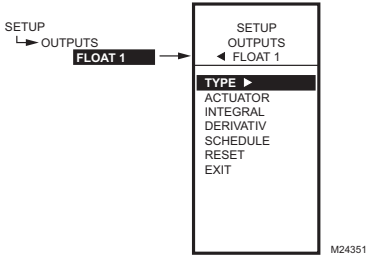

Fig. 72. Setup - Outputs - Floating Relay - Menu.

3.3.6.1.1. Floating Relay Menu

The Floating option is only available on the T775R2001 and the T775R2035 models.

When Relay 1 and/or Relay 3 is setup as floating, relays are paired and the Float 1 or Float 2 menu displays with the selections shown in Fig. 72.

Continue with “3.3.6.1.1.1. ACTUATOR (floating relay only)”.

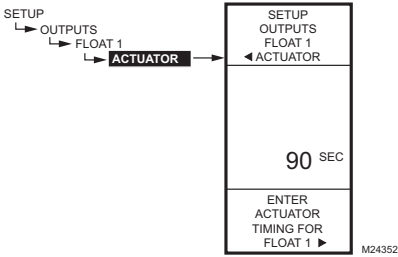

Fig. 73. Setup - Outputs - Floating Relay - Actuator.

3.3.6.1.1.1. ACTUATOR (floating relay only)

The Actuator option displays only on the T775R2001 and the T775R2035 models when the Type option = Floating.

1. From the menu, use the ▲ and ▼ buttons to highlight ACTUATOR.
2. Press the ► button to display the actuator value.
3. Use the ▲ and ▼ buttons to increase/decrease the desired number of seconds.
Default: 90 seconds
Range: 0 to 3,600 seconds
4. Press the ► button to accept the value and display the INTEGRAL option.

The actuator run time is defined as the time needed to move the actuator from the fully closed to fully open position and visa versa.

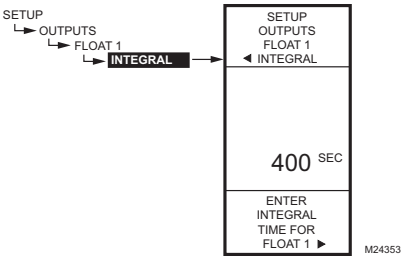

Fig. 74. Setup - Outputs - Floating Relay - Integral.

3.3.6.1.1.2. INTEGRAL (modulating/floating relay only)

The Integral option displays only on the T775R2001 and the T775R2035 models when the Type option = Floating.

1. From the menu, use the ▲ and ▼ buttons to highlight INTEGRAL.
2. Press the ► button to display the actuator value.
3. Use the ▲ and ▼ buttons to increase/decrease the desired number of seconds.
Default: 400 seconds
Range: 0 to 3,600 seconds
4. Press the ► button to accept the value and display the DERIVATIV option.

Refer to Integral NOTES on page 24 for additional information about setting the Integral time.

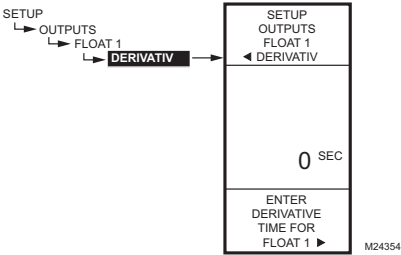

Fig. 75. Setup - Outputs - Floating Relay - Derivative.

3.3.6.1.1.3. DERIVATIV (modulating/floating relay only)

The Derivative option displays only on the T775R2001 and the T775R2035 models when the Type option = Floating.

1. From the menu, use the ▲ and ▼ buttons to highlight DERIVATIV.
2. Press the ► button to display the actuator value.
3. Use the ▲ and ▼ buttons to increase/decrease the desired number of seconds.
Default: 0 seconds
Range: 0 to 3,600 seconds)
4. Press the ► button to accept the value and display the SCHEDULE option.

Continue with "3.3.6.2. SCHEDULE" for the remaining relay selections.

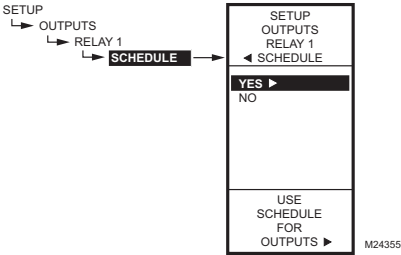

Fig. 76. Setup - Outputs - Relay - Schedule.

3.3.6.2. SCHEDULE

This selection displays only if "Use Sched = YES" is selected during the Output Options setup (Refer to "3.3.5. OPTIONS" on page 26). When selected, individual outputs default to follow the schedule.

1. Press the ► button to display the Schedule values.
2. Use the ▲ and ▼ buttons to select YES or NO.
Default: YES
3. Press the ► button to accept the value and return to the Relay menu.

An individual output can be selected to be controlled or not controlled by the schedule.

If NO is selected, the Setback selection does not appear in the Program menu for this output.

CONTROLLERS WITH MODULATING OUTPUTS

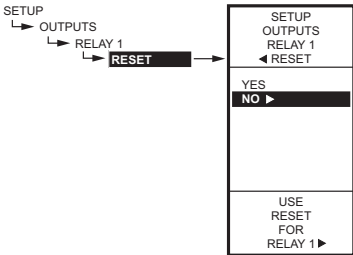

CONTROLLERS WITH NO MODULATING OUTPUTS

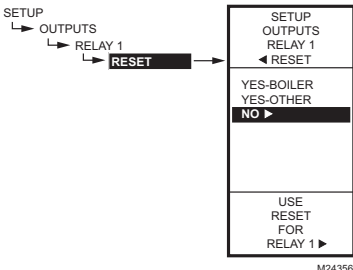

Fig. 77. Setup - Outputs - Relay - Reset.

3.3.6.3. RESET

The Reset menu displayed (Fig. 77) depends on whether the controller has modulating outputs:

- For controllers with modulating outputs, the first output (MOD 1) is settable for Reset, which then enables Reset to be set for the Relay outputs. Refer to "3.3.3.1.6. RESET" on page 25.
- For controllers with no modulating outputs, this selection enables the controller's Reset function, and allows each relay output to be individually programmed for Reset or No Reset.

IMPORTANT

To use the Reset function of the controller, the first output (MOD 1 or Relay 1 depending on the model) must be set for Reset.

1. Press the ► button to display the Reset values.
 2. Use the ▲ and ▼ buttons to select YES or NO.
Default: NO
 3. Press the ► button to accept the value and return to the Relay menu.
- If you select YES, then all other outputs display this Setup option and will use the reset curve programmed for the first output.
 - If you select NO, then No Reset is configured for that output and all other subsequent outputs.

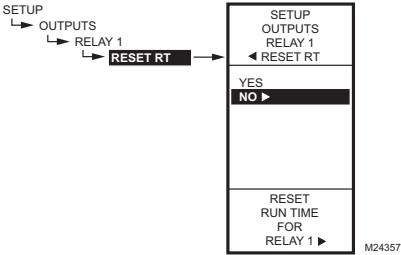

Fig. 78. Setup - Outputs - Relay - Reset Runtime.

3.3.6.4. RESET RT (run time)

This selection displays only if “Show RT = YES” is selected during Output Options setup (Refer to “3.3.5.4. SHOW RT (show run time hours)” on page 27).

1. Press the ► button to display the Reset RT values.
2. Use the ▲ and ▼ buttons to select YES or NO. Default: NO
3. Press the ► button to accept the value and return to the Relay menu.

Selecting YES immediately resets the output run time hours to zero for this output. When you subsequently return to this screen, the RESET RT defaults to NO.

NOTE: Run times can be reset to zero for each individual relay. You must do this for each relay that you want to reset to zero.

3.3.7. Setup the Next Relay

To setup the next relay output go to “3.3.6. Setting up the Relays” on page 28.

3.4. Exiting Setup

Press the ◀ button to exit the selected relay set up and return to the Outputs menu.

If you are finished setting up the relay outputs, press the HOME button to exit Setup mode and return to the home screen display.

This completes the Setup procedure.

4. SCHEDULING

Scheduling provides the ability to set daily temperature settings for up to two events per day. Typically, these are the daytime (setpoint) and the nighttime (setback) settings.

IMPORTANT

To enable Scheduling, you must first enter Setup mode (press and hold the MENU button for 5 seconds), select OUTPUTS, select OPTIONS, select USE SCHED, and then select YES. (Refer to “3.3.5.1. USE SCHED” on page 26).

IMPORTANT

To properly account for Daylight Saving time, be sure to set the Date before setting the Time. Refer to “4.2.2. SET DATE” on page 33.

NOTE: The T775R controller interface is intuitive. You may find that you do not need the following scheduling instructions. You may want to use this procedure simply as a reference to locate the particular option or parameter of interest.

NOTE: Each output is independently configurable to follow the schedule or not. For modulating outputs, Refer to “3.3.3.1.5. SCHEDULE” on page 24. For relay outputs, Refer to “3.3.6.2. SCHEDULE” on page 30.

NOTES:

1. If you press the HOME button or there is no keypad activity for four minutes, you exit Scheduling mode and return to the home screen.
2. If you press the MENU button, you exit Scheduling mode and return to the menu.

To create or change a schedule, you use the —

- **Left arrow button (◀)** to scroll backward through the Schedule menus
- **Right arrow button (►)** to select the highlighted menu item and display its content
- **Up and Down arrow buttons (▲ and ▼)** to scroll up and down through a list of items or to increase or decrease the value of a displayed schedule parameter

Creating a Schedule

To create a schedule, perform the following in the order listed:

1. Enable Scheduling in Setup mode - Refer to "3.3.5.1. USE SCHED" on page 26
2. Enter Schedule mode — see "4.1. Entering Schedule Mode"

3. Set the Schedule Options — see "4.2. OPTIONS"
4. Set Individual Schedules — begin with "4.3. Setting Individual Schedules" on page 33
5. Exit Schedule Mode — refer to "4.4. Exiting Scheduling Mode" on page 34

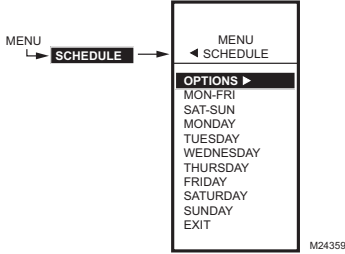

Fig. 79. Schedule - Menu.

4.1. Entering Schedule Mode

Press the **MENU** button, then select **SCHEDULE** and press the **▶** button to view the Schedule menu.

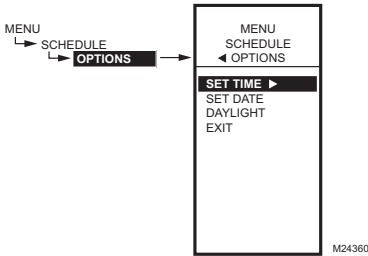

Fig. 80. Schedule - Options Menu.

4.2. OPTIONS

1. From the Schedule menu, use the **▲** and **▼** buttons to highlight **OPTIONS**.
2. Press the **▶** button to display the Options menu.

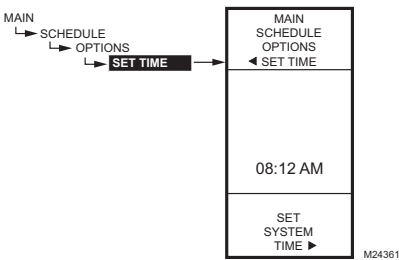

Fig. 81. Schedule - Options - System Time.

4.2.1. SET TIME

Setting the system time is required to enable the controller to follow daylight saving time.

IMPORTANT

*Set the Date **before** setting the Time. See "4.2.2. SET DATE" on page 33.*

1. From the Options menu, use the **▲** and **▼** buttons to highlight **SET TIME**.
2. Press the **▶** button to display the current system time setting.
3. Use the **▶** button to cycle between the hour, minute, and AM/PM values.
4. Use the **▲** and **▼** buttons to increase/decrease the desired value for the hour, minute, and AM/PM.
5. Press the **◀** button to accept the Time and return to the Options menu.

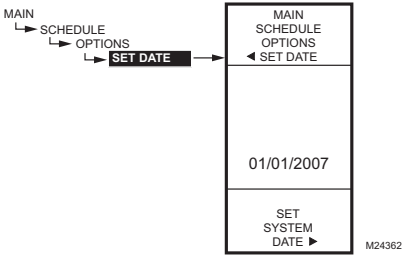

Fig. 82. Schedule - Options - System Date.

4.2.2. SET DATE

Setting the system date is required to enable the controller to follow daylight saving time.

IMPORTANT

*To properly account for Daylight Saving time, be sure to set the Date **before** setting the Time.*

1. From the Options menu, use the ▲ and ▼ buttons to highlight SET DATE.
2. Press the ► button to display the current system date setting.
3. Use the ► button to cycle between the month, day, and year values.
4. Use the ▲ and ▼ buttons to increase/decrease the desired value for the month, day, and year.
5. Press the ◀ button to accept the Date and return to the Options menu.

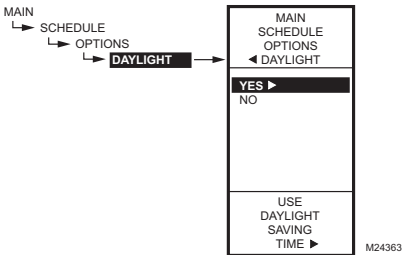

Fig. 83. Schedule - Options - Daylight Saving Time.

4.2.3. DAYLIGHT (daylight saving time)

1. From the Options menu, use the ▲ and ▼ buttons to highlight DAYLIGHT.
2. Press the ► button to display the current system setting for daylight saving time.
3. Use the ▲ and ▼ buttons to select YES or NO. Default: YES
4. Press the ► button to accept the value and return to the Options menu.
5. From the Options menu, use the Use the ▲ and ▼ buttons to highlight EXIT.
6. Press the ► button to return to the Schedule menu.

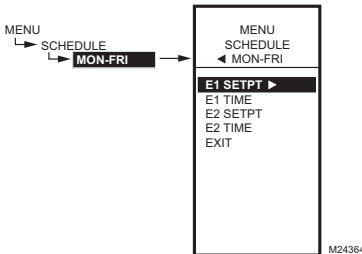

Fig. 84. Schedule Event Menu (Showing MON-FRI).

Table 5. Mon - Fri Schedule Defaults

DAY	EVENT	SETPT ACTION	TIME
Mon-Fri	Event 1 (E1)	Setpoint	6:00 AM ^a
Mon-Fri	Event 2 (E2)	Setback	6:00 PM ^b
Sat-Sun	Not used; remains in Setback from Mon-Fri E2 settings		

^a Setpoint time span is 6:00 AM until 5:59 PM because setback starts at 6:00 PM.

^b Setpoint time span is 6:00 PM until 5:59 AM because setback starts at 6:00 PM.

4.3. Setting Individual Schedules

As shown in the Schedule menu (Fig. 79 on page 32), schedules can be set for the following time periods:

- Monday through Friday
- Saturday and Sunday
- Individual days of the week

1. From the Schedule menu, use the ▲ and ▼ buttons to highlight the desired time period.
2. Press the ► button to display the Schedule menu for the selected time period.

SCHEDULING EXAMPLE

Setting the schedule is independent of the temperature settings for the relay outputs. Table 5 illustrates a weekly schedule for the relay outputs. Table 5 illustrates a weekly schedule for daytime (setpoint) and night time (setback) use and shows the factory default settings.

For each selected time period, the schedule event (E1 and E2) parameters are exactly the same as shown in Fig. 84.

To set a schedule, continue with “4.3.1. E1 SETPT (setpoint for event 1)” on page 34.

The following figures show the MON-FRI menu, but the menu selections are the same for any time period.

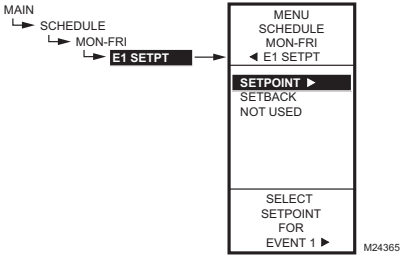

Fig. 85. Schedule - Event 1 Setpoint.

4.3.1. E1 SETPT (setpoint for event 1)

1. From the selected time period menu, use the ▲ and ▼ buttons to highlight E1 SETPT.
2. Press the ► button to display the setpoint options.
3. Use the ▲ and ▼ buttons to highlight the desired option.
4. Press the ► button to accept the value and return to the selected time period menu.

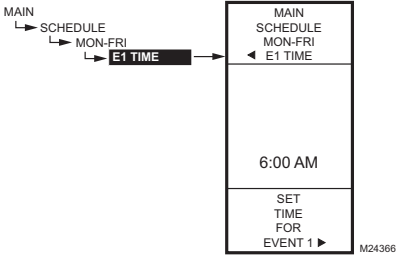

Fig. 86. Schedule - Event 1 Time.

4.3.2. E1 TIME (time for event 1)

1. From the selected time period menu, use the ▲ and ▼ buttons to highlight E1 TIME.
2. Press the ► button to display the current time setting for event 1.
3. Use the ► button to cycle between the hour, minute, and AM/PM values.
4. Use the ▲ and ▼ buttons to increase/decrease the desired value for the hour, minute, and AM/PM.
5. Press the ◀ button to accept the time and return to the selected time period menu.

4.3.3. E2 SETPOINT (setpoint for event 2)

Creating the setpoint for event 2 is accomplished the same way as the first event. Refer to "4.3.1. E1 SETPT (setpoint for event 1)" on page 34.

4.3.4. E2 TIME (time for event 2)

Creating the time for event 2 is accomplished the same way as the first event. See "4.3.2. E1 TIME (time for event 1)" above.

4.3.5. EXIT (exit from selected time period settings)

After entering the time for event 2, use the ◀ button to exit the schedule time period and return to the Schedule menu to select a different time period.

When you finish scheduling the time periods, continue with "4.4. Exiting Scheduling Mode".

4.4. Exiting Scheduling Mode

Press the HOME button to exit the Schedule menu and return to the home screen display.

or

Press the ◀ button to return to the menu, then use the ▲ and ▼ buttons to highlight EXIT from the menu and press the ► button.

This completes the Scheduling procedure.

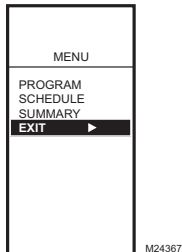

Fig. 87. Scheduling Mode Exit.

SUMMARY MENU

The Summary menu provides the ability to view the schedule (E1 and E2 times) for each relay for each day of the week.

NOTE: Scheduling must be enabled for the Summary menu to display. Enabling the schedule is determined in the Setup process for the Output Options (Refer to “3.3.5. OPTIONS” on page 26).

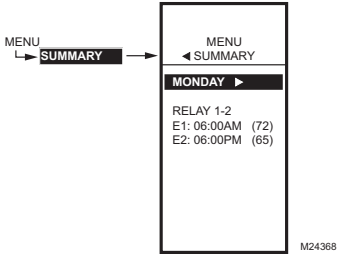

Fig. 88. Summary Example - Monday Settings.

For each relay, the Summary display indicates the time and temperature (in parenthesis) for each of the two scheduled events E1 and E2.

1. Press the **MENU** button, then select **SUMMARY** and press the **▶** button to view the summary settings.
2. Use the **▶** button to scroll forward through each day of the week (Monday, Tuesday, Wednesday, Thursday, Friday, Saturday, and Sunday).
3. While viewing a specific day, use the **▲** and **▼** buttons to cycle through the individual relay schedules for that day.

When finished, press the **HOME** button to return to the home display screen.

If programmed for Reset control, the Summary setpoints display as “RES” instead of a temperature value. For example, the display would show:

```

MONDAY
STAGES
E1: 06:00AM (RES) - indicating Reset
E2: 06:00PM (05) - setback/offset degrees
  
```

TROUBLESHOOTING

Power Loss

The date and time settings are retained for 24 hours after a power outage. After a power loss of more than 24 hours, the date and time settings may need to be reentered. All other settings are stored permanently.

Errors and Diagnostics

The controller provides an error message and diagnostic status as described below.

Error Message

There is a two-character error code that displays in response to controller software problems:

EE

EEPROM Failure — The values read back from the EEPROM are not the same as written into the EEPROM. This error cannot be field repaired. Replace the device.

Diagnostic Messages

There are two diagnostic messages that can display in response to sensor problems. The diagnostic codes that can flash on the display are:

--

Sensor Open or Shorted — Two dashes display when a sensor (typically temperature) is open or shorted. An open circuit is considered anything greater than 1570 ohms (greater than 300 F (149° C)), shorted anything less than 770 ohms (less than -73 F (23° C)). Whichever stages are operating with this sensor cease to control (meaning relays go to OFF and proportional outputs go to zero percent).

This message can also mean that the sensor is programmed, but not physically connected.

-60° or 270° F (-51° or 132° C) Blinking

Temperature Out of Range — The temperature display blinks when the sensed temperature range is outside of the display range, below -60° F (-51° C) or above 270° F (132° C). The displayed value remains at that displayed limit and control continues. Controller continues to function unless an open or shorted state is detected.

Blinking relay status

Relay Minimum Off Time is Active — On the home screen, each relay's indicator (■) blinks while the relay's minimum off time is active.

SPECIFICATIONS

Power: 24, 120, or 240 Vac; 50/60 Hz.
A separate earth ground is required for any power source.

Power Consumption:

- 8 VA maximum at 60 Hz
- 10 VA maximum at 50 Hz

Operating & Storage Temperature Ambient Rating:

- -40° to 125° F (-40° to 52° C) @ 50 Hz
- -40° to 140° F (-40° to 60° C) @ 60 Hz

Relative Humidity: 5% to 95% non-condensing

Relay Contact Output Ratings (N.O. and N.C.):

- 1/2 hp; 9.8 AFL, 58.8 ALR @ 120 Vac
- 1/2 hp; 4.9 AFL, 29.4 ALR @ 240 Vac
- 125 VA pilot duty @ 120/240 Vac
- 10A @ 24 Vac (resistive)

Modulating Outputs:

- 0-10 Vdc; drive a minimum of 2,000 Ohms
- 2-10 Vdc; drive a minimum of 2,000 Ohms
- 4-20 mA; drive a maximum of 600 Ohms
- Electronic Series 90
- Floating

DOC

Emissions Compliance

EN 55022: 2006
CISPR 22: 2006
VCCI V-3/2006.04
ICES-003, Issue 4: 2004
FCC PART 15 SUBPART B Class B Limit

Immunity Compliance

EN 61000-6-1: 2001 covering
EN 61000-4-2: 1995 + A1: 1998 + A2: 2001
EN 61000-4-3: 2002
EN 61000-4-4: 2004
EN 61000-4-5: 1995 + A1: 2001
EN 61000-4-6: 1996 + A1: 2001
EN 61000-4-8: 1993 + A1: 2001
EN 61000-4-11 2nd Ed.: 2004

Safety Compliance

UL 60730-1 for US and Canada

FCC Compliance Statement:

This equipment has been tested and found to comply with limits for a Class B digital device, pursuant to Part 15 of the FCC rules. These limits are designed to provide reasonable protection against harmful interference in residential installations. This equipment generates, uses, and can radiate radio frequency energy, and if not installed and used in accordance with the instructions, may cause harmful interference to radio communications.

However, there is no guarantee that interference will not occur in a particular installation. If this equipment does cause interference to radio or television equipment reception, which can be determined by turning the equipment off and on, the user is encouraged to try to correct the interference by one or more of the following measures:

- Reorient or relocate the receiving antenna
- Move the equipment away from the receiver
- Plug the equipment into an outlet on a circuit different from that to which the receiver is connected
- Consult the dealer or an experienced radio/television technician for additional suggestions

You are cautioned that any change or modifications to the equipment not expressly approve by the party responsible for compliance could void Your authority to operate such equipment.

This device complies with Part 15 of the FCC Rules. Operation is subjected to the following two conditions 1) this device may not cause harmful interference and 2) this device must accept any interference received, including interference that may cause undesired operation.

By using this Honeywell literature, you agree that Honeywell will have no liability for any damages arising out of your use or modification to, the literature. You will defend and indemnify Honeywell, its affiliates and subsidiaries, from and against any liability, cost, or damages, including attorneys' fees, arising out of, or resulting from, any modification to the literature by you.

Automation and Control Solutions

Honeywell International Inc.
1985 Douglas Drive North
Golden Valley, MN 55422
customer.honeywell.com

© U.S. Registered Trademark
© 2014 Honeywell International Inc.
62-0249—13 M.S. Rev. 04-14
Printed in United States

Honeywell