

148

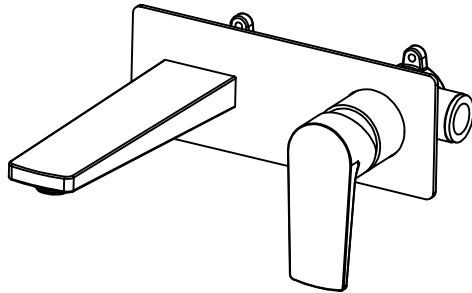

Wall Mounted Bath/ Basin Mixer Installation Instructions



Precautions

1. Flush the impurities in the water supply pipeline
2. Check the water supply pipes for damage
3. Working pressure 0.05-1.0Mpa
4. Water temperature 0-90°C, suggest water temperature 0-65°C

Aftercare Instruction

Clean this item with a soft cloth or sponge. The use of any abrasive cleanser may have chemical reaction with the surface and will invalidate the guarantee.

INSTALLATION DIMENSIONS

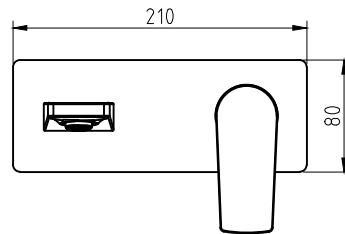
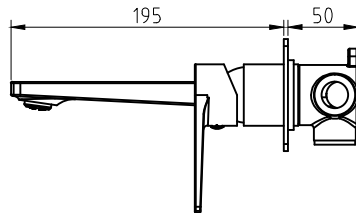

Installation Steps

1. Wall slotting size

The depth of the wall from the front end to the bottom is 50mm, the maximum length is 200mm and the maximum width is 70mm

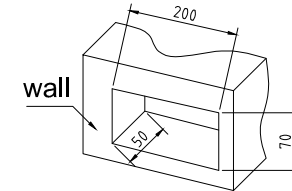

2. Install the tap valve body

- a) Screw two exchange adapters (No.4) on the inlet of valve body (No.2), use wrench to tighten it.
- b) First, use an electric drill to drill holes in the wall according to the position of the positioning hole of the valve body, then install the expansion screw (NO.1) into the wall, install the valve body (No.2) into the wall, connect the cold and hot water pipes, and finally fix the valve body with screws (No.3)

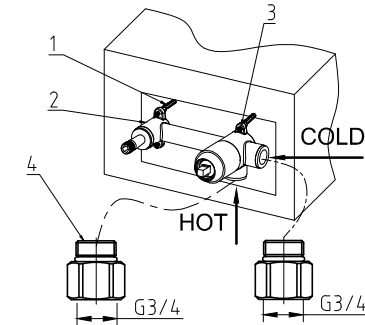

3. Install the panel

Before installing the panel, turn on the water supply first, and check whether there is water leakage at the connection between the valve body and the pipe. After ensuring that there is no leakage, then put the panel (NO.5) on the valve body

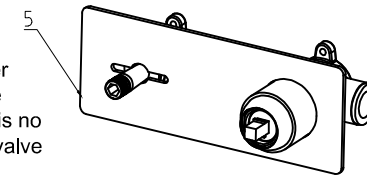

4. Handle and Spout installation

Install Handle: Remove the No.7 from Handle (No.6), then install the handle on the valve body, tighten the screws with wrench (No.8 & No.9)

Install Spout: Insert the spout (NO.10) and tighten it with the wrench (No.8 & No.11)

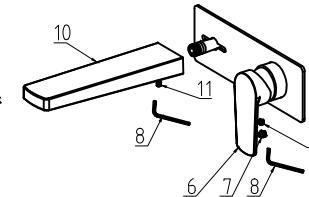

210