

In-Line Air Separators

The AC models of air separators deliver all the quality and performance you expect from Taco products. They are built to last with shell, heads and ANSI flanges with ASME constructed for 125, 150, 250 and 300psi working pressures all while providing outstanding performance in the field, up to a maximum operating temperature of 375°F. The AC product line is available in standard sizes from 2" through 20" to meet the needs of a broad range of applications with custom unit sizes available up to 36" pipe size.



Features & Benefits

Air trapped in the system can produce major problems such as reduced heat transfer, loss of system efficiency, pipe corrosion, pump damage, increased energy consumption and irritating noise. The highly efficient Taco air separator clears the system of free air and reduces un-dissolved sediment to save money, energy and component wear. Unlike many competitive models each unit is designed, constructed and tested to the requirements of Section VIII, Division I of the ASME pressure vessel code as standard.



Designed for use in hydronic heating or cooling systems, Taco's compact, highly efficient air

separator provides air separation while minimizing space requirements.

Taco offers these separators with or without strainers, in standard pipe line sizes from 2" to 20" with custom unit sizes up to 36" pipe size. The wide range of separator models have been developed for applications with flowrates up to 12,500 gpm. This wide range of models allows optimum selections with reduced pressure drop requirements. The standard product is designed for working pressures of 125 psi at 375°F. Optional 150, 250 and 300 psi maximum pressure units, 375°F maximum temperature units are also available. Taco air separators are manufactured from carbon steel listed in ASME Section II. Consult the factory for higher working pressures, larger sizes or non-standard materials of construction.

Air Separator Flow Pattern

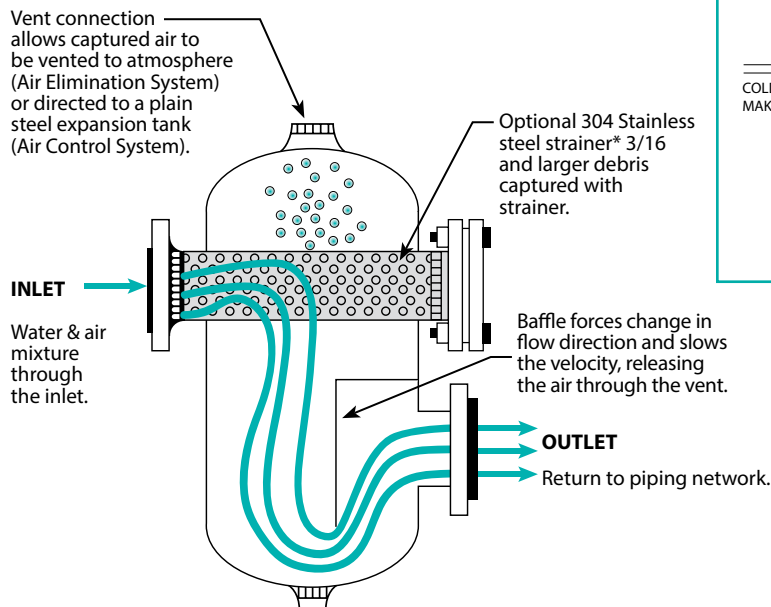

* Provided as standard on F model units

Recommended/Typical Installation

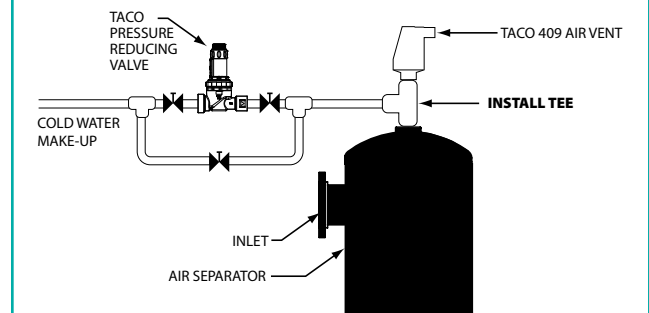

In-Line ASME Air Separators (AC)

Taco In-Line Air Separators are applied in commercial, institutional and industrial applications for the removal of free air in water or water/glycol systems. The In-Line designed air separator utilizes the advantages resulting from large body diameter in relation to the entering nozzle diameter.



The design of in-line air separators depends upon the **lowering of the system fluid velocity** within the separator, the **change in direction** of fluid flow within the unit, and **buoyant force** direct air to the automatic air vent normally positioned at the top of the separator.

These air separators are designed, built and stamped to the requirements of ASME. The rated working pressure of these units is dependent upon the design pressure of the hydronic system into which they are being installed. Manufacturers offer these unit working pressures of 125, 150, 250 and 300 psi and higher if required.

Optional stainless steel strainers are specified to **capture** and allow the removal of larger debris. (3/16" and larger) These screens are normally specified with 3/16 inch perforations and free area of not less than 5 times the open area of the nozzle to minimize pressure drop. Most manufacturers provide a blowdown connection at the bottom of the unit.

When In-Line Air Separators are installed in conventional **Air Control Systems** with plain steel expansion tanks (Figure A) care must be taken to insure that piping between the air separator and the plain steel expansion tank is pitched at least 3 degrees to facilitate the migration of captured air back into the expansion vessel. Systems with plain steel expansion tanks must not have automatic vents installed as this will lead to the loss of the expansion tank compression cushion.

Air Separator with Plain Steel Expansion Tank

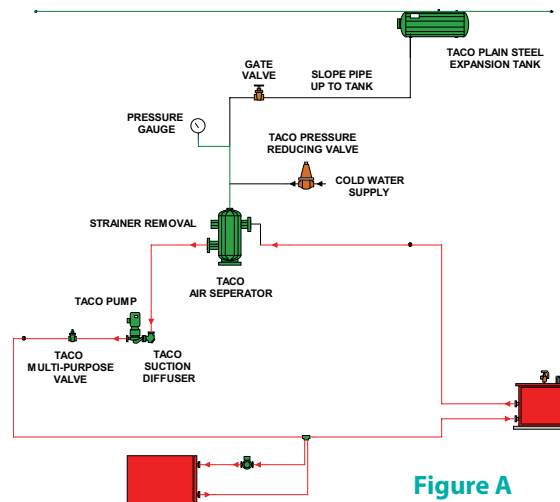

Figure A

When In-Line Air Separators are installed in **Air Elimination Systems** (Figure B) with Captive Air bladder or diaphragm style expansion tanks, automatic air vents should be installed at the top of each separator. As Air Elimination systems have a permanent separation provided by the bladder or diaphragm between the initial tank pre-charge and the system fluid no loss of pre-charge air will occur.

Applications

- Larger systems
- Lower pressure drop
- Removal of larger particles

Air Separator with Captive Air Tank

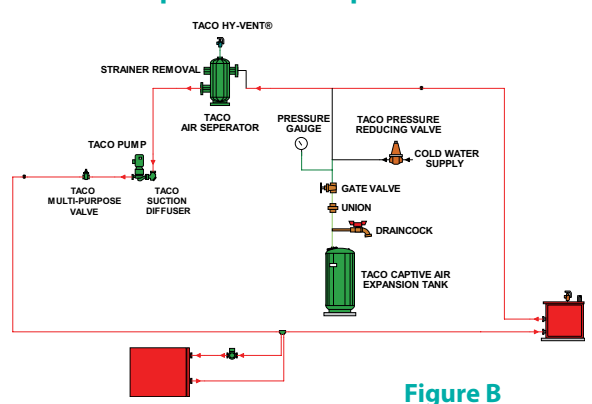

Figure B

Applications

Air Control and Elimination

Water contains a certain amount of entrained air. If this air comes out of solution, it can increase corrosion rates of metals within the system. In addition, air can form pockets at the top of pipes and heating units. These air pockets can actually restrict or block flow in a hydronic piping system. This is referred to as "air locking".

The table below shows a solubility curve for air in water. Note that at a fixed pressure, increasing the temperature reduces the amount of air that can be dissolved. For example, at 60 PSIA and 40°F, the water can contain just over 10% air by volume. At 60 PSIA and 200° F, the percentage decreases to just over 4%.

Conversely, at fixed temperature reducing the pressure reduces the amount of air that can be dissolved. For example at 100°F and 80 PSIA the water can contain 8% air by volume. At 100°F and 20 PSIA the percentage decreases to 2%.

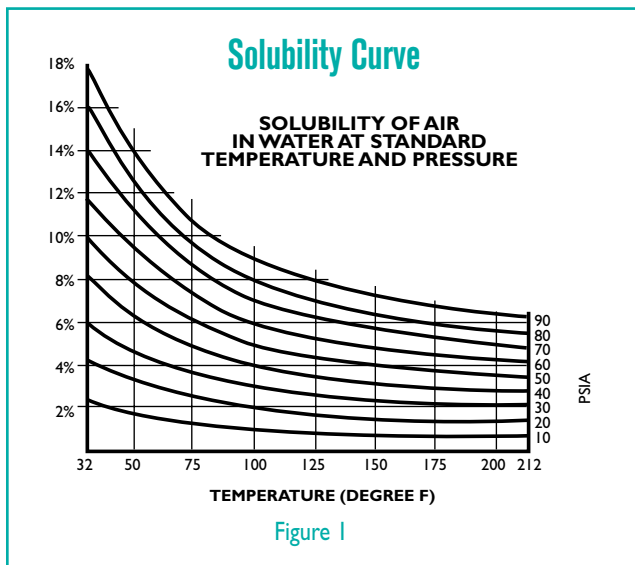

The conclusion is that air is least soluble in water at the highest temperature and lowest pressure. Air separators should therefore be located at these points.

The highest temperature in a system is typically on the discharge of boilers and inlet of chillers. Therefore, the general rule of thumb in hydronic systems is that **"Air separators should be located downstream of boilers (Figure 2) and upstream of chillers (Figure 3)."**

The lowest pressure in a system is typically at the expansion tank, since this is the point of no pressure change and the location of the fill valve. Therefore, the general rule of thumb in hydronic systems is that **"Air separators should be located at the expansion tank connection to the system."**

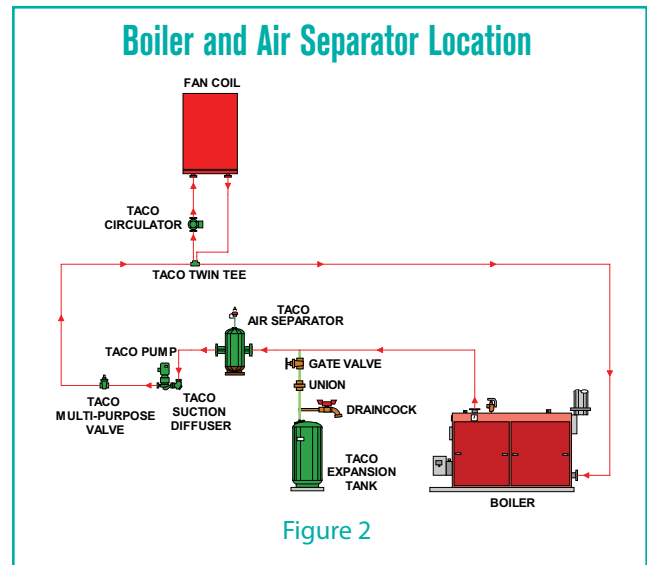

Figure 2

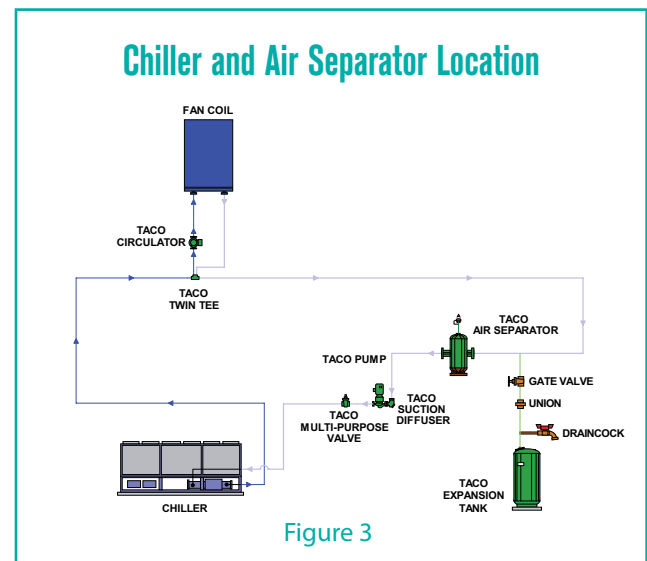

Figure 3

In addition, as water is heated from the fill temperature to the operating temperature, a great deal of air is released. Therefore, the simple act of bringing the water to operating temperature could lead to corrosion and air pockets, both of which should be avoided.

A method of removing this released air from the piping system is therefore required. Enter the air separator. An air separator is a device that removes the air from the circulating fluid.

There are several types of air separators in use today. Depending upon the type of expansion tank used in the system, the air separator is part of an Air Control System or an Air Elimination System.

Air Control Systems

If a conventional (non-bladder) style expansion tank is used, it is desirable to redirect the separated air to the space above the water level in the expansion tank (Figure 4). The dotted line from the air separator (scoop) to the plain steel tank shows the proper connection, with the air piped from the scoop to the expansion tank through a special tank fitting.

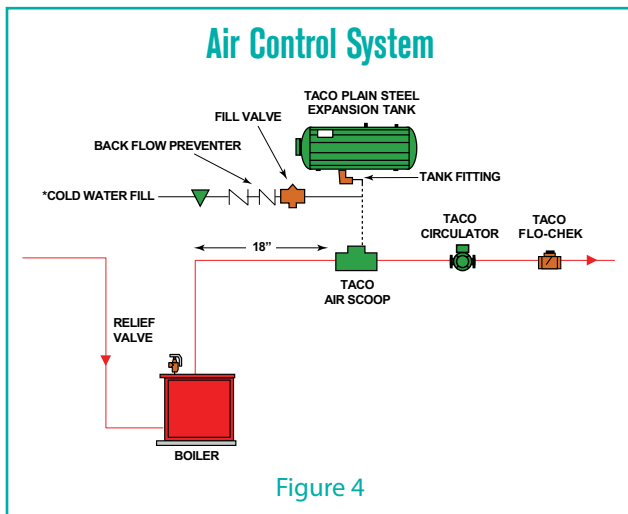

This fitting directs the air to the top portion of the tank, and discourages air from migrating back into the system (See Figure 5), when the system cools on the "off" cycle. Note that since the air is "recycled" to provide a cushion in the expansion tank, this system is called an "Air Control" system.

Note that the circulator is on the supply side of the boiler. This is the proper location, as it results in the highest pressure at the top of the system (if the circulator was on the return side of the boiler, the boiler pressure drop reduce the pressure at the top.) Having a higher pressure at the top keeps air in solution, and helps prevent problems and air binding.

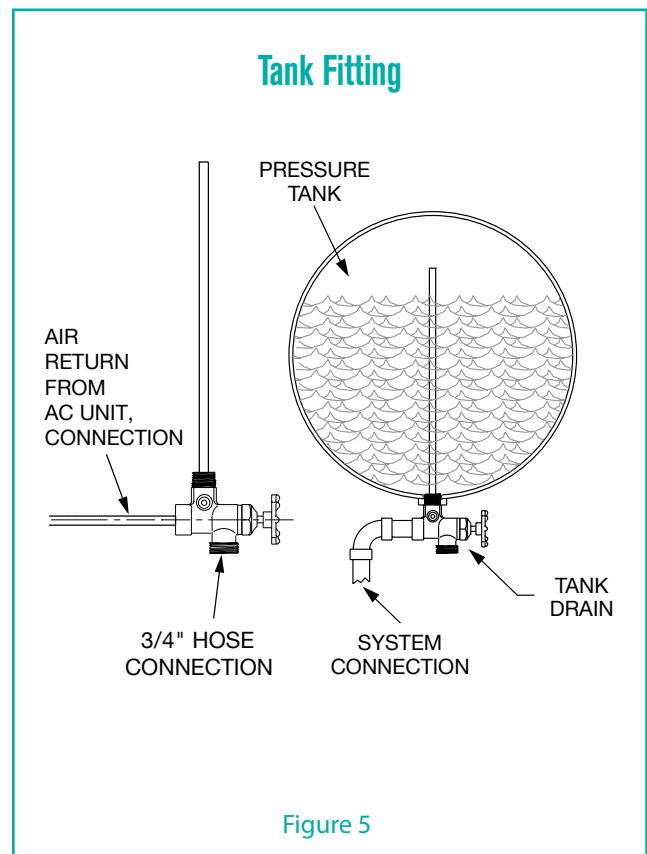

Applications

Air Elimination Systems

If a Captive Air or Bladder Style expansion tank is used, there is no reason to “save” the separated air (Figure 6). Therefore, if an air separator (scoop) is used in an air elimination system rather than an air control system, the separator is fitted with an automatic air vent (Taco’s “Hy-Vent®” series), which discharges the separated air to the atmosphere. Note that since the air is eliminated through an air vent this system is called an “Air Elimination” system.

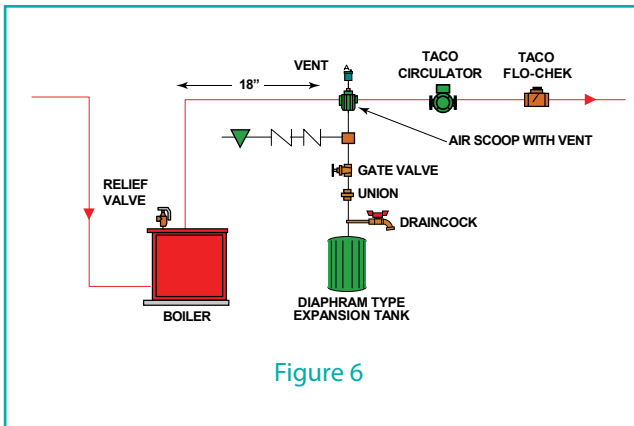

Figure 6

Types of Air Separators

Air Scoop

Taco Air scoops are applied in residential and light commercial applications for the removal of free air in water or water/glycol systems. The body of each air scoop provides an increased cross sectional area and lower velocity within the piping network thereby allowing free air to rise due to buoyant force. To assist with the removal of smaller air bubbles integral baffles are incorporated within most air scoops.



Optimum performance is achieved at line velocities up to 4 ft/sec. However, air scoops have been successfully installed on applications with velocities up to 8 ft/sec. Air scoops are specifically designed for the line size which they are to be installed. These sizes range from 1 inch to 4 inch.

Most manufacturers rate their air scoop product lines for 125 psi with a maximum operating temperature of 300°F. Air scoops are installed in conjunction with an expansion tank and air vent as shown in figure 7.

(See Taco Catalog# 100-7.2 for additional information.)

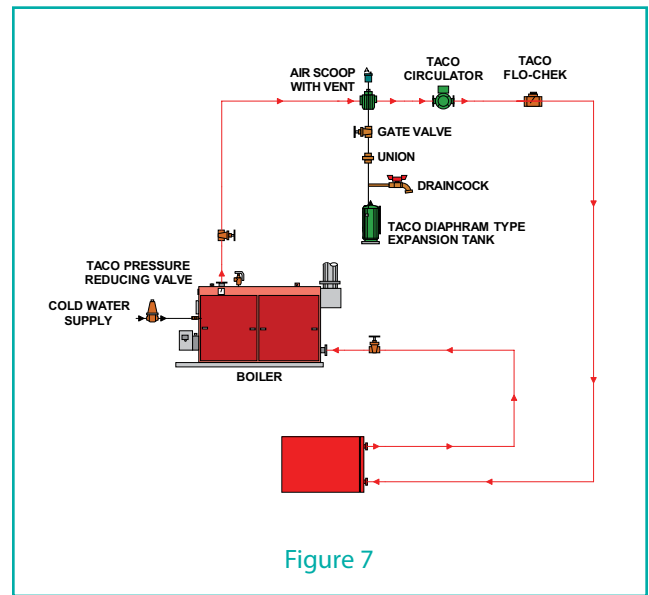

Figure 7

Applications

- Smaller systems
- Lower cost
- Compact installation

VorTech®

Taco VorTech® Air Separators are applied in residential and light commercial applications for the removal of free air in water or water/glycol systems. The body of a VorTech features a primary separation chamber where the process of air elimination is controlled and optimized.



The body of each VorTech is specially designed to direct the flow of the system fluid tangentially exiting at the bottom of the chamber. To assist with the removal of larger air pockets each VorTech incorporates a 300 series stainless bubble breaker cartridge to breakup larger air volumes.

Due to the tangential effect the system fluid with its higher density is pushed to the outside wall of the chamber as the less dense air is directed toward the vortex of the flow and vented from the system.

Optimum performance is achieved at line velocities up to 4 ft/sec. However, VorTech style units have been successfully installed on applications with velocities up to 8 ft/sec. VorTech separators are specifically designed for the line size which they are to be installed. These sizes range from 3/4 inch to 2 inch.

VorTech style separators are rated for 150 psi with a maximum operating temperature of 240°F. VorTech are commonly installed in conjunction with an expansion tank and air vent as shown in Figure 8.

4900 Series Air Separator

Taco 4900 Series Air Separators use a patented, independently proven method for removing gasses from water: the PALL ring process. Inside the 4900, PALL rings accumulate and then completely eliminate micro-bubbles from 15 microns and up. That's bubbles which are 3 times smaller than the nearest competitions scrubbing design. What's more, Taco's unique conical venting chamber with integral shut-off and protective plate keeps waterborne dirt and impurities well clear of the venting mechanisms so that fouling of the vent is eliminated during normal operation.



Applications

- Smaller systems
- Higher efficiencies
- Compact installation

(See Taco Catalog# 100-2.9 for additional information.)

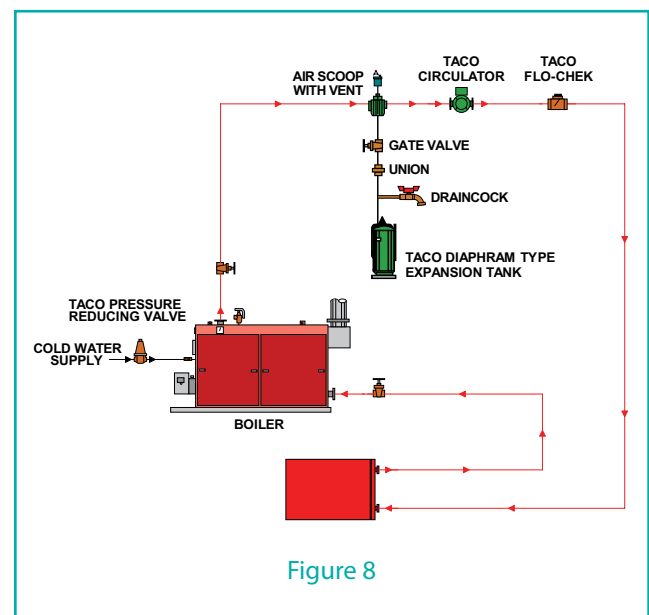

Figure 8

Applications

Tangential ASME Air Separators

Taco Tangential Air Separators are applied in commercial, institutional and industrial applications for the removal of free air in water or water/glycol systems. The Tangential design air separators utilize the difference in density to separate free air from system fluid.

System fluid within a tangential air separator is forced to the wall of the separator due to centrifugal force. The less dense air then migrates to the center of the separator for venting at the top of the unit. Tangential air separators produce higher pressure drops than in-line or micro-bubble separators due to the vortex development within the unit.



These units are designed, built, tested and stamped to the requirements of ASME. Manufacturers offer tangential separators in working pressures of 125, 150, 250, 300 psi and higher if required.

Optional stainless steel strainers are specified to capture and allow the removal of large debris. These screens are normally specified with 3/16 inch perforations and free area of not less than 5 times the open area of the nozzle to minimize pressure drop. Most manufacturers provide a blowdown connection at the bottom of the unit.

When Tangential Air Separators are installed in conventional Air Control systems with plain steel expansion tanks (Figure 9) care must be taken to insure that piping between the air vent and the plain steel tank is pitched at least 3 degrees to facilitate the migration of captured air back into the expansion vessel. Systems with plain steel expansion tanks must not have automatic air vents installed as this will lead to the loss of the expansion tank compression cushion. When Tangential Air Separators are installed in Air Elimination systems (Figure 10) with Captive Air bladder or diaphragm style expansion tanks, automatic

air vents should be installed at the top of each air separator. As Air Elimination systems have a permanent separation provided by the bladder or diaphragm between the initial tank pre-charge and the system fluid no loss of pre-charge will occur.

(See Taco Catalog# 400-3.1 for additional information.)

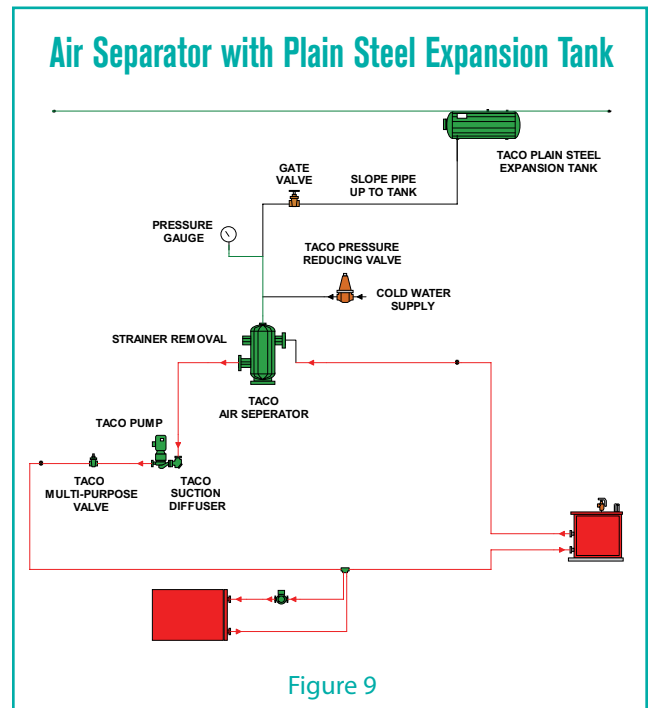

Figure 9

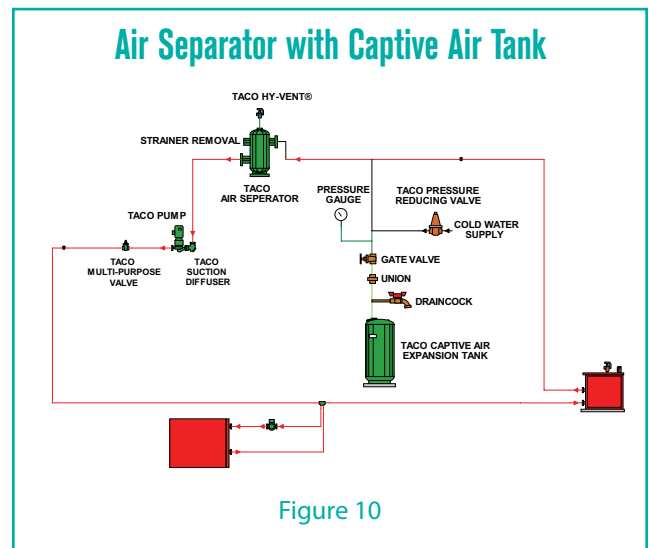

Figure 10

4900 Series High Efficiency Micro-Bubble Air and Dirt ASME Separator

Taco 4900 Series High Efficiency Micro-Bubble Air and Dirt Separators are applied in commercial, institutional and industrial applications for the removal of free and entrained air. The 4900 Series utilize the coalescence of micro air bubbles around PALL rings to separate free air from a system fluid.

The 4900 Series incorporates the highest available **coalescence** surface area available on the market today. This enhanced surface area allows the removal of micro-bubbles as small as 15 microns in diameter. **The 4900 Series separators remove up to 99.6% of the dissolved air through the action of coalescence.** This feature is especially beneficial in correcting problems in air entrained systems.



Units are designed for low Pressure drops typically under 2 PSIG.

An additional feature of the 4900 Series is the capability to remove dirt sizes as small as 5 microns from hydronic systems. **The 4900 Series separators remove up to 100% of the free air, 100% of the entrained air, and up to 99.6% of the dissolved air in the system fluid.** This feature is especially beneficial in correcting problems in air entrained systems.

The 4900 Series has been designed in **two velocity ranges**, a standard product series suitable for line velocity to 4.9 ft/sec. and a high velocity series suitable for line velocities up 11 ft/sec. The performance of the 4900 product line has been independently tested and published. (These test results are available through your local Taco representative.)

These units are designed, built, tested and stamped to the requirements ASME Section VIII, Division 1. Manufacturers offer micro bubble air and dirt separators in working pressures of 125, 150, 250 psi.

When High Efficiency Micro Bubble Air and Dirt Separators are installed in conventional Air Control systems with plain steel expansion tanks (Figure 9) care must be taken to insure that piping between the air vent and the plain steel tank is pitched at least 3 degrees to facilitate the migration of captured air back in the expansion vessel. Systems with plain steel expansion tanks must not have automatic vents installed as this will lead to the loss of the expansion tank compression cushion.

When High Efficiency Micro Bubble Air and Dirt Separators are installed in Air Elimination systems (Figure 10) with Captive Air bladder or diaphragm style expansion tanks, automatic air vents should be installed at the top of each air separator. As Air Elimination systems have permanent separation provided by the bladder or diaphragm between the initial tank pre-charge and the system fluid no loss of pre-charge air will occur.

(See Taco Catalog# 400-1.4 for additional information.)

Applications

- Larger systems
- Higher efficiencies
- Higher velocities
- Removal of smaller air bubbles, e.g. removal of air in air entrained systems (removes micro air bubbles)
- Removal of smaller particles, e.g. cleaning of dirty systems (removes particles and dirt)

Selection Procedure

Example 1 [Less Strainer]

Problem:

Select an air separator for a new installation. The system will have better than average maintenance and the primary pumps in the system have suction diffusers with strainer.

Conditions:

Flow rate = 700 gpm
Pipe size = 8"
Velocity = 4.5 fps
Maximum pressure drop = 2 ft.

1. Determine the type of air separator required. For removal of air in a system of this larger flow rate this would require a Taco Air Separator with a model number beginning with "AC".

For system with better than average maintenance and strainers in the pump suction diffusers select the standard unit without a strainer. No additional letter designation is required.

2. Determine the velocity range of the AC Series that is suitable for these conditions. The recommended velocity range for the standard unit is 10 fps. This would require a unit with a line size of 6" (7.77 fps)
3. Determine the size of the AC for the specified maximum pressure drop. For a maximum pressure drop of 2 ft. the unit size required is a 6" (1.8 ft.). **This is Model AC06.**



ACG06-125R

Example 2 [With Strainer]

Problem:

Select an air separator for an existing installation. The system has less than average maintenance and there are no strainers in the suction diffusers in the primary pumps.

Conditions:

Flow rate = 230 gpm
Pipe size = 4"
Velocity = 5.8 fps
Maximum pressure drop = 2 ft.

1. Determine the type of air separator required. For removal of air in a system of this larger flow rate would require a Taco AC Series Air Separator with a model number beginning with "AC".

For a system with less than average maintenance and no strainers in the primary pumps select the unit with removable strainer for easier cleaning. This is a model number ending with an "F".

2. Determine the velocity range of the AC Series that is suitable for these conditions. The recommended velocity range for the AC unit is 10 fps. This would require a unit with a line size of 3" (9.98 fps).
3. Determine the size of the AC for the specified maximum pressure drop. For a maximum pressure drop of 2 ft. the unit size required is a 4" (1.6 ft.). **This is Model AC04F.**



AC04F-125

Specifications

Furnish and install as shown on plans an external air separator consisting of a steel tank _____" diameter X _____" long.

The unit shall have _____" (NPT/flanged) inlet and outlet connections and strainer removal connection where specified. The removable strainer shall be of 304 stainless steel with 3/16" diameter perforations and a free area of not less than five times the cross-sectional area of the connecting pipe. When strainer is specified, installer shall remove and clean strainer after 24 hours operation and after 30 days operation. There shall be a bottom connection for blowdown cleaning. Unit must be designed, constructed and tested in accordance with the ASME Boiler and Pressure Vessel Code and stamped 125, 150, 250 and 300 psig design pressure. Each air separation unit shall be Taco, Inc. Model No. _____ or equal. ASME B16.5 flanges shall be provided on all units 3" or larger. ASME Code data reports are to be supplied by the air separator manufacturer upon request.

Pressure Drops
Air Separator Pressure Drop WITH Strainer

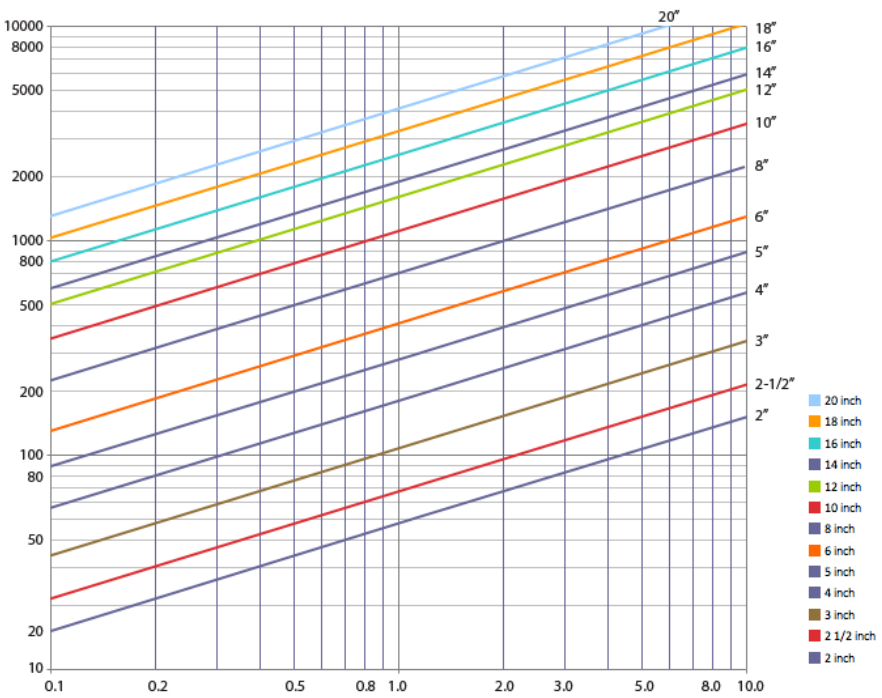

Air Separator Pressure Drop WITHOUT Strainer

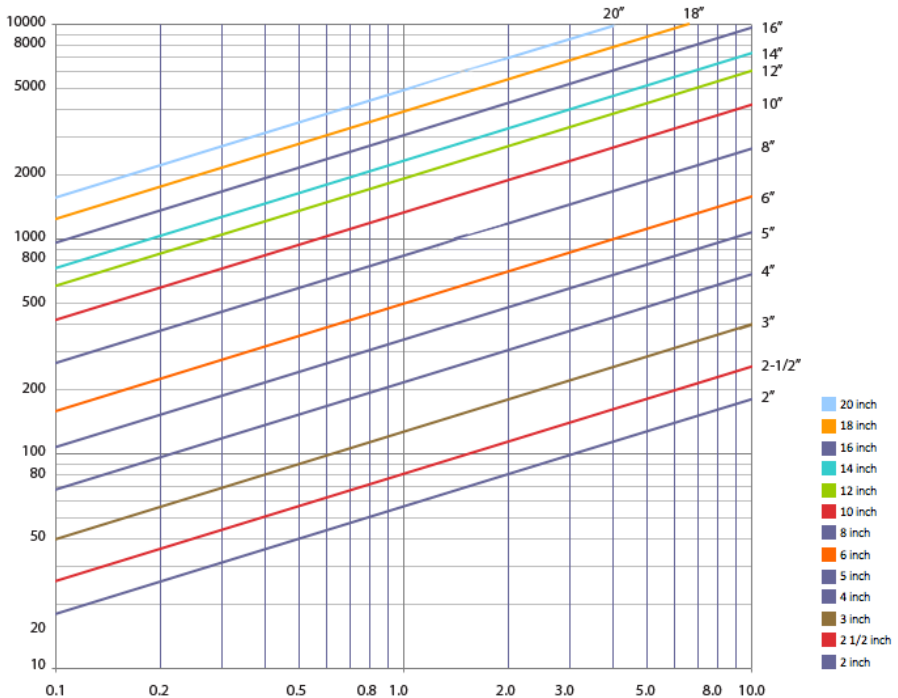

Submittal Data Information

In-Line Air Separators

Submittal Data #401-107
[Refer to all other submittals listed at bottom]

Effective: 03/01/13

Supersedes: New

Pipe Size Inch	Model Number		A Dia. Inch	B Max. Inch	C Inch	D Inch	E Inch	F Inch	G Dia. Inch	H Inch	Max. Flow GPM	Strainer Free Area Inch ²	C _v Factor	Approx. Wt. (LBS.)	C _v Factor	Approx. Wt. (LBS.)
	Less Strainer	With Strainer														
2	AC02	AC02F	12	22-1/8	13	7-9/16	7	14	-	-	80	31	86	40	72	45
2-1/2	AC025	AC025F	12	22-1/8	13	7-9/16	7	14	-	-	130	38	122	40	102	45
3	AC03	AC03F	14	27-1/4	22	8	11-1/4	24	12	6-1/2	190	51	190	90	162	110
4	AC04	AC04F	16	31-3/8	24	9-5/16	12-3/4	26	12	7	330	80	325	115	272	145
5	AC05	AC05F	16	32-1/2	24	9-3/8	13-3/4	26	12	7	550	112	510	130	422	165
6	AC06	AC06F	20	36-7/8	27	11-1/16	14-3/4	30	16	6-3/4	900	180	750	170	618	215
8	AC08	AC08F	20	45-1/2	27	14-1/16	17-3/8	30	16	6-3/4	1500	246	1260	270	1060	345
10	AC10	AC10F	24	47-3/4	32	14-15/16	17-7/8	36	20	6-3/4	2600	392	2000	350	1670	465
12	AC12	AC12F	30	59-3/4	37	17-5/8	24-1/2	42	24	7-3/4	3400	548	2900	600	2400	775
14	AC14	AC14F	36	68-1/2	44	20-3/4	27	48	30	7-3/4	4700	732	3500	805	2850	1035
16	AC16	AC16F	36	75-1/2	43	22-1/4	31	48	30	7-3/4	6000	845	4600	875	3800	1150
18	AC18	AC18F	48	84-1/4	56	24-5/8	35	64	40	7-3/4	8000	1290	5900	1550	4900	1900
20	AC20	AC20F	48	91	56	26	39	64	40	8 5/8	10000	1435	7400	1700	6200	2150

Larger units up to 36" (914 mm) are available. Please Contact the Factory.

SPECIFICATIONS

- Designed and constructed per ASME Code Section VIII, Division 1.
- Standard Design Pressure and Temperature
- Construction: Carbon Steel with exterior red oxide primer finish w/ optional 304SS Strainer
- Registered with the National Board of Pressure Vessel Manufacturers
- U-1A Data Report

OPTIONS (Consult Factory)

- Higher design pressures and temperatures
- Optional System Connection sizes available
- Larger sizes available up to 36" diameter
- Grooved Connections

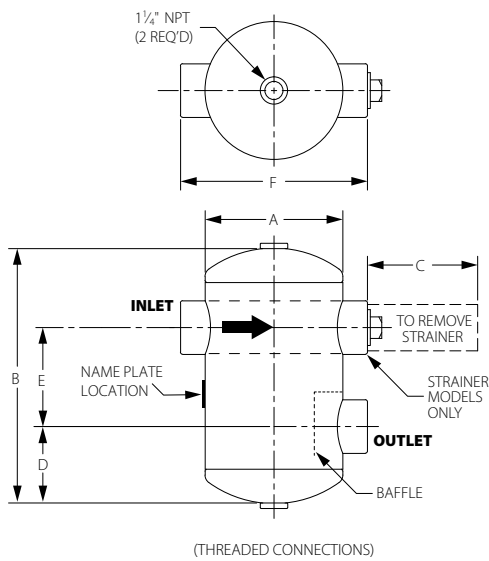

(THREADED CONNECTIONS)

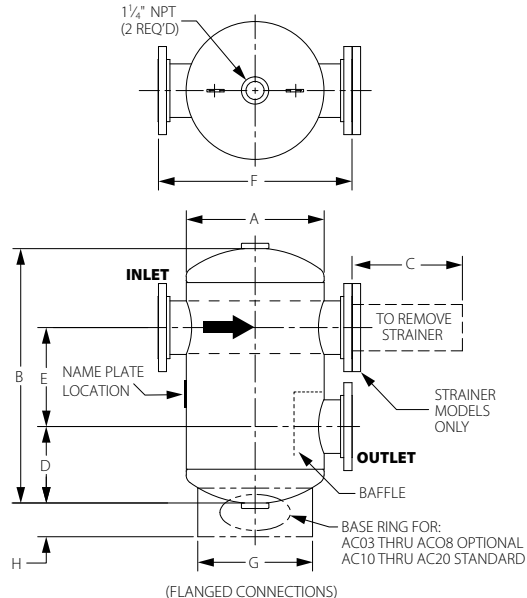

(FLANGED CONNECTIONS)



Submittal Sheets Available at www.taco-hvac.com
Grooved Connections

125 PSI @ 375°F Document 401-108
150 PSI @ 375°F Document 401-111



Submittal Sheets Available at www.taco-hvac.com
Flanged Connections

125 PSI @ 375°F Document 401-107
150 PSI @ 375°F Document 401-110
250 PSI @ 375°F Document 401-095
300 PSI @ 375°F Document 401-096