

TRUE  FLAME



OUTDOOR KITCHEN CATALOG

FEATURED:
TF32-NG/LP



TrueFlame Grill

The TrueFlame grill redefines value with premium craftsmanship. Available in 40", 32", & 25" models, each is packed with all the features you could hope for in a grill. Interior and exterior lighting, square stainless steel cooking grates, heat separators for optimal control make gourmet grilling easy. With the Gold Standard Warranty, this is a commercial grade quality grill you can trust. Beauty & durability come together to create this truly high performance grill.





TrueFlame Grill Series



TrueFlame Grill - 25", 32", 40"

TF25-NG/LP, TF32-NG/LP, TF40-NG/LP

- Exterior Lighting Behind Each Knob Indicating On/Off Burner State
- Full Length Exterior LED Bar Above Knobs
- Halogen Interior Lighting
- Heat Zone Separators
- #304 Stainless Steel Flame Tamers / Burner Covers
- Square Stainless Steel Cooking Grates
- Constructed with #304 Stainless Steel
- #304 Cast Stainless Steel Burners
- 14,000 BTU Burners
- Flame Thrower Ignition
- 10,000 BTU Infrared Back Burner (32" & 40" Only)
- Balanced, Multi-Position Hood Hinge
- Warming Rack with Inset, Removable Cooking Tray
- ETL Certified
- Rotisserie Kit Available
- Deluxe Vinyl Grill Cover Available
- Optional drop in sear burner (TF-IRB)



#304 Stainless Steel Construction

TrueFlame grills are constructed of the highest quality #304 stainless steel, adding a luxurious sheen and elegant touch to your backyard. This premium material is highly resistant to rust, discoloration, and wear, ensuring that your grill looks great and performs reliably for years to come.



Interior & Exterior Lighting

Two interior halogen lights help illuminate the expansive grilling surface, while a full-length LED strip gives maximum front panel visibility. The knobs feature a backlit ON/OFF indication light, so you can easily and safely see which burners are ignited.



Square Cooking Grates

Heavy-duty square cooking grates increase the contact surface with your food, offering beautiful grill lines and bolstering the flavor profile. These cooking grids are stainless steel, making them long-lasting and easy to clean.



Multi-Position Hood Hinge

The balanced, multi-position hood hinge allows you to open your hood to any degree, gaining access to your food without losing too heat—plus, the knurled finish of the stainless steel hood handle provides extra grip when lifting the hood.



14,000 BTU Cast Stainless Burners

A trusted Flame-Thrower Ignition mechanism ignites 14,000 BTU cast stainless burners, supplying incredible heat for searing and grilling. These burners are cast from #304 stainless steel, ensuring a longevity, durability, and performance.



IR Back Burner & Rotisserie Kit

The 32" and 40" models feature a 10,000 BTU Infrared Back Burner with an optional Rotisserie Kit, allowing you to enjoy perfectly cooked, juicy meats as they slowly turn on the spit, infusing them with delicious flavor and an irresistible aroma.



Warming Rack with Cooking Tray

A full-length, stainless steel warming rack not only adds to the useable cooking surface of your grill, but also features an inset, removable stainless steel tray for cooking vegetables, searing, roasting, and more.



#304 Stainless Steel Flame Tamers

The #304 stainless flame tamers / burner covers are designed to provide superior protection and durability to your grill's burners, while also distributing heat and vaporizing drippings. They are easy to remove and install, making it effortless to maintain the quality and cleanliness of your grill.



Freestanding Carts

TrueFlame's premium grill carts offer an alternative solution to outdoor dining. Durable and sleek, these stainless steel carts feature soft close drawers, propane tank storage, and collapsible shelving.



TrueFlame Deluxe Grill Cart

CART-TF-25DC / CART-TF-32DC / CART-TF-40DC

- Commercial Grade Stainless Steel
- Magnetic access doors
- Front Locking Caster Wheels
- Interior Paper Towel Holder
- 2 Foldable Side Shelves
- Propane Tank Storage
- Side, Rear, and Bottom Ventilation
- Fully Assembled

TrueFlame Built-In Gas Griddle

Explore new flavors with the premium 30" Gas Griddle Grill. This #304 stainless steel, heavy-duty flat top grill is the perfect addition to your outdoor kitchen, diversifying your menu, and adding a host of new flavors. The expansive, 495-square-inch cooking surface is made of half-inch thick steel, powered by two 18,000 BTU U-Tube burners below. The combined 36,000 BTUs of power guaranty searing heat, perfect for steaks, burgers, carne asada, eggs, pancakes, and more. The full-size, #304 stainless steel cover ensures your griddle plate is protected from the elements and always ready for the next meal. Fire up the Gas Griddle and take your culinary experiences to new heights.



TrueFlame 30" Gas Griddle

TFG30-NG/LP



FEATURES

- #304 Stainless Steel Construction
- 1/2" Thick Stainless Steel Cooking Surface
- 495 Sq. Inches of Cooking Surface
- 18,000 BTU #304 Stainless Steel U-Tube Burners
- 36,000 Total BTU Output
- Included #304 Stainless Steel, Removable Lid
- Red Exterior LED Lighting
- High-Power, Reliable Flame-Thrower Ignition
- Large Capacity Drip Tray
- Grill Liner Available - GL-TFGRID30
- Overall Dimensions: 30" W x 28" D x 12" H
- Weight: 120 LB.
- ETL Certified
- Gold Standard Warranty



Side & Power Burner

The TrueFlame Side & Power Burners combine the benefits of an indoor range with the joy of cooking outdoors. The perfect addition to your outdoor kitchen, these appliances offer convenience and performance to your outdoor oasis. With the matching design and exterior LED lights of the TrueFlame grill line, these burners bring high BTU output to boil, cook, or saute while you grill. Upgrade your outdoor kitchen today, so you're ready for the backyard gathering of a lifetime.



TrueFlame Double Side Burner

TFSB2-NG/LP

- Total BTU's 24,000
- Stainless Steel Construction
- Removable, Stainless Steel Lid
- Brass Plated Burners
- ETL Certified
- Deluxe Vinyl Cover Available



TrueFlame Power Burner

TFPB-NG/LP

- Total BTU's: 60,000
- Stainless Steel Construction
- Removable, Stainless Steel Lid
- Dual, Cast Stainless Ring Burners
- Removable Wok Grate
- ETL Certified
- Deluxe Vinyl Cover Available

Refrigeration

Enjoy fresh ingredients and chilled beverages with TrueFlame's extensive line of outdoor refrigeration. With up to 6.6 cubic feet of storage, these appliances will facilitate food preparation and storage needs for your outdoor kitchen. All TrueFlame refrigeration offer durable construction for the outdoors, temperature control, adjustable legs for leveling, and sleek design for function and beauty. Bring the function of your indoor refrigeration outside with matching performance and design.



FEATURED:
TF-RFR-24S-R (Left)
TF-RFR-24S (Right)

Wine Coolers

FEATURES

- #304 Stainless Steel Door Construction
- UL Rated for Outdoor Use
- Locking Doors
- Front Venting
- Left & Right Doors Available
- Auto-Defrost
- Electronic Temperature Controller w/ Digital Display
- Commercial & Residential Compliant

15" 3.2C Outdoor Rated Dual Zone Wine Cooler

TF-RFR-15WD

- Storage Capacity: 3.2 ft³
- 20 Bottle Capacity
- Upper Temperature Range: 41° - 50°
- Lower Temperature Range: 50° - 64°

24" 5.3C Deluxe Outdoor Rated Dual Zone Wine Cooler

TF-RFR-24WD

- Storage Capacity: 5.3 ft³
- 46 Bottle Capacity
- Upper Temperature Range: 41° - 50°
- Lower Temperature Range: 50° - 64°



24" 5.3C Deluxe Outdoor Rated Wine Cooler

TF-RFR-24W

- Storage Capacity: 5.3 ft³
- 46 Bottle Capacity
- Temperature Range: 41° - 64°



15" 3.2C Outdoor Rated Single Zone Wine Cooler

TF-RFR-15W

- Storage Capacity: 3.2C ft³
- 20 Bottle Capacity
- Temperature Range: 41° - 64°

Outdoor Refrigeration

FEATURES

- #304 Stainless Steel Door Construction
- UL Rated for Outdoor Use
- Locking Doors
- Front Venting
- Left & Right Doors Available
- Auto-Defrost
- Electronic Temperature Controller w/ Digital Display
- Commercial & Residential Compliant



24" 6.6C Deluxe Outdoor Rated Kegerator (No Tap / Single Tap / Double Tap)

TF-RFR-24DK / TF-RFR-24DK1 / TF-RFR-24DK2

- Storage Capacity: 6.6 ft³
- Top Guard Rail Sold Separately
- Available in Single or Double Tap Towers
- 32° - 50° Temperature Range

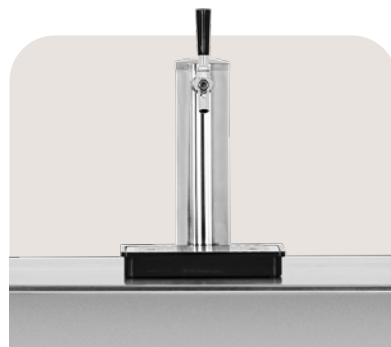

Single Keg Tap for Kegerator

TF-RFR-TAP-1

- Fits TF-RFR-24DK
- Includes Tap Tray, Single Hose, CO2 Kit (Tank & Regulator)



Double Keg Tap for Kegerator

TF-RFR-TAP-2

- Fits TF-RFR-24DK
- Includes Tap Tray, Two Hoses, CO2 Kit (Tank & Regulator)

24" 5.3c Outdoor
Rated Refrigerator

TF-RFR-24S / TF-RFR-24S-R

- Storage Capacity: 5.3 ft³
- 32° - 50° Temperature Range

24" 5.3c Deluxe
Outdoor Rated
Refrigerator

TF-RFR-24D / TF-RFR-24D-R

- Storage Capacity: 5.3 ft³
- 32° - 50° Temperature Range



15" 3.2C Outdoor
Rated Refrigerator

TF-RFR-15S

- Storage Capacity: 3.2 ft³
- 32° - 50° Temperature Range

15" 3.2C Outdoor
Rated Refrigerator
with Glass Door

TF-RFR-15G

- Storage Capacity: 3.2 ft³
- 32° - 50° Temperature Range
- Tinted Glass



21" Refrigeration

FEATURES

- #304 Stainless Steel Door Construction
- Storage Capacity 4.2 ft³
- Locking Doors
- Manual Temperature Controller
- Rear Venting
- Commercial & Residential Compliant

21" 4.2C Compact Refrigerator

TF-RFR-21S / TF-RFR-21S-R

- Reversible Door Capability
- 32° - 50° Temperature Range

21" 4.2C Deluxe Compact Refrigerator

TF-RFR-21D / TF-RFR-21D-R

- Left and Right Doors Available
- 32° - 50° Temperature Range



50 lb. 15" Deluxe Outdoor Rated Ice Maker w/ Gravity Drain

TF-IM-15

Ice Maker

FEATURES

- Daily Ice Output: 50 lbs.
- Storage Capacity: 25 lbs.
- Gravity Drain
- Temperature Control Not Necessary



2-Drawer Refrigerator

FEATURES

- Storage Capacity 5.3 ft³
- Two Soft-Close Drawers
- Temperature Range 32° - 50°
- UL Rated for Outdoor Use
- Front Venting
- Auto Defrost
- Electronic Controller w/ Digital Display
- Commercial & Residential Compliant

24" 5.3C Deluxe Outdoor Rated
2-Drawer Refrigerator

TF-RFR-24DR2



FEATURED: 24" 2-DRAWER REFRIGERATOR

Sinks and Bar Prep

Transform your outdoor living space into a culinary haven with our premium selection of outdoor kitchen sinks and bar preparation stations. Our sinks are the perfect addition to any outdoor kitchen, featuring durable stainless steel construction with options for under-mount, top-mount, or built-in installation. The stainless steel Lighted Beverage & Prep Station also makes for an entertainer's dream, featuring covered ice storage, sink, bottle opener, condiment bins, and more!



15" Drop-in Sink & Hot/Cold Faucet

TF-NK-15D



19" Undermount Sink & 360° Hot/Cold Faucet

TF-NK-19U



Farmhouse Sink

TF-NK-32FH

* FAUCET SOLD SEPARATELY



30" Lighted Beverage & Prep Station

TF-BC-30L



14" Trash Chute & Cutting Board with Lid

TF-TC-14



FEATURED:
19" UNDERMOUNT SINK & FAUCET

Ice Chests

With our grills heating things up, we have just what you need to keep cool. Choose between two sizes to optimize your serving station. With up to 40 lbs. of ice capacity, load them up with refreshments, snacks, or ingredients to make for a good time.



17" 1.7c Drop-in Cooler
(20lb Ice Capacity)

TF-IC-17



28" 2.7c Drop-in Cooler
(40lb Ice Capacity)

TF-IC-28

Accessories

Make your kitchen the way you want it... TrueFlame offers a variety of miscellaneous conveniences, upgrades, and appliances to customize your outdoor space to your liking. All products feature high-grade stainless steel construction for durability and performance.

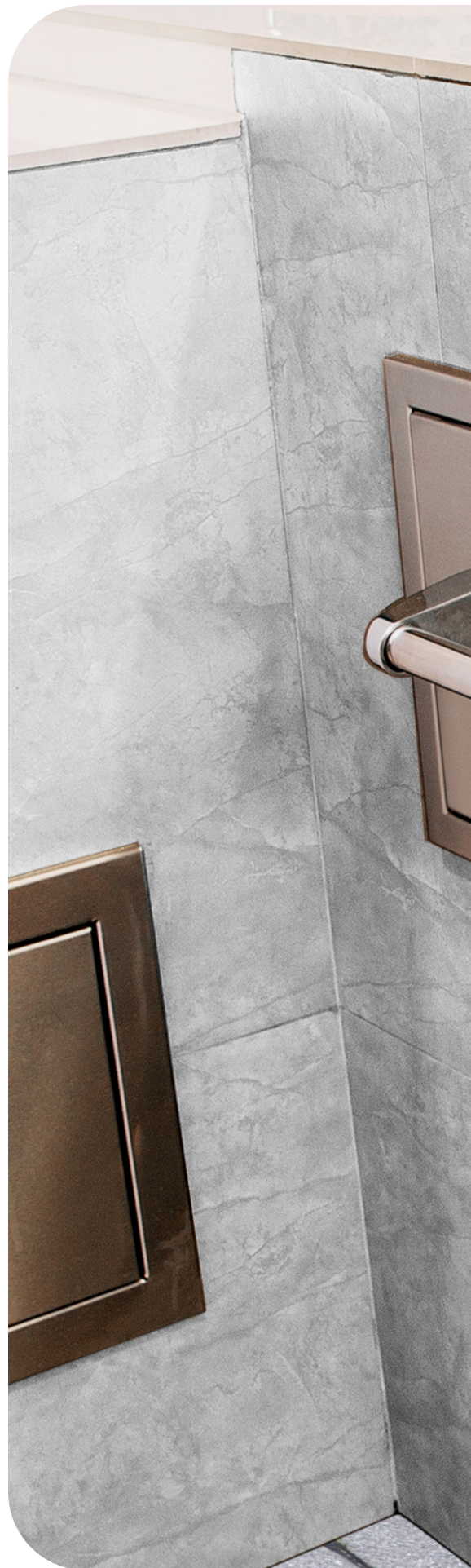

FEATURED:
36" WARMING DRAWER



Access Doors

Our access doors give you elegant and convenient access to your island, utilities, and grill. Made with commercial grade stainless steel, heavy-duty flanges, reversible door mounting, and magnetic latches.



33" Vented Double Access Door

TF-DD-33V

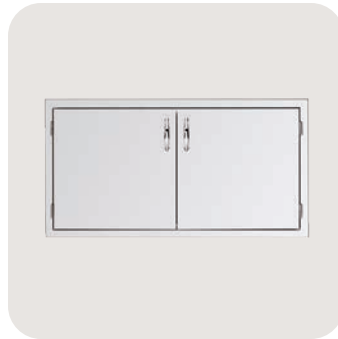

Double Access Door (26", 30", 33", 36", 39", 42", 45")

TF-DD-26 / TF-DD-30 / TF-DD-33 / TF-DD-36 / TF-DD-39 / TF-DD-42 / TF-DD-45



Vertical Access Door (16", 18", 20")

TF-DV-16 / TF-DV-18 / TF-DV-20

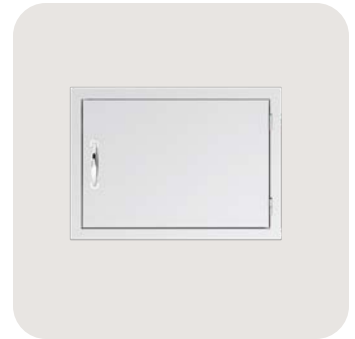

Horizontal Access Door (22", 27")

TF-DH-22 / TF-DH-27

Door/Drawer Combos

These components are specifically designed with versatility in mind. Whether you need a simple storage setup, LP tank drawer, paper towel holder, or weather-resistant dry storage shelving, these commercial grade stainless steel combos give you the options you need for a perfect outdoor setup.



2-Drawer & Access Door Combo (30", 33", 36", 42")

TF-DC2-30 / TF-DC2-33 / TF-DC2-36 / TF-DC2-42



33" 3-Drawer & Access Door Combo

TF-DC3-33



33" 2-Drawer & LP Tank Pullout Drawer Combo

TF-DC2-33LP



FEATURED: 33" 3-DRAWER & ACCESS DOOR COMBO

Storage Drawers

Our line of drawers are feature-packed storage options that ensure you get exactly what you need in your backyard set up. Made with commercial grade stainless steel, these drawers feature heavy-duty flanges and soft closing drawers.



17" Single Drawer

TF-DR1-17



17" Double Drawer

TF-DR2-17



17" Triple Drawer

TF-DR3-17



17" Vertical 2-Drawer & Paper Towel Holder Combo

TF-TDC-17



20" Trash Pullout Drawer

TF-TD1-20



20" Trash & Recycling 2-Bin Pullout Drawer

TF-TD2-20



17" Paper Towel Holder

TF-TH-17



20" Vented Liquid Propane Tank Or Trash Drawer

TF-DR1-20LP



26" Utensil Drawer

TF-DR1-26U

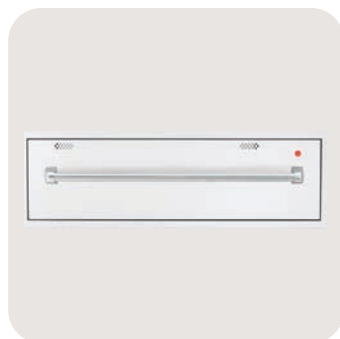

36" Warming Drawer

TF-WD-36

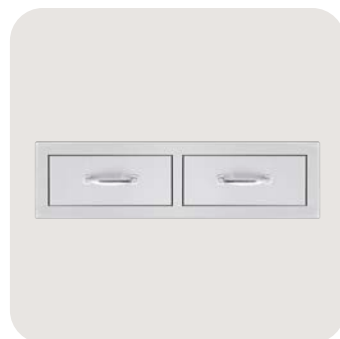

32" Double Horizontal Drawer

TF-DR2-32H



FEATURED: 20" TRASH PULLOUT DRAWER



FEATURED: 33" MASONRY DOUBLE ACCESS DOOR

Masonry Storage

Our line of Masonry Storage is perfect for islands with stone or brick finishes. The increased flange depth makes for a seamless fit and streamlined installation. These commercial grade stainless steel components can also be used to add an attractive contrast to any island with stucco or Ameristone finishes.



20" Masonry Vented
Liquid Propane Tank or
Trash Drawer

TF-TD1-20M



33" Masonry 2-Drawer
& Access Door Combo

TF-DC2-33M



Masonry Double Access
Door (33", 45")

TF-DD-33M / TF-DD-45M



17" Masonry Double Drawer

TF-DR2-17M



17" Masonry Vertical
2-Drawer & Paper Towel
Holder Combo

TF-TDC-17M



20" Masonry Vertical
Access Door

TF-DV-20M



27" Masonry Horizontal
Access Door

TF-DH-27M

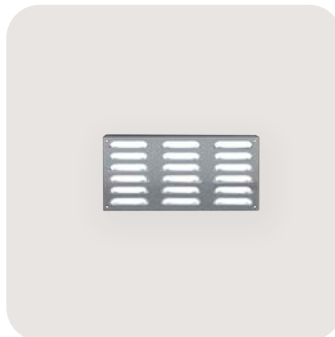

12" Masonry Island
Vent Panel

TF-IV-12M

Dry Storage

This line of dry storage pantries is a solution that offers heavy-duty weather-resistant seals to give you peace of mind year-round—that means moisture and critters are locked out for good. Made with high quality commercial grade stainless steel, these pantries feature heavy-duty flanges and magnetic latches.



36" 2-Drawer Dry Storage Pantry & Enclosed Cabinet Combo

TF-DP-36DC



36" 2-Drawer Dry Storage Pantry & Access Door Combo

TF-DP-36AC



FEATURED:
36" 2-DRAWER DRY STORAGE PANTRY & ACCESS COMBO
20" TRASH PULLOUT DRAWER

Vent Hoods

Protect your outdoor kitchen with our commercial-grade Vent Hoods. Many BBQ Islands and outdoor kitchens are made under a pergola or porch. A vent hood provides the protection you need to ensure a safe and reliable entertaining space for years to come. Each Vent Hood features durable double-lined #304 stainless steel construction for maximum strength and protection, stainless steel top/side mounting ducting, and a matching sleek design. The Vent Hood not only protects your outdoor kitchen but also protects the chassis of your built-in grill from corrosion, adding to the longevity of your grill. Use TrueFlame Vent Hoods to make your outdoor kitchen a safe and entertaining space for your family and friends to enjoy.

FEATURES

- 36" / 48" / 60"
- 1200 CFM'S
- Dual Venting / Top or Rear
- #304 Stainless Steel Construction
- 1/2" Mounting Bracket Included
- Spacer Kits Available



Vent Hoods (36", 48", 60")

TF-VH-36 / TF-VH-48 / TF-VH-60



12" Duct Cover (36", 48", 60")

TF-VH-36-DC / TF-VH-48-DC /
TF-VH-60-DC



1/2" Mounting Bracket
(36", 48", 60")

TF-VH-36-SPT /
TF-VH-48-SPT / TF-VH-60-SPT



Spacer Brackets (4", 8")

TF-VH-36-SP4 / TF-VH-48-SP4 /
TF-VH-60-SP4 / TF-VH-36-SP8 /
TF-VH-48-SP8 / TF-VH-60-SP8



Gas Timer & Mounting Plate



Gas Timer with
Emergency Shutoff /
Mounting Plate
*Mounting Plate Sold Separately

TF-ESTOP1-0H



Expandable Masonry Gas
Timer Kit

TF-ESTOP-CP-KIT



Gas Timer Locking
Cabinet

TF-ESTOP-LC-KIT /
TF-ESTOP-RM-KIT

Wind Guards



36" Stainless Steel Wind
Guard (Fits 30-32" Grills)

TFWG-36



48" Stainless Steel Wind
Guard (Fits 36-44" Grills)

TFWG-48

Grill & Island Accessories

TrueFlame offers a variety of island accessories that help bring your outdoor kitchen to the next level. Deluxe covers, rotisserie kits, griddles, and more, our outdoor accessories complete your kitchen and ensure the highest quality culinary experience.





Grill Cover

TFGC-25 / TFGC-32 / TFGC-40



Cart Cover

CARTCOV-TF25 / CARTCOV-TF32 / CARTCOV-TF40



Side & Power Burner Cover

GRILLCOV-TFSB2 / GRILLCOV-TFPB



30" Gas Griddle Cover

TFGC-GRID30



Griddle Plate

TF-GP-18



32" & 40" Rotisserie Kit

TFRK-32 / TFRK-40



Grill Liner

GL-TF25 / GL-TF32 / GL-TF40 / GL-TFGRID30



Side Burner Liner

GL-TFSB2 / GL-TFPB2



Refrigerator Trim
15"/21"/24" Series

TF-RTK-15 / TF-RTK-21 / TF-RTK-24 / TF-RTK-24W



14" Island Vent Panel

TF-IV-14

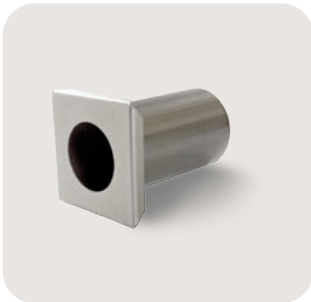

1.75" / 2" Umbrella Countertop Mounting Stanchion

TF-US-1 / TF-US-1L



Rotisserie Bag

TF-GRILLCOV-ROT32 / TF-GRILLCOV-ROT44

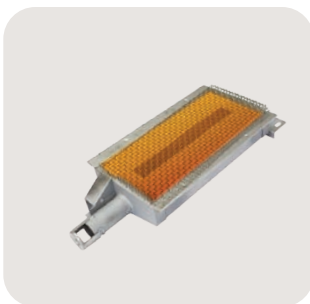

TrueFlame Drop-In Infrared Sear Burner

TF-IRB

*REFRIGERATION DOOR LINERS AVAILABLE

Product Dimensions

TF25

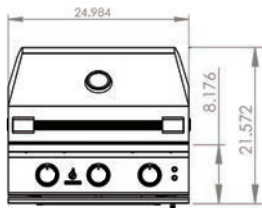

Front View

TF32

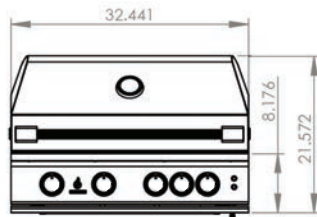

Front View

TF40

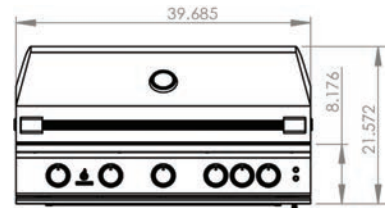

Front View

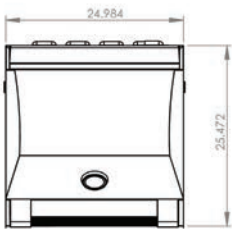

Top View

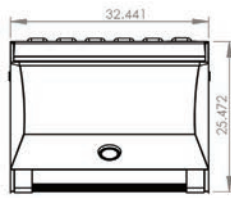

Top View

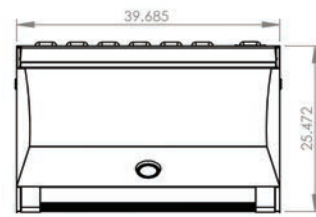

Top View

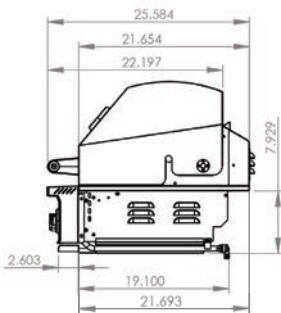

Side View

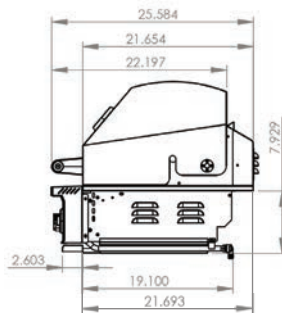

Side View

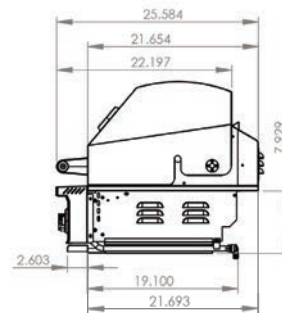

Side View

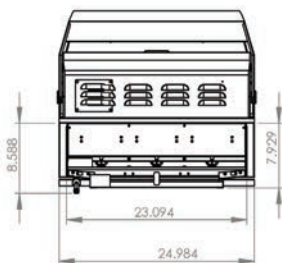

Back View

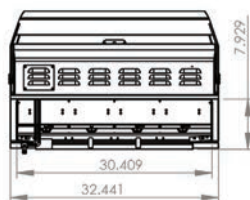

Back View

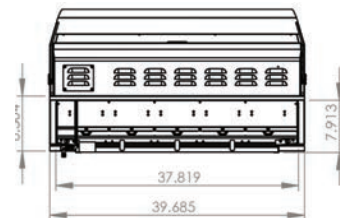

Back View

To view our recommended cutout dimensions,
scan the QR Code or visit the link:
www.trueflame.com/outdoor-kitchens/cutouts



Side Burner: TFS

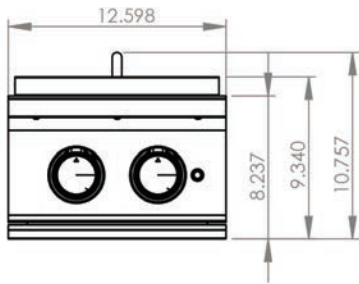

Front View



Top View

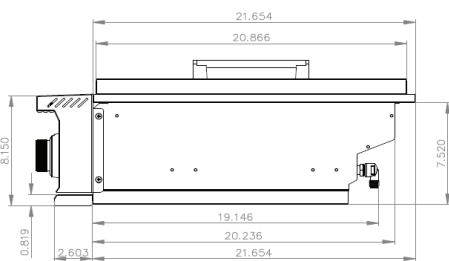

Side View

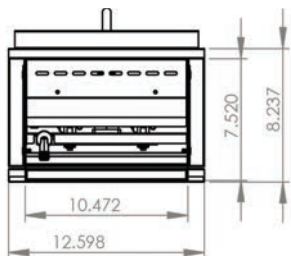

Back View

Power Burner: TFPB

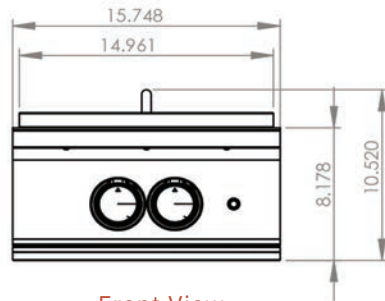

Front View

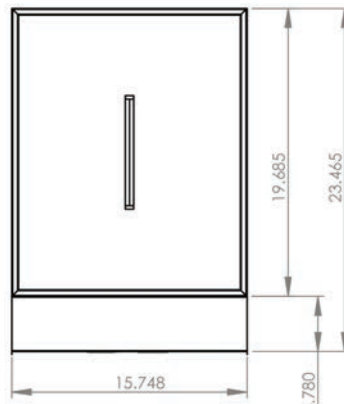

Top View

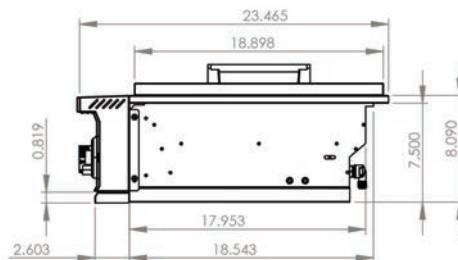

Side View

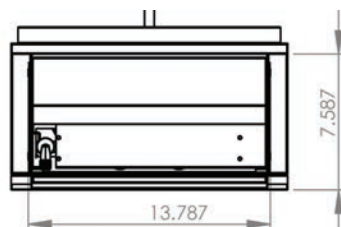

Back View

TFG30

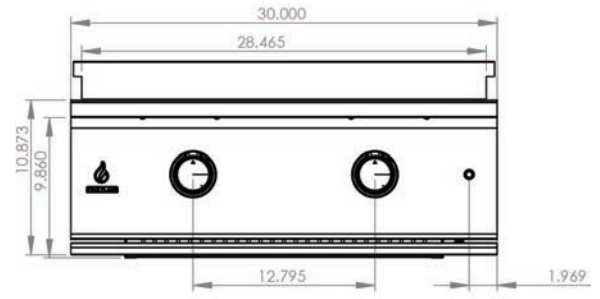

Front View

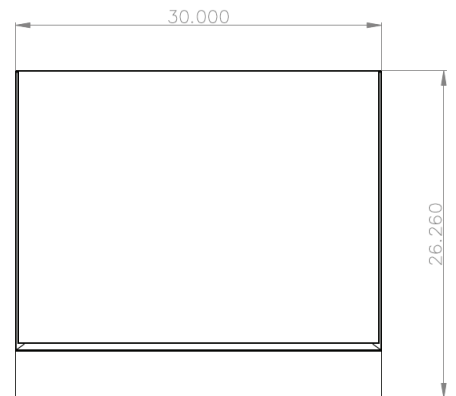

Top View

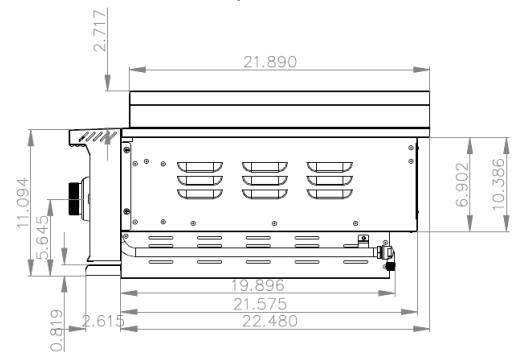

Side View

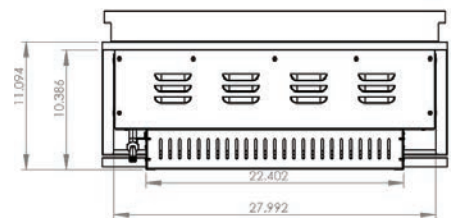

Back View



GOLD STANDARD WARRANTY

Your investment in TrueFlame products is backed by the strongest warranty in the industry. In addition to precision engineering and outstanding performance, TrueFlame products include our GOLD STANDARD LIFETIME WARRANTY with all replacement parts 100% non-prorated. Effective with purchases as of 3/1/23.

TrueFlame Warranty is valid for original purchaser at original site of delivery with proof of purchase and photo documentation only. Registration form must be submitted online within 30 days of the purchase date to validate the warranty. Warranty is void upon transfer of ownership. Warranty does not apply to products installed in any commercial, rental, or nonresidential application that have not maintained proper upkeep. Warranty covers replacement parts only. Manufacturer is not responsible for labor or labor-related costs. Warranty does not cover discoloration, surface rust, corrosion, or oxidation, which may occur due to harsh environments, chemicals, or overheating. Warranty will not apply for damage resulting from improper installations, abuse, extreme environments, grease fires, or misuse. Proof of regular and proper maintenance is required. Coastal, humid, and/or salt environments are subject to manufacturer review. All out-of-box claims must be made within 30 days of purchase and must be made prior to installation. Any product installed damaged will be considered damaged during installation and not covered under warranty. Warranty and registration forms are available at www.amddirect.com/register. Please be advised - all display models are sold "as is" and the warranty covers the following items only: main burners (Gold Standard Lifetime Warranty), grates (Gold Standard Lifetime Warranty), burner covers (Gold Standard Lifetime Warranty). All warranties are subject to the review and approval of the manufacturer.

14520 DELTA LANE SUITE 105,
HUNTINGTON BEACH, CA 92647

800.966.8126

AMDDIRECT.COM



GAS APPLIANCES (GRILLS, SIDE/POWER BURNERS, GAS GRIDDLE)

- Gold Standard Lifetime Warranty on Construction and Manufacturer Defects
- Gold Standard Lifetime Warranty on Stainless Steel Construction
- Gold Standard Lifetime Warranty on Cooking Grates, Burners, Burner Covers, Valves, Flame Tamers, Heatzone Separators & Temperature Gauges
- 3 Year Warranty on all other Parts, Components, & Electrical, including: LED Bulbs, Wire Harness, Switches; Power Source Wire; Transformer; Interior Halogen Light Wire & Bulb

VENT HOODS, REFRIGERATION, COLD STORAGE & SINKS

VENT HOODS

- 5 Year Warranty on all Stainless Steel Construction
- 3 Year Warranty on Blowers, LED Lighting, Wiring Harness and Switches

15" & 24" REFRIGERATION MODELS

- 3 Year Warranty on all construction including Compressors
- 1 Year Warranty on Transformer, LED Bulbs, LED Harness, Power Source Wire, LED Switches, Interior Halogen Light Wire/Bulbs

21" REFRIGERATION MODELS

- 1 Year Warranty on all Construction & Electrical components including Compressor, Transformer, LED Bulbs, LED Harness, Power Source Wire, LED Switches, Interior Halogen Light Wire/Bulbs

COLD STORAGE & SINKS

- Gold Standard Lifetime Warranty on Ice Chest
- Gold Standard Lifetime Warranty on Drains & Faucets

DRAWERS, DOORS, GRILL LINERS, & CARTS

- Gold Standard Lifetime Warranty on Construction, Workmanship and Materials for all Stainless Steel parts, Including Doors, Drawers, Grill Liners, & Carts
- 3 Year Warranty on Electrical (Warming Drawers)

COVERS

- Gold Standard Lifetime Warranty on Covers, including Grills, Carts, Side/Power Burners, Gas Griddle

COMMERCIAL APPLICATIONS

GAS GRILLS

- Gold Standard Lifetime Warranty on Workmanship, Construction, & manufacturer defects for all commercial and/or hospitality applications
- Warranty is void upon misuse, including lack of regular cleaning, vandalism, or theft
- Warranty is valid only if regular maintenance is exercised. Due to the nature of commercial applications (multiple users, lack of control of use, etc.) regular maintenance is mandatory

