

Dell PowerEdge RAID Controller (PERC) 9 User's Guide

Regulatory Model: UCPA-901, UCPB-900, UCSA-901,
UCSB-900, UCSE-900, and UCPE-900



Notes, cautions, and warnings

 **NOTE:** A NOTE indicates important information that helps you make better use of your computer.

 **CAUTION:** A CAUTION indicates either potential damage to hardware or loss of data and tells you how to avoid the problem.

 **WARNING:** A WARNING indicates a potential for property damage, personal injury, or death.

Copyright © 2015 Dell Inc. All rights reserved. This product is protected by U.S. and international copyright and intellectual property laws. Dell™ and the Dell logo are trademarks of Dell Inc. in the United States and/or other jurisdictions. All other marks and names mentioned herein may be trademarks of their respective companies.

2015 - 12

Rev. A05

Contents

1 Overview.....	10
Supported operating systems.....	15
PERC card specifications.....	16
Management applications for PERC cards.....	18
Comprehensive embedded management	18
Dell OpenManage Storage Management.....	18
Related documentation.....	19
2 Getting started with your PERC card.....	20
Installing the operating system and the PERC card on a base system.....	20
Installing the PERC card on a system with the operating system pre-installed.....	21
Installing the operating system on a system with the PERC card pre-installed.....	22
Setting up the system with the PERC card and the operating system pre-installed	23
Configuring settings of a replaced PERC card on a system with operating system pre-installed.....	24
3 Features.....	26
Enhanced rebuild prioritization.....	26
Redundant path support for PERC H830.....	26
Setting up redundant path support on the PERC H830 adapter.....	26
Reverting to single path support from redundant path support for PERC H830.....	28
4KB block size disk drives.....	28
Adapter at baseport not responding error message.....	28
BIOS Configuration Utility.....	28
BIOS disabled error message.....	28
Break mirror.....	29
Break mirror in BIOS configuration utility.....	29
Configured disks removed or not accessible error message.....	29
Configuring FastPath-capable virtual disks.....	30
Controller Management.....	30
Controller management (Ctrl Mgmt).....	30
Controller management actions.....	30
Dirty cache data error message.....	31
Discovery error message.....	32
Drive Configuration Changes Error Message.....	32
Enhanced rebuild prioritization.....	32
Exiting the Configuration Utility.....	32
Extra enclosure error message.....	33

FastPath.....	33
Firmware fault state error message.....	33
Foreign configuration found error message.....	33
Foreign configuration not found in <ctrl> <R> error message.....	34
Foreign configuration view.....	34
Importing or clearing foreign configurations using the foreign configuration view screen.....	34
Rapid rebuild.....	36
240 virtual disk support for H830.....	36
PERC 9 personality management.....	36
Redundant path support for PERC H830.....	36
T10 protection information.....	37
Enabling T10 PI.....	37
Disabling T10 PI.....	37
Secure firmware update.....	37
Improved RAID 10 configuration.....	38
4KB block size disk drives.....	38
Physical disk power management.....	38
Configured spin down delay.....	38
Types of virtual disk initialization.....	39
Full initialization.....	39
Fast initialization.....	39
Background initialization.....	39
Consistency checks.....	40
Disk roaming.....	40
Using disk roaming.....	40
FastPath.....	41
Configuring FastPath-capable virtual disks.....	41
Virtual disk migration.....	41
Migrating virtual disks.....	42
Virtual disk write cache policies.....	42
Conditions under which write-back is employed.....	43
Conditions under which forced write-back with no battery is employed.....	43
Virtual disk read cache policies.....	43
Reconfiguration of virtual disks.....	43
Fault tolerance.....	46
The SMART Feature.....	46
Patrol Read.....	47
Physical disk failure detection.....	47
Using persistent hot spare slots.....	47
Physical disk hot swapping.....	48
Using replace member and revertible hot spares.....	48
Controller cache preservation.....	48

Battery Transparent Learn Cycle.....	49
Non-RAID disks support.....	49
4 Deploying the PERC card.....	51
Removing the PERC 9 adapter.....	51
Installing the PERC 9 adapter.....	53
Removing the PERC 9 mini monolithic controller.....	53
Replacing the battery of a H730P mini monolithic card.....	54
Installing the PERC 9 mini monolithic controller.....	56
Removing a H730P slim card.....	57
Installing a H730P slim card.....	59
Removing the PERC 9 mini blade controller.....	60
Replacing the tethered battery of a PERC 9 mini blade card.....	61
Installing the PERC 9 mini blade controller.....	65
Removing the PERC FD33xD Card.....	66
Replacing the battery of a PERC FD33xD card.....	67
Installing the PERC FD33xD card.....	68
5 Driver installation.....	70
Creating the device driver media.....	70
Downloading drivers from the Dell support website.....	70
Downloading drivers from the Dell systems service and diagnostic tools media	71
Windows driver installation.....	71
Installing the driver during a Windows Server 2008 R2 and newer installation.....	71
Installing the driver after Windows Server 2008 R2 and newer installation	71
Updating PERC 9 driver for existing Windows Server 2008 R2 and newer.....	72
Linux driver installation.....	72
Installing or updating the RPM driver package with KMOD support.....	73
Installing or updating the RPM driver package with KMP support.....	73
6 BIOS Configuration Utility.....	74
Entering the BIOS Configuration Utility.....	74
Exiting the Configuration Utility.....	74
Menu navigation controls.....	75
Setting up virtual disks.....	76
BIOS Configuration Utility menu options.....	78
Virtual disk management.....	78
Virtual disk actions.....	80
Physical disk management (PD Mgmt).....	81
Physical disk actions.....	81
Rebuild.....	82
Controller management (Ctrl Mgmt).....	82

Controller management actions.....	82
Foreign configuration view.....	83
Virtual Disk Management.....	84
Creating virtual disks.....	84
Selecting virtual disk parameters.....	85
Initializing virtual disks.....	85
Checking data consistency.....	86
Running a data consistency check.....	86
Importing or clearing foreign configurations using the VD mgmt menu.....	86
Importing or clearing foreign configurations using the foreign configuration view screen.....	87
Break mirror.....	88
Managing preserved cache.....	89
Managing dedicated hot spares.....	90
Deleting virtual disks.....	90
Deleting disk groups.....	91
Clearing the configuration.....	91
Physical Disk Management.....	91
Setting LED blinking.....	91
Creating global hot spares.....	92
Removing global or dedicated hot spares.....	92
Replacing an online physical disk.....	92
Restrictions and limitations.....	93
Stopping background initialization.....	93
Performing a manual rebuild of an individual physical disk.....	93
Controller Management.....	94
Enabling boot support.....	94
Enabling boot support for a BIOS-enabled controller.....	94
Enabling BIOS stop on error.....	94
Disabling BIOS stop on error.....	95
Enabling auto import.....	95
Disabling auto import.....	95
Restoring factory default settings.....	95
7 UEFI/HII RAID configuration utility.....	96
Entering the UEFI configuration utility.....	96
Exiting the UEFI configuration utility.....	96
Navigating to Dell PERC 9 configuration utility.....	96
Configuration management.....	97
Creating virtual disks.....	97
Creating profile based virtual disks.....	98
Converting physical disks to RAID capable disk.....	98
Converting physical disks to non-RAID disk.....	98

Viewing disk group properties.....	98
Viewing disk group properties.....	98
Managing foreign configurations on a RAID controller.....	99
Deleting existing configurations on a RAID controller.....	99
Controller management.....	99
Restoring factory settings for the controller.....	99
Saving controller events.....	99
Enabling security for the controller.....	100
Saving debug log.....	100
Switching the controller to HBA mode.....	100
Switching the controller to RAID mode.....	101
Virtual disk management.....	101
Viewing virtual disk properties.....	101
Viewing physical disks associated with a virtual disk.....	101
Physical disk management.....	102
Viewing physical disk properties.....	102
Hardware components management.....	102
Viewing battery properties.....	102
Viewing physical disks associated with an enclosure.....	103
Configuring FastPath-capable virtual disks.....	103
Controller Management.....	103
Controller management (Ctrl Mgmt).....	103
Controller management actions.....	103
Dirty cache data error message.....	104
Discovery error message.....	105
Drive Configuration Changes Error Message.....	105
8 Security key and RAID management.....	106
Security key implementation.....	106
Security key management in the BIOS configuration utility.....	106
Local Key Management (LKM).....	107
Creating a security key.....	107
Changing the security key.....	107
Deleting a security key.....	108
Creating secured virtual disks.....	108
Securing pre-existing virtual disks.....	108
Importing or clearing secured foreign configurations and secure disk migration.....	109
Instant secure erase.....	110
9 Troubleshooting.....	111
BIOS configuration utility error messages.....	111
Discovery error message.....	111

Extra enclosure error message.....	111
Missing disks in virtual disk error message.....	111
Previous configuration of disks removed error message.....	112
Missing virtual disks error message.....	112
Dirty cache data error message.....	112
BIOS disabled error message.....	113
Drive Configuration Changes Error Message.....	113
Adapter at baseport not responding error message.....	113
Offline or missing virtual drives with preserved cache error message.....	113
Virtual disks offline error message.....	114
Virtual disks degraded error message.....	114
Virtual disks partially degraded error message.....	114
Memory or battery problem error message.....	114
Firmware fault state error message.....	115
Foreign configuration found error message.....	115
Foreign configuration not found in <ctrl> <R> error message.....	115
Previous configuration cleared or missing error message.....	116
Invalid SAS topology detected error message.....	116
Configured disks removed or not accessible error message.....	116
Degraded state of virtual disks.....	116
Memory errors.....	116
Preserved Cache State.....	117
Security key errors.....	117
Secured foreign import errors.....	117
Failure to select or configure non Self-Encrypting Disks (non-SED).....	117
Failure to delete security key.....	118
Failure to instant secure erase task on physical disks.....	118
General issues.....	118
PERC card has yellow bang in device manager.....	118
PERC card not seen in device manager.....	118
Physical disk issues.....	118
Physical disk in failed state.....	118
Unable to rebuild a fault tolerant virtual disk.....	119
Fatal error or data corruption reported.....	119
Physical disk displayed as blocked.....	119
Multiple disks become inaccessible.....	119
Rebuilding a failed physical disk.....	120
Virtual disk fails during rebuild using a global hot spare.....	120
Virtual disk fails during rebuild using a dedicated hot spare.....	120
Physical disk fails during reconstruction on redundant virtual disk.....	120
Virtual disk fails rebuild using a dedicated hot spare.....	120
Physical disk takes a long time to rebuild.....	120

SMART errors.....	121
Smart error detected on a physical disk in a redundant virtual disk.....	121
Smart error detected on a physical disk in a non-redundant virtual disk.....	121
Replace member errors.....	121
Source disk fails during replace member operation.....	122
Target disk fails.....	122
General disk fails.....	122
Linux operating system errors.....	122
Virtual disk policy is assumed as write-through error message.....	122
Unable to register SCSI device error message.....	122
Disk Carrier LED Indicators.....	123
UEFI error messages.....	123
Unhealthy Status of the Drivers.....	123
10 Appendix: RAID description.....	125
Summary of RAID levels.....	125
RAID terminology.....	125
Disk striping.....	125
Disk mirroring.....	126
Spanned RAID levels.....	126
Parity data.....	127
11 Getting help.....	128
Contacting Dell.....	128
Documentation feedback.....	128
Locating Service Tag of your system.....	128

Overview

The Dell PowerEdge Expandable RAID Controller (PERC) 9 Series of cards consist of the H330, H730, H730P, and H830 cards.

- **PERC H330:** The PERC H330 is a general purpose RAID solution card. The card is available in Adapter (low profile and full height), Mini Monolithic, and Mini Blade form factors for internal storage and tape devices.

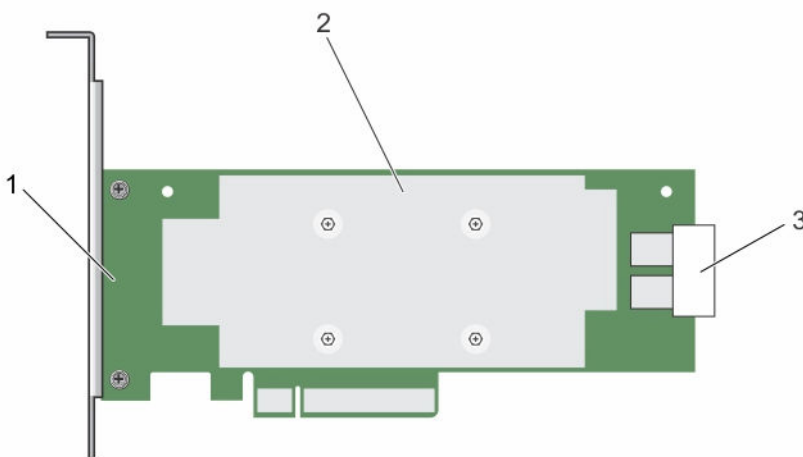

Figure 1. Features of PERC H330 adapter card

1. PERC H330 adapter
2. heat sink
3. SAS cable connectors

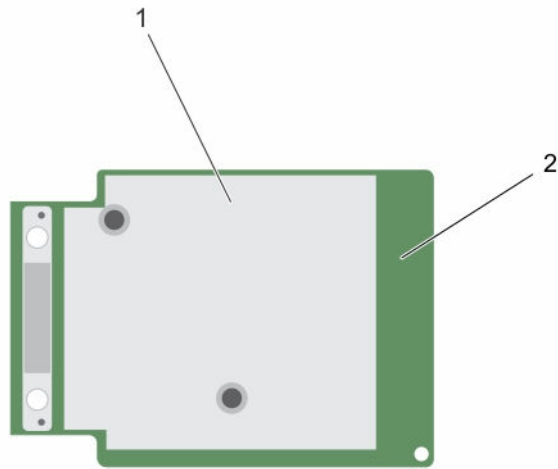

Figure 2. Features of PERC H330 mini monolithic card

1. heat sink
 2. PERC H330 mini monolithic card
- **PERC H730:** The PERC H730 is a RAID solution card consisting of a minimum of 1 GB Non-Volatile Cache and is available in the Adapter (low profile and full height), Mini Monolithic, and Mini Blade form factors for internal storage.

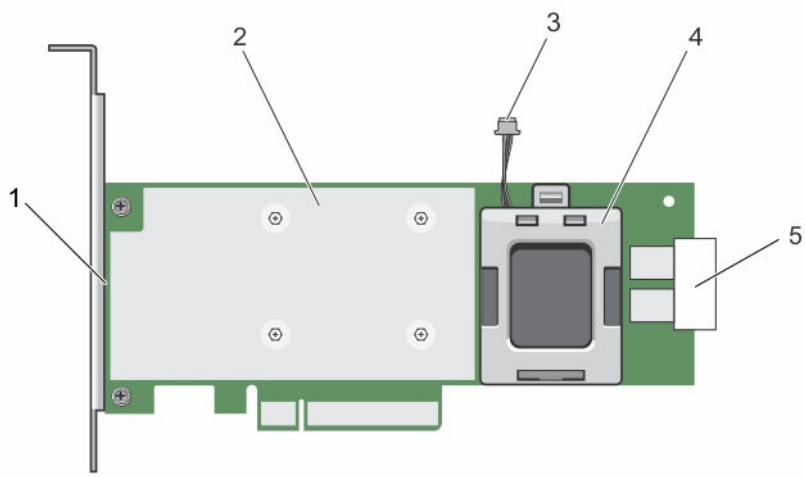

Figure 3. Features of PERC H730 card

- | | |
|-------------------------|--------------------|
| 1. PERC H730 card | 2. heat sink |
| 3. battery cable | 4. battery carrier |
| 5. SAS cable connectors | |

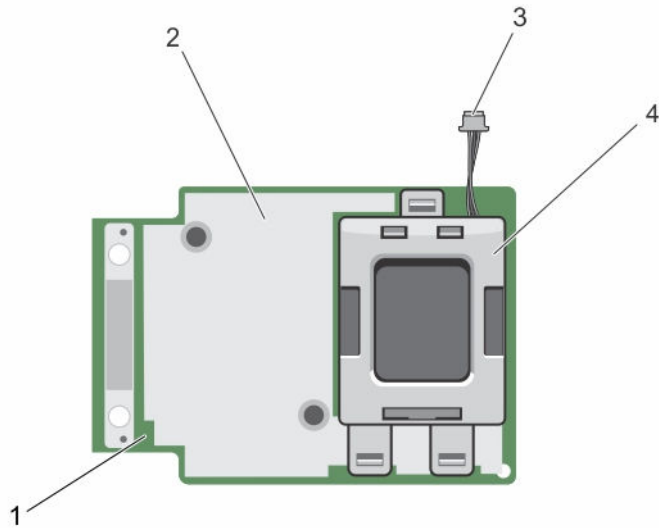

Figure 4. Features of PERC H730/H730P mini monolithic card

- | | |
|-------------------------|--------------------|
| 1. PERC H730/H730P card | 2. heat sink |
| 3. battery cable | 4. battery carrier |
- **PERC H730P:** The PERC H730P is the performance RAID solution card consisting of 2 GB Non-Volatile Cache and is available in the Adapter (low profile and full height), Slim, and Mini Monolithic form factors for internal storage.

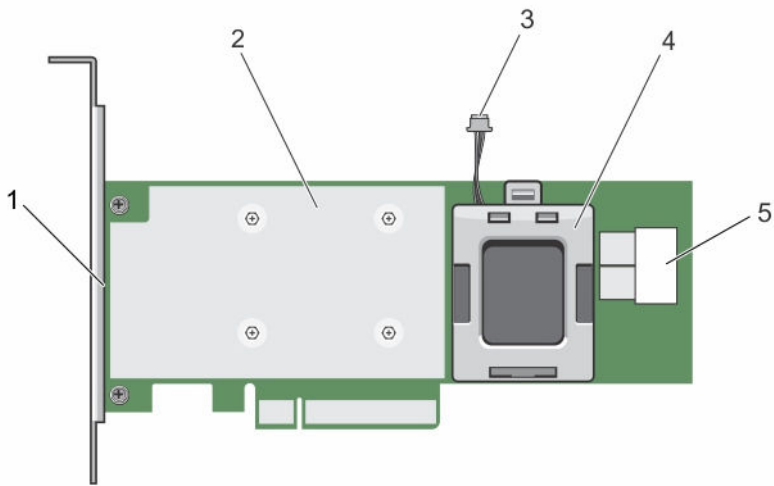

Figure 5. Features of PERC H730P adapter card

- | | |
|-------------------------|--------------------|
| 1. PERC H730P card | 2. heat sink |
| 3. battery cable | 4. battery carrier |
| 5. SAS cable connectors | |
- **PERC H830:** The PERC H830 is similar to the H730P solution, except that it supports external storage. The PERC H830 is only available in the Adapter (low profile and full height) form factor.

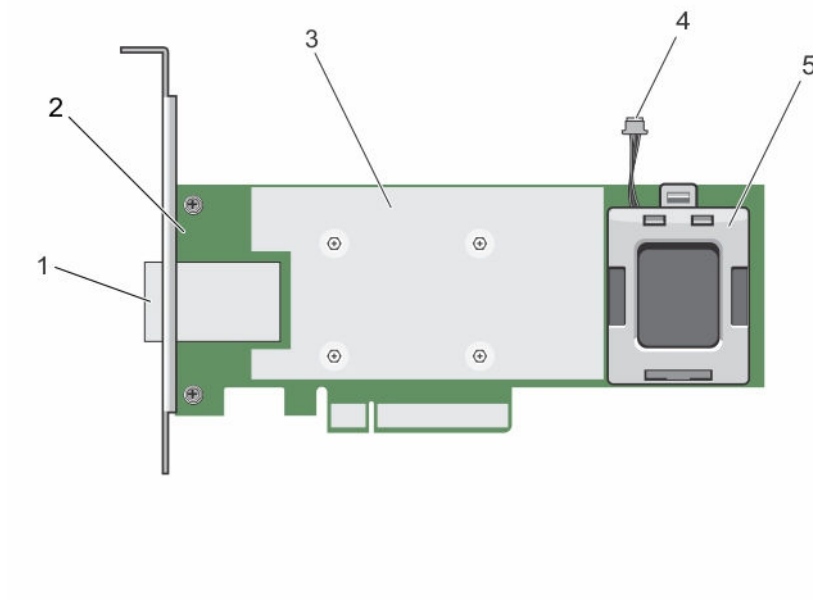



Figure 6. Features of PERC H830 adapter card

- | | |
|----------------------------------|----------------------|
| 1. external SAS cable connectors | 2. PERC H830 adapter |
| 3. heat sink | 4. battery cable |
| 5. battery carrier | |

Supported operating systems

The PERC 9 series cards support the following operating systems:

- Microsoft Windows Server 2012
- Microsoft Windows Server 2012 R2
- Microsoft Windows Server 2008 R2
- Microsoft Windows Server 2008 R2 SP1
- VMware ESXi 5.1 Update 2

 **NOTE:** The PERC 9 driver for VMware ESXi is bundled with the VMware ISO image available from Dell. For more information, see dell.com/virtualizationsolutions.

- VMware ESXi 6
- VMware ESXi 5.5 Update 2
- Red Hat Enterprise Linux version 6.5 (64-bit)
- Red Hat Enterprise Linux 6.5 for HPC Compute Node

- Red Hat Enterprise Virtualization 4.0 (64-bit)
- SUSE Linux Enterprise Server version 11 SP3 (64-bit)
- Red Hat Enterprise Linux version 7

 **NOTE:** For the latest list of supported operating systems and driver installation instructions, see the system documentation at dell.com/support/manuals. For specific operating system service pack requirements, see the Drivers and Downloads section at dell.com/support/manuals.

PERC card specifications

The table below lists and describes the different PERC cards that comprise the PERC 9 series and their specifications:

Table 1. PERC cards

Feature	PERC H330	PERC H730	PERC H730P	PERC H830	PERC FD33xD/ FD33xS
RAID Levels	0, 1, 5, 10, 50	0, 1, 5, 6, 10, 50, 60	0, 1, 5, 6, 10, 50, 60	0, 1, 5, 6, 10, 50, 60	0, 1, 5, 6, 10, 50, 60
Enclosures per port	Not applicable	Not applicable	Not applicable	8 (4 per port)	Not applicable
Processor	Dell Adapter SAS RAID-on-Chip, 8-port with LSI 3008 chipset	Dell Adapter SAS RAID-on-Chip, 8-port with LSI 3108 chipset	Dell Adapter SAS RAID-on-Chip, 8-port with LSI 3108 chipset	Dell Adapter SAS RAID-on-Chip, 8-port with LSI 3108 chipset	Dell Adapter SAS RAID-on-Chip, 8-port with LSI 3108 chipset
Battery Backup Unit	No	Yes	Yes	Yes	Yes
Non-Volatile cache	None	Yes	Yes	Yes	Yes
Cache policy	No	1 GB DDR3 1333 Mhz cache	2 GB DDR3 1866 Mhz cache	2 GB DDR3 1866 Mhz cache	2 GB DDR3 1866 Mhz cache

Feature	PERC H330	PERC H730	PERC H730P	PERC H830	PERC FD33xD/ FD33xS
	 NOTE: H330 does not support caching, which affects performance in RAID 5 and RAID 50 arrays. For performance sensitive solutions, caching is recommended.				
Cache function	Write Through and No Read Ahead	Write Back, Write Through, No Read Ahead, and Read Ahead	Write Back, Write Through, No Read Ahead, and Read Ahead	Write Back, Write Through, No Read Ahead, and Read Ahead	Write Back, Write Through, No Read Ahead, and Read Ahead
Maximum number of virtual disks	16	64	64	240	64
Maximum number of virtual disks per disk group	16	16	16	16	16
Hot swap devices supported	Yes	Yes	Yes	Yes	Yes
Hardware XOR Engine	No	Yes	Yes	Yes	Yes
Online capacity expansion	Yes	Yes	Yes	Yes	Yes
Dedicated and global hot spare	Yes	Yes	Yes	Yes	Yes
Drives Types	3 Gbps SATA, 6 Gbps SATA/SAS, and 12 Gbps SAS	3 Gbps SATA, 6 Gbps SATA/SAS, and 12 Gbps SAS	3 Gbps SATA, 6 Gbps SATA/SAS, and 12 Gbps SAS	6 Gbps SAS, and 12 Gbps SAS	3 Gbps SATA, 6 Gbps SATA/SAS, and 12 Gbps SAS

Feature	PERC H330	PERC H730	PERC H730P	PERC H830	PERC FD33xD/ FD33xS
PCIe Support	Gen 3	Gen 3	Gen 3	Gen 3	Gen 3
Non-RAID or pass through mode	Yes	Yes	Yes	Yes	Yes

Management applications for PERC cards

Dell OpenManage Storage Management applications enable you to manage and configure the RAID system, create and manage multiple disk groups, control and monitor multiple RAID systems, and provide online maintenance. The management applications for all PERC cards include:

- Comprehensive Embedded Management
- Dell OpenManage Storage Management
- BIOS Configuration Utility (<Ctrl> <R>)
- Unified Extensible Firmware Interface (UEFI) RAID Configuration Utility

 **NOTE:** Dell serial-attached SCSI (SAS) RAID Storage Manager is not supported for Self-Encrypting Disks (SED) management.

Comprehensive embedded management

Comprehensive Embedded Management (CEM) is a storage management solution for Dell systems that enables you to effectively monitor the RAID and network controllers installed on the system using iDRAC without an OS installed on the system.

Using CEM enables you to perform the following:

- Monitor devices without an OS installed on the system.
- Provide a specific location to access monitored data of the storage devices and network cards.
- Allows controller configuration for all the PERC 9 cards (H330, H730, H730P, and H830).

 **NOTE:**

The Comprehensive Embedded Management (CEM) feature is not supported on the Dell PowerEdge R920 servers.

Dell OpenManage Storage Management

The Dell OpenManage Storage Management is a storage management application for Dell systems that provides enhanced features for configuring a system's locally-attached RAID and Non-RAID disk storage. The Dell OpenManage storage management application enables you to perform controller and enclosure functions for all supported RAID controllers and enclosures from a single graphical or command-line interface without using of the controller BIOS utilities. The graphical user interface (GUI) is wizard-driven with features for novice and advanced users, and detailed online help. Using the Dell OpenManage storage management application, you can protect your data by configuring data-redundancy, assigning hot spares, or rebuilding failed physical disks. The command line interface available on selected operating systems to perform RAID management tasks is fully featured and scriptable.

 NOTE: For more information, see the *Dell OpenManage Storage Management User's Guide* at dell.com/openmanagemanuals.

Related documentation

 NOTE:

- For all storage controllers and PCIe SSD documents, go to dell.com/storagecontrollermanuals.
- For all Dell OpenManage documents, go to dell.com/openmanagemanuals.
- For all operating system documents, go to dell.com/operatingsystemmanuals.
- For all PowerEdge documentation, go to dell.com/poweredgemanuals.
- For all PowerVault documentation, go to dell.com/powervaultmanuals.

Getting started with your PERC card

The workflows outlined below list the procedures to getting started with the PERC card, based on your system configuration:

- [Installing the operating system and the PERC card on a base system](#)
- [Installing the PERC card on a system with the operating system pre-installed](#)
- [Installing the operating system on a system with the PERC card pre-installed](#)
- [Setting up the system with the PERC card and the operating system pre-installed](#)
- [Configuring settings of a replaced PERC card on a system with operating system pre-installed](#)

Installing the operating system and the PERC card on a base system

1. Install the PERC 9 card in the system. For more information, see [Deploying the PERC card](#).
2. Download the PERC 9 drivers from the Dell support site. For more information, see [dell.com/support](#).
3. Use any of the PERC management applications to create the virtual disks and RAID configurations you require using the procedures listed below:
 - a. [Importing Or Clearing Secured Foreign Configurations And Secure Disk Migration](#)
 - b. Managing physical disks
 1. [Creating Global Hot Spares](#)
 2. [Creating Security Key](#)
 3. Converting a RAID disk to a Non-RAID disk. For more information, see [Controller management](#).
 4. Converting a Non-RAID disk to a RAID disk. For more information, see [Controller management](#).
 - c. [Creating virtual disks](#)
 - d. Managing virtual disks
 1. [Setting up virtual disks](#)
 2. [Checking Data Consistency](#)
 3. [Managing Preserved Cache](#)
 4. [Initializing virtual disks](#)

5. [Performing Background Initialization](#)
6. [Creating Secured Virtual Disks](#)
7. [Securing Pre-Existing Virtual Disks](#)
- e. Managing controllers through BIOS
 1. [Enabling Boot Support](#)
 2. [Enabling Boot Support For A BIOS-Enabled Controller](#)
 3. [Enabling BIOS Stop On Error](#)
 4. [Enabling Auto Import](#)
4. Install the operating system. For more information, refer to your operating system documentation.
5. Install the operating system drivers for PERC 9.
 - If your operating system is Windows, install the Windows drivers. For more information, see [Windows driver installation](#).
 - If your operating system is Linux, install the Linux drivers. For more information, see [Linux driver installation](#).
6. Additionally, you can install and use OpenManage Storage Services to manage the PERC card(s), after the operating system is installed.

Installing the PERC card on a system with the operating system pre-installed

1. Install the PERC 9 card in the system. For more information, see [Deploying the PERC card](#).
2. Download the PERC 9 drivers from the Dell support site. For more information, see [dell.com/support](#).
3. Install the operating system drivers for PERC 9.
 - If your operating system is Windows, install the Windows drivers. For more information, see [Windows driver installation](#).
 - If your operating system is Linux, install the Linux drivers. For more information, see [Linux driver installation](#).
4. Use any of the PERC management applications to create the virtual disks and RAID configurations you require using the procedures listed below:
 - a. [Importing Or Clearing Secured Foreign Configurations And Secure Disk Migration](#)
 - b. Managing physical disks
 1. [Creating Global Hot Spares](#)
 2. [Creating Security Key](#)
 3. Converting a RAID disk to a Non-RAID disk. For more information, see [Controller management](#).
 4. Converting a Non-RAID disk to a RAID disk. For more information, see [Controller management](#).

- c. [Creating virtual disks](#)
 - [Setting up virtual disks](#)
 - d. Managing virtual disks
 1. [Setting up virtual disks](#)
 2. [Checking Data Consistency](#)
 3. [Managing Preserved Cache](#)
 4. [Initializing virtual disks](#)
 5. [Performing Background Initialization](#)
 6. [Creating Secured Virtual Disks](#)
 7. [Securing Pre-Existing Virtual Disks](#)
 - e. Managing Controllers through BIOS
 1. [Enabling Boot Support](#)
 2. [Enabling Boot Support For A BIOS-Enabled Controller](#)
 3. [Enabling BIOS Stop On Error](#)
 4. [Enabling Auto Import](#)
5. Additionally, you can install and use OpenManage Storage Services to manage the PERC card(s).

Installing the operating system on a system with the PERC card pre-installed

1. Use any of the PERC management applications to manage the virtual disks and RAID configurations on your system, using the procedures listed below:
 - a. [Importing Or Clearing Secured Foreign Configurations And Secure Disk Migration](#)
 - b. Managing physical disks
 1. [Creating Global Hot Spares](#)
 2. [Creating Security Key](#)
 3. Converting a RAID disk to a Non-RAID disk. For more information, see [Controller management](#).
 4. Converting a Non-RAID disk to a RAID disk. For more information, see [Controller management](#).
 - c. [Creating virtual disks](#)
 - [Setting up virtual disks](#)
 - d. Managing virtual disks
 1. [Setting up virtual disks](#)
 2. [Checking Data Consistency](#)
 3. [Managing Preserved Cache](#)

4. [Initializing virtual disks](#)
5. [Performing Background Initialization](#)
6. [Creating Secured Virtual Disks](#)
7. [Securing Pre-Existing Virtual Disks](#)
- e. Managing Controllers through BIOS
 1. [Enabling Boot Support](#)
 2. [Enabling Boot Support For A BIOS-Enabled Controller](#)
 3. [Enabling BIOS Stop On Error](#)
 4. [Enabling Auto Import](#)
2. Install the operating system. For more information, refer to your operating system documentation.
3. Install the operating system drivers for PERC 9.
 - If your operating system is Windows, install the Windows drivers. For more information, see [Windows driver installation](#).
 - If your operating system is Linux, install the Linux drivers. For more information, see [Linux driver installation](#).
4. Additionally, you can install and use OpenManage Storage Services to manage the PERC card(s), after the operating system is installed.

Setting up the system with the PERC card and the operating system pre-installed

1. Use any of the PERC management applications to create the virtual disks and RAID configurations you require using the procedures listed below:
 - a. [Importing Or Clearing Secured Foreign Configurations And Secure Disk Migration](#)
 - b. Manage physical disks.
 1. [Creating Global Hot Spares](#)
 2. [Creating Security Key](#)
 3. Converting a RAID disk to a Non-RAID disk. For more information, see [Controller management](#).
 4. Converting a Non-RAID disk to a RAID disk. For more information, see [Controller management](#).
 - c. [Creating virtual disks](#)
 - [Setting up virtual disks](#)
 - d. Managing virtual disks
 1. [Setting up virtual disks](#)
 2. [Checking Data Consistency](#)
 3. [Managing Preserved Cache](#)

4. [Initializing virtual disks](#)
5. [Performing Background Initialization](#)
6. [Creating Secured Virtual Disks](#)
7. [Securing Pre-Existing Virtual Disks](#)
- e. Managing Controllers through BIOS
 1. [Enabling Boot Support](#)
 2. [Enabling Boot Support For A BIOS-Enabled Controller](#)
 3. [Enabling BIOS Stop On Error](#)
 4. [Enabling Auto Import](#)
2. Additionally, you can install and use OpenManage Storage Services to manage the PERC card(s).

Configuring settings of a replaced PERC card on a system with operating system pre-installed

1. Replace your existing PERC card with a new one and install the PERC 9 card in the system. For more information, see [Deploying the PERC card](#).
2. Download the PERC 9 drivers from the Dell support site. For more information, see [dell.com/support](#).
3. Use any of the PERC management applications to create the virtual disks and RAID configurations you require using the procedures listed below:
 - a. [Importing Or Clearing Secured Foreign Configurations And Secure Disk Migration](#)
 - b. Managing physical disks
 1. [Creating Global Hot Spares](#)
 2. [Creating Security Key](#)
 3. Converting a RAID disk to a Non-RAID disk. For more information, see [Controller management](#).
 4. Converting a Non-RAID disk to a RAID disk. For more information, see [Controller management](#).
 - c. [Creating virtual disks](#)
 - [Setting up virtual disks](#)
 - d. Managing virtual disks
 1. [Setting up virtual disks](#)
 2. [Checking Data Consistency](#)
 3. [Managing Preserved Cache](#)
 4. [Initializing virtual disks](#)
 5. [Performing Background Initialization](#)
 6. [Creating Secured Virtual Disks](#)

7. [Securing Pre-Existing Virtual Disks](#)
- e. Managing Controllers through BIOS
 1. [Enabling Boot Support](#)
 2. [Enabling Boot Support For A BIOS-Enabled Controller](#)
 3. [Enabling BIOS Stop On Error](#)
 4. [Enabling Auto Import](#)
4. Additionally, you can install and use OpenManage Storage Services to manage the PERC card(s).

Features

PowerEdge RAID Controller (PERC) 9 series cards support the following features:

- Enhanced rebuild prioritization
- Rapid rebuild
- 240 virtual disk support for H830
- Personality mode management
- T10 Protection Information (PI)
- secure firmware update
- improved RAID 10 configuration
- 4KB block size disk drives

Enhanced rebuild prioritization

If the rebuild rate parameter on Dell PowerEdge RAID Controller (PERC) is set to above 30%, then the PERC modifies the command allocation strategy to prioritize rebuild operations, when the application I/O is consistent in the disk group.

Redundant path support for PERC H830

The PERC H830 adapter can detect and use redundant paths to disks contained in enclosures. This provides the ability to connect two SAS cables between a controller and an enclosure for path redundancy. The controller is able to tolerate the failure of a cable or Enclosure Management Module (EMM) by utilizing the remaining path. When redundant paths exist, the controller automatically balances I/O load through both paths to each disk. Load balancing increases throughput to virtual disks in storage enclosures and is automatically turned on when redundant paths are detected. The ability to load balance I/O can be disabled using the Dell OpenManage storage management application. To set up your hardware to support redundant paths, see [Setting up redundant path support on the PERC H830 adapter](#).

 **NOTE:** This is applicable for PERC H830 only.

 **NOTE:** This support for redundant paths refers to path redundancy only and not to controller redundancy.

Setting up redundant path support on the PERC H830 adapter

The PERC H830 card can detect and use redundant paths to disks contained in enclosures. With redundant paths to the same device, if one path fails, another path can be used to communicate between the controller and the device.

To set up a configuration with redundant paths, both ports on a controller must be cabled to the in ports of a single enclosure. To add multiple enclosures, both out ports (EMM0_Out and EMM1_Out) of the first

enclosure must be cabled to the in ports (EMM3_In and EMM4_In) of the next enclosure. If the connection between an out port on the controller and an in port on an enclosure fails, an alternate path exists through the second out port on the controller and the second in port on the enclosure.

NOTE: The PERC H830 card supports redundant paths when used with Dell PowerVault MD3 series disk storage enclosures.

To Set up an enclosure on the PERC H830 card:

1. Connect two SAS cables from the out ports (EMM0_Out and EMM1_Out) on your PERC H830 card to the in ports (EMM3_In and EMM4_In) of the external enclosure.

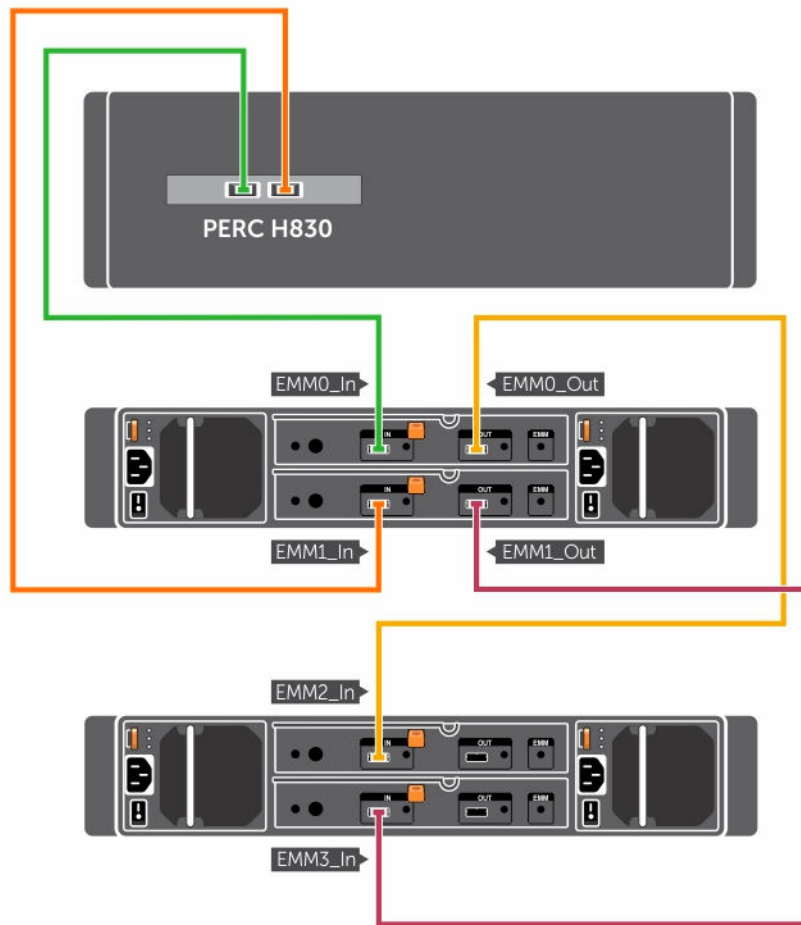

Figure 7. PERC H830 card ports

For information on unified mode, see the enclosure documentation that was shipped with the enclosure.

2. To add multiple enclosures, cable both out ports of the first enclosure to both in ports of the next enclosure.

After you set up the hardware, the controller detects the redundant paths and automatically utilizes them to balance the I/O load.

Reverting to single path support from redundant path support for PERC H830

If you need to revert to single path support from redundant path support, shut down the system and remove the exact same cables that were added to support redundant path support, leaving only one connection between the controller and enclosures. After you remove the cable and turn on the system, ensure that there are no warning messages during boot, and that all virtual disks are online and optimal.

4KB block size disk drives

PERC H330, H730, H730P, H830, FD33xS, and FD33xD cards support 4KB block size disk drives, which enables you to efficiently use the storage space.

 **NOTE:** Mixing 512-byte native and 512-byte emulated drives in a virtual disk is allowed, but mixing 512-byte and 4KB native block size drives in a virtual disk is not allowed.

 **NOTE:** Rapid rebuilding of disk drives is supported on PERC H330, H730, H730P, H830, FD33xS, and FD33xD cards.

Adapter at baseport not responding error message

Error Message: Adapter at Baseport xxxx is not responding, where xxxx is the baseport of the controller.

Corrective Action: Contact Dell Technical Support.

BIOS Configuration Utility

The **BIOS Configuration Utility**, (Ctrl R), is a storage management application embedded on the PERC 9 cards that configure and maintain RAID disk groups and virtual disks. Ctrl R is independent of the operating system.

 **NOTE:** Use the **BIOS Configuration Utility** (Ctrl R) for initial setup and disaster recovery. You can use advanced features through Dell OpenManage storage management application and Dell SAS RAID storage manager.

The following sections provide information about using the **BIOS Configuration Utility** (Ctrl R). For more information, see the online help option by pressing F1 in the **BIOS Configuration Utility** (Ctrl R).

 **NOTE:** The PERC 9 card configuration utility refreshes the screen every 15 seconds to show changes to the information. You can also press F5 to refresh the screen.

BIOS disabled error message

Error Message: BIOS Disabled. No Logical Drives Handled by BIOS.

Probable Cause: This warning message is displayed after you disable the **ROM** option in the configuration utility. When the **ROM** option is disabled, the BIOS cannot boot to Int 13h and cannot provide the ability to boot from the virtual disk. Int 13h is an interrupt signal that supports numerous commands that are sent to the BIOS and then passed to the physical disk. The commands include actions you can perform with a physical disk, such as reading, writing, and formatting.

Corrective Action: Enable the **ROM** option.

Break mirror

A **Break Mirror** is performed only on RAID 1 arrays. It provides a way to 'split' the mirror and spin-down one of the hard disks, which can then be imported into the configuration of a different PERC 9 series controller. This can be a useful way to:

- Create a disk image that can be imported and booted on a different system.
- Assist in software or configuration testing, where half of the mirror can be removed to ensure configuration consistency.

 **NOTE:** The **Break Mirror** operation is not available within the booted operating system environment. It is only available in the **BIOS Configuration Utility** (<Ctrl> <R>) utility and the UEFI RAID configuration utility.

Break mirror in BIOS configuration utility

The RAID 1 virtual disk that you wish to split must be in an optimal state, and it cannot be running any other background tasks.

To use the **Break Mirror** feature, from the **BIOS Configuration Utility** Ctrl R, perform the following steps:

1. During boot up, press Ctrl R when prompted by the BIOS screen. If there is more than one controller in the system, choose the controller.

The **VD Mgmt** screen is displayed by default.

2. Highlight the appropriate **Disk Group**
3. Press F2 to display the available actions.
4. Choose **Break Mirror** and press <Enter>.

A dialog box is displayed describing the operation and asking if you are sure you want to perform the operation.

5. Select **Yes** to continue.

The exported disk (exporting configuration) spins down and the hard drive status LED starts flashing to identify which drive must be removed.

The remaining disk (exporting configuration) is in a degraded state until the missing member is replaced or rebuilt.

If there are any **Global or Dedicated Hot** Spare assigned, which fulfills the rebuild requirements for the degraded RAID 1 disk, a rebuild starts automatically. If there is no hot spare assigned, then an hot spare that meets all the requirements for the virtual disk must be assigned before the rebuild starts.

 **NOTE:** Importing a broken mirror is the same as importing a foreign configuration. See [Importing Or Clearing Foreign Configurations Using VD Mgmt Menu](#). The imported virtual disk is in a degraded state until the missing member is rebuilt.

Configured disks removed or not accessible error message

Error Message: Some configured disks have been removed from your system or are no longer accessible. Check your cables and ensure all disks are present. Press any key or 'C' to continue.

Probable Cause: The message indicates that some configured disks were removed. If the disks were not removed, they are no longer accessible. The SAS cables for your system might be improperly connected.

Corrective Action: Check the cable connections and fix issues if any. Restart the system. If there are no cable problems, press any key or <C> to continue.

Configuring FastPath-capable virtual disks

All simple virtual disks configured with write cache policy Write Through and read cache policy No Read Ahead can utilize FastPath. Only IO block sizes smaller than virtual disk's stripe size are eligible for FastPath. In addition, there should be no background operations (rebuild, initialization) running on the virtual disks. FastPath will not be used if these operations are active.

 **NOTE:** RAID 50, and RAID 60 virtual disks cannot use FastPath.

The following table summarizes the FastPath-eligibility of read and write IOs across the supported RAID levels.

Table 2. FastPath eligibility across supported RAID levels

	RAID 0	RAID 1	RAID 5	RAID 6	RAID 10
Read	Yes	Yes (Optimal and Degraded)	Yes (Optimal and Degraded)	Yes (Optimal and Degraded)	Yes (Optimal)
Write	Yes	No	No	No	No

Controller Management

Controller management (Ctrl Mgmt)

The **Controller Management** screen (**Ctrl Mgmt**) displays the product name, package, firmware version, BIOS version, boot block version, controller ID, security capability, and security key presence. Use the screen to perform actions on the controller and BIOS. You can perform functions such as enable or disable the controller BIOS, enable or disable the BIOS during bootup in the event of BIOS errors, and enable or disable the option to **Auto Import**. In addition, you can select a virtual disk from which to boot, and select default settings.

Controller management actions

The following table describes the actions you can perform on the **Ctrl Mgmt** screen.

Table 3. Controller management options

Option	Description
Enable Controller BIOS	Select the option to enable the controller BIOS. If the boot device is on the RAID controller, the BIOS must be enabled.

Option	Description
	<p>Disable the BIOS to use other boot devices.</p> <p>In a multiple controller environment, you can enable the BIOS on multiple controllers. However, if you want to boot from a specific controller, then enable the BIOS on that controller and disable it on the other controllers. The system can then boot from the BIOS-enabled controller.</p>
Enable BIOS Stop On Error	<p>Select the option to stop the system BIOS during bootup if there are BIOS errors. The option enables you to enter the configuration utility to resolve the problem.</p> <p> WARNING: Do not enable the BIOS Stop On Error option when the system is operating in UEFI mode.</p>
Select Bootable Device	<p>Select the option to specify a virtual disk as the boot disk on the controller.</p> <p>The option is displayed if you have built virtual disks.</p>
Enable Auto Import	<p>Attempts to import every online foreign configuration during boot without having the need to access the BIOS Configuration Utility (<Ctrl><R>).</p>
Factory Default Personality Mode	<p>Select the option to restore the default settings for the options in the Settings box.</p> <p>Select this option to switch to the HBA mode. the default mode is RAID-mode.</p>

Dirty cache data error message

Error Message: The following virtual disks are missing: (x). If you proceed (or load the configuration utility), these virtual disks will be removed from your configuration. If you wish to use them at a later time, they will have to be imported. If you believe these virtual disks should be present, please power off your system and check your cables to ensure all disks are present. Press any key to continue, or 'C' to load the configuration utility. The cache contains dirty data, but some virtual disks are missing or will go offline, so the cached data cannot be written to disk. If this is an unexpected error, then please power off your system and check your cables to ensure all disks are present. If you continue, the data in cache will be permanently discarded. Press 'X' to acknowledge and permanently destroy the cached data.

Probable Cause: The controller preserves the dirty cache from a virtual disk if the disk becomes offline or is deleted because of missing physical disks. This message indicates that some configured disks were removed. If the disks were not removed, they are no longer accessible. The SAS cables for your system might be improperly connected.

Corrective Action: Check the cable connections and fix any problems. Restart the system. Use the <Ctrl> <R> utility to import the virtual disk or discard the preserved cache. For the steps to manage preserved cache, see [Managing The Preserved Cache](#).

Discovery error message

Error Message: A discovery error has occurred, please power cycle the system and all the enclosures attached to this system.

Probable Cause: This message indicates that discovery did not complete within 120 seconds. The SAS cables for your system might be improperly connected.

Corrective Action: Check the cable connections and fix any problems. Restart the system.

Drive Configuration Changes Error Message

Error Message: Entering the configuration utility in this state will result in drive configuration changes. Press 'Y' to continue loading the configuration utility or please power off your system and check your cables to ensure all disks are present and reboot.

Probable Cause: The message is displayed after another BIOS warning indicating there are problems with previously configured disks and you have chosen to accept any changes and continue. The SAS cables for your system might be improperly connected.

Corrective Action: Check the cable connections and fix any problems before restarting the system. If there are no cable problems, press any key or <Y> to continue.

Enhanced rebuild prioritization

If the rebuild rate parameter on Dell PowerEdge RAID Controller (PERC) is set to above 30%, then the PERC modifies the command allocation strategy to prioritize rebuild operations, when the application I/O is consistent in the disk group.

Exiting the Configuration Utility

To exit the **BIOS Configuration Utility** (<Ctrl> <R>)

1. Press <Esc> on any menu screen.
If there is only one controller, then a dialog box is displayed to confirm your choice.
2. Select **OK** to exit and press <Enter>.
If multiple controllers are present, then the <Esc> key brings you to the **Controller Selection** screen.
3. Press <Esc> again to reach the exit screen.
A dialog box is displayed to confirm your choice.
4. Select **OK** to exit and press <Enter>.

Extra enclosure error message



- Error Message:** There are X enclosures connected to connector Y, but only maximum of 4 enclosures can be connected to a single SAS connector. Please remove the extra enclosures then restart your system.
- Probable Cause:** This message is displayed when the BIOS detects more than four enclosures connected to a single SAS connector.
- Corrective Action:** You must remove all additional enclosures and restart your system.

FastPath

FastPath is a feature that improves application performance by delivering high I/O per second (IOPs) for the Solid State Drives (SSD). The Dell PowerEdge RAID Controller (PERC) 9 series supports FastPath.

To enable **FastPath** on a virtual disk the Dell PowerEdge RAID Controller (PERC) 9 series cache policies need to be set to **Write-Through** and **No Read Ahead**. This enables **FastPath** to use the proper data path through the controller based on command (read/write), IO size, and RAID type.

For small random workloads, like OLTP, a RAID 10 array provides high performance and for sequential read dominant workloads, a RAID5 array provides high performance.

-  **NOTE:** Only IO block sizes smaller than virtual disk's stripe size are eligible for **FastPath**.
-  **NOTE:** The Physical Disk Power Management feature is not applicable to FastPath-capable virtual disks.

Firmware fault state error message

- Error Message:** Firmware is in Fault State.
- Corrective Action:** Contact Dell Technical Support.

Foreign configuration found error message

- Error Message:** Foreign configuration(s) found on adapter. Press any key to continue, or 'C' to load the configuration utility or 'F' to import foreign configuration(s) and continue.
- Probable Cause:** When a controller firmware detects a physical disk with existing foreign metadata, it flags the physical disk as *foreign* and generates an alert indicating that a foreign disk was detected.
- Corrective Action:** Press <F> at this prompt to import the configuration (if all member disks of the virtual disk are present) without loading the **BIOS Configuration Utility** (<Ctrl> <R>). Or press <C> to enter the **BIOS Configuration Utility** (<Ctrl> <R>) and either import or clear the foreign configuration.

Foreign configuration not found in <ctrl> <R> error message

Error Message: The foreign configuration message is present during POST but no foreign configurations are present in the foreign view page in <Ctrl> <R>. All virtual disks are in an optimal state.

Corrective Action: Ensure all your PDs are present and all VDs are in optimal state. Clear the foreign configuration using <Ctrl> <R> or **Dell OpenManage Server Administrator Storage Management**.

 **CAUTION: The physical disk goes to Ready state when you clear the foreign configuration.**

If you insert a physical disk that was previously a member of a virtual disk in the system, and that disk's previous location has been taken by a replacement disk through a rebuild, you must manually remove the foreign configuration flag of the newly inserted disk.

Foreign configuration view

When a foreign configuration is present, you can select **Foreign Configuration View** to display the configuration. The screen shows the foreign configuration as it would be if you import it. You can preview the foreign configuration before you decide whether to import it or clear it.

In some cases, a foreign configuration cannot be imported. If a physical disk in a virtual disk is rebuilding, the physical disk's state is set to **Rebuild**. Virtual disks that cannot be imported do not display the virtual disk target id.

The section Importing or Clearing Foreign Configurations Using the Foreign Configuration View Screen contains the procedures you can use to manage the foreign configurations.

 **NOTE:** The **BIOS Configuration Utility** (<Ctrl> <R>) reports error codes for failed imports of foreign configurations.

Importing or clearing foreign configurations using the foreign configuration view screen

 **NOTE:** To import a secured foreign configuration, see [Security Key And RAID Management](#).

If one or more physical disks are removed from a configuration, the configuration on those disks is considered a foreign configuration by the RAID controller.

You can use the **Foreign Config** screen to view information about the foreign configuration, such as disk groups, virtual disks, physical disks, space allocation, and hot spares. The foreign configuration data is displayed in the same format as configurations on the **VD Mgmt** screen. You can use the **VD Mgmt** screen to view the foreign configuration before importing. After you view the foreign configuration, you can either clear or import to the RAID controller.

 **NOTE:** Before you import the foreign configuration, review the configuration on the screen to ensure that it is the end result that you require.

You can use the **Foreign Config** screen to manage foreign configurations in the following cases:

- All the physical disks in a configuration are removed and re-inserted.
- Some of the physical disks in a configuration are removed and re-inserted.
- All the physical disks in a virtual disk are removed, but at different times, and then re-inserted.
- The physical disks in a non-redundant virtual disk are removed.

The following constraints apply to the physical disks that are considered for import:

- The disk state of a physical disk can change from the time the foreign configuration is scanned to when the actual import occurs. The foreign import occurs only on disks that are in the **Unconfigured Good** state.
- Disks in the failed or offline state cannot be imported.
- The firmware does not allow you to import more than eight foreign configurations.

To manage foreign configurations:

1. If all or some of the physical disks in a configuration are removed and reinserted, the controller considers the disks to have foreign configurations. Perform the following steps:
 - a. Select **Foreign Config** to display the foreign configuration information on the **Foreign Config** screen.
 - b. Press <F2> to display the options (**Import**, **Clear**).
 - ✎ **NOTE:** You must have all the disks in the system before you perform the import operation.
 - c. Select **Import** to import the foreign configuration to the controller or select **Clear** to delete the foreign configuration(s) from the re-inserted disk(s).

In the **Preview Configuration Data** window, the status of a physical disk that needs to be rebuilt is displayed as **Rebuild**.

 - ✎ **NOTE:** When you import a foreign configuration, the dedicated hot spares in the configuration are imported as dedicated hot spares on two conditions – the associated virtual disk is already present or the associated virtual disk is also imported along with the configuration.
 - ✎ **NOTE:** Start a consistency check immediately after the rebuild is complete to ensure data integrity for the virtual disks. For more information about checking data consistency, see [Checking Data Consistency](#).
2. If all the physical disks in a virtual disk are removed at different times and re-inserted, the controller considers the disks to have foreign configurations. Perform the following steps:
 - a. Select **Foreign Configuration View** to display the complete virtual disk, across different foreign configurations and allow foreign configurations to be imported.
 - b. Press <F2> to display the options **Import** and **Clear**.
 - ✎ **NOTE:** You must have all the drives in the system before you perform the import operation.
 - c. Select **Import** to merge the foreign configurations with the existing configuration on the controller or **Clear** to delete the foreign configuration(s) from the re-inserted disk(s).

If you select **Import**, all drives that were removed before the virtual disk became offline are imported, and then automatically rebuilt.

 - ✎ **NOTE:** Start a consistency check immediately after the rebuild is complete to ensure data integrity for the virtual disks. For more information about checking data consistency, see [Checking Data Consistency](#).

3. If the physical disks in a non-redundant virtual disk are removed, the controller considers the disks to have foreign configurations. Perform the following steps:
 - a. Select **Foreign Configuration View** to display the complete foreign configuration information.
 - b. Press <F2> to display the options **Import** and **Clear**.
 - c. Select **Import** to import the foreign configurations to the virtual disk or **Clear** to delete the foreign configuration(s) from the re-inserted disk(s).

No rebuilds occur after the import operation because there is no redundant data to rebuild the disks with.

Rapid rebuild

PERC supports the T10 Rebuild Assist feature. You can perform rebuild operations on the drives that has the Rebuild Assist feature enabled, when the drives are partially operational due to disk failure.

PERC reads the available good data from the failing drive and reduces the impact of the rebuild operation on other drives in the RAID array.

240 virtual disk support for H830

As part of support for automatic configuration of each physical drive that is configured with RAID 0, H830 supports 240 virtual disks. The number of supported virtual disks on H730 and H730P is 64.

PERC 9 personality management

PERC 9 series of cards support two personality modes.

- **RAID mode:** RAID mode is commonly used and the controllers are mostly shipped from the factory in RAID mode. This mode allows the creation and operation of RAID virtual disks and non-RAID disks.
- **HBA mode:** In the HBA mode, PERC controller operates as Host Bus Adapter (HBA). This mode does not contain virtual disks or the ability to create them. All physical disks function as non-RAID disks under operating system control. The PERC card acts as a conduit between the host server and the physical disks. Input and output requests originate from the host and are passed through the controller to the physical drives. HBA mode is the approach used for Windows Storage Spaces.

 **NOTE:** HBA mode should be enabled for customers, using Microsoft Storage Spaces or VMware Virtual SAN. HBA mode allows the operating system to control backplane LED functionality on supported systems.

Redundant path support for PERC H830

The PERC H830 adapter can detect and use redundant paths to disks contained in enclosures. This provides the ability to connect two SAS cables between a controller and an enclosure for path redundancy. The controller is able to tolerate the failure of a cable or Enclosure Management Module (EMM) by utilizing the remaining path. When redundant paths exist, the controller automatically balances I/O load through both paths to each disk. Load balancing increases throughput to virtual disks in storage enclosures and is automatically turned on when redundant paths are detected. The ability to load balance I/O can be disabled using the Dell OpenManage storage management application. To set up your hardware to support redundant paths, see [Setting up redundant path support on the PERC H830 adapter](#).

 **NOTE:** This is applicable for PERC H830 only.

 **NOTE:** This support for redundant paths refers to path redundancy only and not to controller redundancy.

T10 protection information

T10 Protection Information (PI) is an end-to-end data integrity feature of the PERC 9 series. When PI is enabled, the PERC 9 series provides additional protection against silent data corruption, and ensures that incomplete and incorrect data do not overwrite good data.

Only Dell certified PI disks are supported.

 **NOTE:** PI is not supported on SAS disks with 512-byte native and 512-byte emulated block size and SATA disks.

Enabling T10 PI

To enable T10 PI:

1. During host system boot, press <Ctrl> <R> to access the **BIOS Configuration Utility**.
The **Virtual Disk Management** screen is displayed in the **BIOS Configuration Utility** window.
If there is more than one controller, the main menu screen is displayed. Select a controller, and press <Enter>. The **Virtual Disk Management** screen is displayed for the selected controller.
2. Use the arrow keys to highlight the PERC 9 series of cards or **Disk Group #**.
 **NOTE:** The H330 PERC card does not support the T10 PI feature.
3. Press <F2>.
The list of available actions is displayed.
4. Click **Enable Data Protection**.

Disabling T10 PI

To disable T10 PI:

1. Press <F2>.
The list of available actions is displayed.
2. Click **Disable Data Protection**.

Secure firmware update

This feature provides a cryptographic method of updating the firmware using RSA encryption-decryption algorithm.

Only Dell certified firmware is supported on your PERC controller.

Improved RAID 10 configuration

RAID 10 configuration has been simplified for easier management and deployment. Disks are selected in mirrored pairs.

 **NOTE:** An even number of drives is required to create RAID 10 virtual disks.

4KB block size disk drives

PERC H330, H730, H730P, H830, FD33xS, and FD33xD cards support 4KB block size disk drives, which enables you to efficiently use the storage space.

 **NOTE:** Mixing 512-byte native and 512-byte emulated drives in a virtual disk is allowed, but mixing 512-byte and 4KB native block size drives in a virtual disk is not allowed.

 **NOTE:** Rapid rebuilding of disk drives is supported on PERC H330, H730, H730P, H830, FD33xS, and FD33xD cards.

Physical disk power management

Physical disk power management is a power-saving feature of the PERC 9 series cards. The feature allows disks to be spun down based on disk configuration and I/O activity. The feature is supported on all rotating SAS and SATA disks and includes unconfigured, configured, and hot-spare disks. The physical disk power management feature is disabled by default. The feature can be enabled in the Dell Open Manage Storage Management application or **Unified Extensible Firmware Interface (UEFI) RAID Configuration** utility. For more information, see the Dell OpenManage documentation at Dell.com/openmanagemanuals.

There are four power-saving modes:

No Power Savings All power savings features are disabled.
(default mode)

Balanced Power Savings Spin down is enabled only for unconfigured and hot spare disks.

Maximum Power Savings Spin down is enabled for configured, unconfigured, and hot spare disks.

 **NOTE:** The maximum power savings mode is not supported by the H330 PERC card.

Customized Power Savings All power savings features are customizable. You can specify a **Quality of Service** window during which the configured disks are excluded from spin-down.

 **NOTE:** The customized power savings mode is not supported by the H330 PERC card.

Configured spin down delay

 **NOTE:** The **Configured Spin Down Delay** option is not applicable for the **No Power Savings** mode.

The amount of time to wait before spinning down disks can be set using **Configured Spin Down Delay**. The minimum value of the timer is 30 minutes (default) and the maximum is one day. Disks are spun down automatically and spun up when accessed. All disks are spun up on reboot.

 **NOTE:** There is a delay in I/O operations when a configured disk is being spun up.

Types of virtual disk initialization

PERC 9 series supports two types of virtual disk initialization:

- Full Initialization
- Fast Initialization

 **CAUTION:** Initializing virtual disks erases files and file systems while keeping the virtual disk configuration intact.

 **NOTE:** The following initialization operations are not applicable for non-RAID disks.

Full initialization

Performing a full initialization on a virtual disk overwrites all blocks and destroys any data that previously existed on the virtual disk. Full initialization of a virtual disk eliminates the need for the virtual disk to undergo a Background initialization (BGI). Full initialization can be performed after the virtual disk is created.

During full initialization, the host cannot access the virtual disk. You can start a full initialization on a virtual disk by using the **Slow Initialize** option in the Dell OpenManage storage management application. For more information on using the **BIOS Configuration Utility** to perform a full initialization, see [Initializing virtual disks](#).

 **NOTE:** For better performance, you can perform full initialization on virtual disks. Full initialization does not support RAID 6 and RAID 60 virtual disks with the PI feature enabled. BGI runs instead.

 **NOTE:** If the system reboots during a full initialization, the operation aborts and a BGI begins on the virtual disk.





Fast initialization

A fast initialization on a virtual disk overwrites the first and last 8 MB of the virtual disk, clearing any boot records or partition information. The operation takes only 2–3 seconds to complete, but it is followed by BGI, which takes a longer time to complete. To perform a fast initialization using the **BIOS Configuration Utility**, see [Initializing virtual disks](#).

 **NOTE:** Fast initialization does not support RAID 6 and RAID 60 virtual disks with the PI feature enabled.

Background initialization

Background Initialization (BGI) is an automated process that writes the parity or mirror data on newly created virtual disks. BGI does not run on RAID 0 virtual disks. You can control the BGI rate in the Dell OpenManage storage management application. Any change in the BGI rate does not take effect until the next BGI run.

-  **NOTE:** BGI will run on RAID 0 virtual disks only with PI enabled.
-  **NOTE:** You cannot disable BGI permanently. If you cancel BGI, it automatically restarts within five minutes. For information on stopping BGI, see [Stopping Background Initialization](#).
-  **NOTE:** Unlike full or fast initialization of virtual disks, background initialization does not clear data from the physical disks.
-  **NOTE:** Consistency Check (CC)/BGI typically causes some loss in performance until the operation completes.
-  **NOTE:** VD with PI will have a longer background initialization when compared to non-PI virtual disks.

Consistency Check (CC) and BGI perform similar functions in that they both correct parity errors. However, CC reports data inconsistencies through an event notification, but BGI does not. You can start CC manually, but not BGI.

Consistency checks

Consistency Check (CC) is a background operation that verifies and corrects the mirror or parity data for fault tolerant virtual disks. It is recommended that you periodically run a consistency check on virtual disks.

You can manually start a CC using the **BIOS Configuration Utility** or the Dell OpenManage storage management application. You can schedule a CC to run on virtual disks using the Dell OpenManage storage management application. To start a CC using the **BIOS Configuration Utility**, see [Checking Data Consistency](#).

-  **NOTE:** CC/BGI typically causes some loss in performance until the operation completes.

Consistency Check (CC) and BGI both correct parity errors. However, CC reports data inconsistencies through an event notification, but BGI does not. You can start CC manually, but not BGI.

Disk roaming

Disk roaming is moving the physical disks from one cable connection or backplane slot to another on the same controller. The controller automatically recognizes the relocated physical disks and logically places them in the virtual disks that are part of the disk group. You can perform disk roaming only when the system is turned off.

-  **CAUTION: Do not attempt disk roaming during RAID level migration (RLM) or online capacity expansion (OCE). This causes loss of the virtual disk.**

Using disk roaming

Perform the following steps to use disk roaming:

1. Turn off the power to the system, physical disks, enclosures, and system components.
2. Disconnect power cables from the system.
3. Move the physical disks to desired positions on the backplane or the enclosure.
4. Perform a safety check. Make sure the physical disks are inserted properly.
5. Turn on the system.

The controller detects the RAID configuration from the configuration data on the physical disks.

FastPath

FastPath is a feature that improves application performance by delivering high I/O per second (IOPs) for the Solid State Drives (SSD). The Dell PowerEdge RAID Controller (PERC) 9 series supports FastPath.

To enable **FastPath** on a virtual disk the Dell PowerEdge RAID Controller (PERC) 9 series cache policies need to be set to **Write-Through** and **No Read Ahead**. This enables **FastPath** to use the proper data path through the controller based on command (read/write), IO size, and RAID type.

For small random workloads, like OLTP, a RAID 10 array provides high performance and for sequential read dominant workloads, a RAID5 array provides high performance.

 **NOTE:** Only IO block sizes smaller than virtual disk's stripe size are eligible for **FastPath**.

 **NOTE:** The Physical Disk Power Management feature is not applicable to FastPath-capable virtual disks.

Configuring FastPath-capable virtual disks

All simple virtual disks configured with write cache policy Write Through and read cache policy No Read Ahead can utilize FastPath. Only IO block sizes smaller than virtual disk's stripe size are eligible for FastPath. In addition, there should be no background operations (rebuild, initialization) running on the virtual disks. FastPath will not be used if these operations are active.

 **NOTE:** RAID 50, and RAID 60 virtual disks cannot use FastPath.

The following table summarizes the FastPath-eligibility of read and write IOs across the supported RAID levels.

Table 4. FastPath eligibility across supported RAID levels

	RAID 0	RAID 1	RAID 5	RAID 6	RAID 10
Read	Yes	Yes (Optimal and Degraded)	Yes (Optimal and Degraded)	Yes (Optimal and Degraded)	Yes (Optimal)
Write	Yes	No	No	No	No

Virtual disk migration

The PERC 9 series supports migration of virtual disks from one controller to another without taking the target controller offline. The controller can import RAID virtual disks in optimal, degraded, or partially degraded states. You cannot import a virtual disk that is offline. Disk migration pointers:

- Supports migration of virtual disks from PERC H310, H710, H710P, and H810 to PERC 9 series
- Supports migration of volumes created within PERC 9 series
- Does not support migration from PERC 9 series to H310, H710, H710P, H810

 **NOTE:** The source controller must be offline prior to performing the disk migration.

 **NOTE:** Disks cannot be migrated to older generations of the PERC cards.

 **NOTE:** Importing secured virtual disks is supported as long as the appropriate Local Key Management (LKM) is supplied or configured.

When a controller detects a configured physical disk, it flags the physical disk as foreign, and generates an alert indicating that a foreign disk was detected.

 **CAUTION:** Do not attempt disk migration during RLM or online capacity expansion (OCE). This causes loss of the virtual disk.

Migrating virtual disks

To migrate virtual disks from PERC H710, H710P, or H810 to PERC 9 series:

1. Turn off the system.
2. Ensure that all the latest firmware and drivers for the PERC H330, H730, H730P, or H830 card (available at dell.com/support) are installed on the destination system.
For more information, see [Driver installation](#).
3. Move the physical disks from PERC H310, H710, H710P, or H810 card to the PERC 9 series.
4. Boot the system and import the foreign configuration that is detected. You can do one of the following:
 - Press <F> to automatically import the foreign configuration.
 - Enter the **BIOS Configuration Utility** and navigate to the **Foreign Configuration View**.

 **NOTE:** For more information on accessing the **BIOS Configuration Utility**, see [Entering the BIOS configuration utility](#).

 **NOTE:** For more information on **Foreign Configuration View**, see [Foreign Configuration View](#).

5. Exit the **BIOS Configuration Utility** and reboot the system.

Virtual disk write cache policies

The write cache policy of a virtual disk determines how the controller handles writes to the virtual disk.

Table 5. Write cache policies

Write-Back

The controller sends a data transfer completion signal to the host when the controller cache has received all the data in a transaction. The controller then writes the cached data to the storage device in the background.

 **NOTE:** The default cache setting for virtual disks is **Write-Back** caching. Write-back caching is also supported for single drive RAID 0 virtual disks.

Write-Through

The controller sends a data transfer completion signal to the host system when the disk subsystem has received all the data in a transaction.

All RAID volumes are presented as **Write-Through** to the operating system (Windows and Linux) independent of the actual write cache policy of the virtual disk. The PERC cards manage the data in cache independently of the operating system or any applications.

 **NOTE:** Certain data patterns and configurations perform better with a **Write-Through** cache policy.

 **NOTE:** Use the Dell OpenManage storage management application or the **BIOS Configuration Utility** to view and manage virtual disk cache settings.

Conditions under which write-back is employed

Write-Back caching is used under all conditions in which the battery is present and in good condition.

Conditions under which forced write-back with no battery is employed

 **CAUTION:** It is recommended that you use a power backup system when forcing **Write-Back** to ensure there is no loss of data if the system suddenly loses power.

Write-Back mode is available when you select **Force WB with no battery**. When **Forced Write-Back** mode is selected, the virtual disk is in **Write-Back** mode even if the battery is not present.

Virtual disk read cache policies

The read policy of a virtual disk determines how the controller handles reads to that virtual disk.

Table 6. Read policies

Read Ahead	Allows the controller to read sequentially ahead of requested data and to store the additional data in cache memory, anticipating that the data is required soon. This speeds up reads for sequential data, but there is little improvement when accessing random data.
No Read Ahead	Disables the Read-Ahead capability.

Reconfiguration of virtual disks

An online virtual disk can be reconfigured in ways that expands its capacity and/or change its RAID level.

 **NOTE:** Spanned virtual disks such as RAID 10, 50, and 60 cannot be reconfigured.

 **NOTE:** Reconfiguring **Virtual Disks** typically impacts disk performance until the reconfiguration operation is complete.

Online Capacity Expansion (OCE) can be done in two ways:

- If there is a single virtual disk in a disk group and free space is available, the virtual disk's capacity can be expanded within that free space. If multiple virtual disks exist within a common disk group, those virtual disk's capacities cannot be expanded.
- If a virtual disk is created and it does not use the maximum size of the disk group, free space is available.

Free space is also available when a disk group's physical disks are replaced by larger disks using the **Replace Member** feature. A virtual disk's capacity can also be expanded by performing an OCE operation to add more physical disks.

RAID Level Migration (RLM) refers to changing a virtual disk's RAID level. Both RLM and OCE can be done at the same time so that a virtual disk can simultaneously have its RAID level changed and its capacity increased. When a RLM/OCE operation is complete, a reboot is not required. The source RAID level column indicates the virtual disk RAID level before the RLM/OCE operation and the target RAID level column indicates the RAID level after the RLM/OCE operation.

 **NOTE:** If the controller already contains the maximum number of virtual disks, you cannot perform a RAID level migration or capacity expansion on any virtual disk.

 **NOTE:** The controller changes the write cache policy of all virtual disks undergoing a RLM/OCE operation to **Write-Through** until the RLM/OCE operation is complete.

See the following table for a list of RLM/OCE possibilities.

Table 7. RAID level migration

Source RAID Level	Target RAID Level	Number of Physical Disks (Beginning)	Number of Physical Disks (End)	Capacity Expansion Possible	Description
RAID 0	RAID 0	1	2 or more	Yes	Increases capacity by adding disks.
RAID 0	RAID 1	1	2	No	Converts a non-redundant virtual disk into a mirrored virtual disk by adding one disk.
RAID 0	RAID 5	1 or more	3 or more	Yes	At least one disk needs to be added for distributed parity data.

Source RAID Level	Target RAID Level	Number of Physical Disks (Beginning)	Number of Physical Disks (End)	Capacity Expansion Possible	Description
RAID 0	RAID 6	1 or more	4 or more	Yes	At least two disks need to be added for dual distributed parity data.
RAID 1	RAID 0	2	2 or more	Yes	Removes redundancy while increasing capacity.
RAID 1	RAID 5	2	3 or more	Yes	Maintains redundancy while doubling capacity.
RAID 1	RAID 6	2	4 or more	Yes	Two disks required to be added for distributed parity data.
RAID 5	RAID 0	3 or more	3 or more	Yes	Converts to a non-redundant virtual disk and reclaims disk space used for distributed parity data.
RAID 5	RAID 5	3 or more	4 or more	Yes	Increases capacity by adding disks.
RAID 5	RAID 6	3 or more	4 or more	Yes	At least one disk needs to be added for dual distributed parity data.
RAID 6	RAID 0	4 or more	4 or more	Yes	Converts to a non-redundant virtual disk and reclaims disk space used for distributed parity data.
RAID 6	RAID 5	4 or more	4 or more	Yes	Removes one set of parity data and

Source RAID Level	Target RAID Level	Number of Physical Disks (Beginning)	Number of Physical Disks (End)	Capacity Expansion Possible	Description
					reclaims disk space used for it.
RAID 6	RAID 6	4 or more	5 or more	Yes	Increases capacity by adding disks
RAID 10	RAID 10	Less than 32	32	Yes	Increases capacity by adding disks

 **NOTE:** The total number of physical disks in a disk group cannot exceed 32. You cannot perform RAID level migration and expansion on RAID levels 50 and 60.

Fault tolerance

The PERC 9 series supports the following:

- Self Monitoring and Reporting Technology (SMART)
- Patrol Read
- Physical disk failure detection
- Physical disk rebuild using hot spares
- Controller cache preservation
- Battery and non-volatile cache backup of controller cache to protect data
- Detection of batteries with low charge after boot up

The next sections describe some methods to achieve fault tolerance.

The SMART Feature

The SMART feature monitors certain physical aspects of all motors, heads, and physical disk electronics to help detect predictable physical disk failures. Data on SMART-compliant physical disks can be monitored to identify changes in values and determine whether the values are within threshold limits. Many mechanical and electrical failures display some degradation in performance before failure.

A SMART failure is also referred to as predicted failure. There are numerous factors that are predicted physical disk failures, such as a bearing failure, a broken read/write head, and changes in spin-up rate. In addition, there are factors related to read/write surface failure, such as seek error rate and excessive bad sectors.

 **NOTE:** For detailed information on SCSI interface specifications, see t10.org and for detailed information on SATA interface specifications, see t13.org.

Automatic replace member with predicted failure

A **Replace Member** operation can occur when there is a SMART predictive failure reporting on a physical disk in a virtual disk. The automatic **Replace Member** is initiated when the first SMART error occurs on a physical disk that is part of a virtual disk. The target disk needs to be a hot spare that qualifies as a rebuild

disk. The physical disk with the SMART error is marked as **failed** only after the successful completion of the **Replace Member**. This prevents the array from reaching degraded state.

If an automatic **Replace Member** occurs using a source disk that was originally a hot spare (that was used in a rebuild), and a new disk added for the **Replace Member** operation as the target disk, the hot spare reverts to the hot spare state after a successful **Replace Member** operation.

 **NOTE:** To enable the automatic **Replace Member**, use the Dell OpenManage storage management application. For information on manual **Replace Member**, see [Replacing An Online Physical Disks](#).

Patrol Read

The **Patrol Read** feature is designed as a preventative measure to ensure physical disk health and data integrity. **Patrol Read** scans and resolves potential problems on configured physical disks. The Dell OpenManage storage management application can be used to start **Patrol Read** and change its behavior.

The following is an overview of **Patrol Read** behavior:

- **Patrol Read** runs on all disks on the controller that are configured as part of a virtual disk, including hot spares.
- **Patrol Read** does not run on physical disks that are not part of a virtual disk or are in **Ready** state.
- **Patrol Read** adjusts the amount of controller resources dedicated to **Patrol Read** operations based on outstanding disk I/O. For example, if the system is busy processing I/O operation, then **Patrol Read** uses fewer resources to allow the I/O to take a higher priority.
- **Patrol Read** does not run on any disks involved in any of the following operations:
 - Rebuild
 - Replace Member
 - Full or Background Initialization
 - CC
 - RLM or OCE

 **NOTE:** By default, **Patrol Read** automatically runs every seven days on configured SAS and SATA hard drives. **Patrol Read** is not necessary on SSD and is disabled by default.

For more information on **Patrol Read**, see the Dell OpenManage documentation at dell.com/support/manuals.

Physical disk failure detection

Failed physical disks are detected and rebuilds automatically start to new disks that are inserted into the same slot. Automatic rebuilds can also occur with hot spares. If you have configured hot spares, the controllers automatically try to use them to rebuild failed physical disks.

Using persistent hot spare slots

 **NOTE:** The persistent hot spare slot feature is disabled by default.

The PERC 9 series can be configured so that the system backplane or storage enclosure disk slots are dedicated as hot spare slots. This feature can be enabled using the Dell OpenManage storage management application.

Once enabled, any slots with hot spares configured automatically become persistent hot spare slots. If a hot spare disk fails or is removed, a replacement disk that is inserted into the same slot automatically

becomes a hot spare with the same properties as the one it is replacing. If the replacement disk does not match the disk protocol and technology, it does not become a hot spare.

For more information on persistent hot spares, see the Dell OpenManage documentation at dell.com/support/manuals.

Physical disk hot swapping

 **NOTE:** To check if the backplane supports hot swapping, see the Owner's Manual of your system.

Hot swapping is the manual replacement of a disk while the PERC 9 series cards are online and performing their normal functions. The following requirements must be met before hot swapping a physical disk:

- The system backplane or enclosure must support hot swapping for the PERC 9 series cards to support hot swapping.
- The replacement disk must be of the same protocol and disk technology. For example, only a SAS hard drive can replace a SAS hard drive and only a SATA SSD can replace a SATA SSD.

Using replace member and revertible hot spares

The **Replace Member** functionality allows a previously commissioned hot spare to revert to a usable hot spare. When a disk failure occurs within a virtual disk, an assigned hot spare (dedicated or global) is commissioned and begins rebuilding until the virtual disk is optimal. After the failed disk is replaced (in the same slot) and the rebuild to the hot spare is complete, the controller automatically starts to copy data from the commissioned hot spare to the newly-inserted disk. After the data is copied, the new disk is a part of the virtual disk and the hot spare is reverted to being a ready hot spare. This allows hot spares to remain in specific enclosure slots. While the controller is reverting the hot spare, the virtual disk remains optimal.

 **NOTE:** The controller automatically reverts a hot spare only if the failed disk is replaced with a new disk in the same slot. If the new disk is not placed in the same slot, a manual **Replace Member** operation can be used to revert a previously commissioned hot spare.

 **NOTE:** A **Replace Member** operation typically causes a temporary impact to disk performance. Once the operation completes, performance returns to normal.

Controller cache preservation

The controller is capable of preserving its cache in the event of a system power outage or improper system shutdown. The PERC 9 Series controller is attached to a Battery Backup Unit (BBU) that provides backup power during system power loss to preserve the controller's cache data.

Cache Preservation With NVC

The Non-Volatile Cache (NVC) allows controller cache data to be stored indefinitely. If the controller has data in the cache memory during a power outage or improper system shutdown, a small amount of power from the battery is used to transfer the cache data to a non-volatile flash storage where it remains until power is restored and the system is booted.

Recovering cache data

If a system power loss or improper system shutdown has occurred:

1. Restore the system power.
2. Boot the system.
3. To enter the **BIOS Configuration Utility**, select **Managed Preserved Cache** in the controller menu. For more information, see [Entering the BIOS configuration utility](#).

If there are no virtual disks listed, all preserved cache data has been written to the disk successfully.

Battery Transparent Learn Cycle

A transparent learn cycle is a periodic operation that calculates the charge that is remaining in the battery to ensure there is sufficient energy. The operation runs automatically, and causes no impact to the system or controller performance.

The controller automatically performs the Transparent Learn Cycle (TLC) on the battery to calibrate and gauge its charge capacity once every 90 days. The operation can be performed manually, if required.

 **NOTE:** Virtual disks stay in **Write Back** mode, if enabled, during transparent learn cycle. When the TLC completes, the controller sets the next TLC to +90 days.

TLC time frame

The time frame for completion of a learn cycle is a function of the battery charge capacity and the discharge and charge currents used.

Conditions for replacing the battery

The PERC battery is marked **Failed** when the state or health of the battery is declared bad. If battery is declared failed then the firmware runs learn cycles in subsequent reboots until the battery is replaced. The virtual disk then transitions to **Write Back** mode.

Non-RAID disks support

By default, all the disks are in RAID capable unconfigured state. The user can also convert the RAID capable disks to non-RAID disks using either the BIOS configuration utility or the UEFI/HII RAID configuration utility.

Creating a non-raid disk

To create a non-RAID disk, perform the following steps in the **BIOS Configuration Utility** (<Ctrl> <R>):

1. In the **Virtual Disk Mgmt** screen, use the arrow keys to highlight the PERC 9 adapter or **Disk Group #**.
2. Press <F2>. The list of available action is displayed.
3. Click **Convert to Non-RAID**. The **Convert RAID Capable Disks to Non-RAID** window is displayed.
4. Press the down-arrow key to highlight an available physical disk.
5. Press the spacebar to select the disk.

 **NOTE:** An **X** is displayed beside the selected physical disk(s).

6. Select **OK**.

Deploying the PERC card

 **CAUTION:** Many repairs may only be done by a certified service technician. You should only perform troubleshooting and simple repairs as authorized in your product documentation, or as directed by the online or telephone service and support team. Damage due to servicing that is not authorized by Dell is not covered by your warranty. Read and follow the safety instructions that came with the system.

This document provides a set of high-level installation and removal instructions for the following Dell PowerEdge RAID Controllers (PERC) 9 series:

1. PERC H330 Adapter
2. PERC H330 Mini Monolithic
3. PERC H330 Slim Card
4. PERC H330 Mini Blade
5. PERC H730 Adapter
6. PERC H730 Mini Monolithic
7. PERC H730 Slim Card
8. PERC H730 Mini Blade
9. PERC H730P Adapter
10. PERC H730P Mini Monolithic
11. PERC H730P Slim Card
12. PERC H730P Mini Blade
13. PERC H830 Adapter
14. PERC FD33xS Card
15. PERC FD33xD Card

 **NOTE:** For detailed information on cabling the PERC 9 cards, see the system documentation at dell.com/poweredgemanuals.

Removing the PERC 9 adapter

 **CAUTION:** Many repairs may only be done by a certified service technician. You should only perform troubleshooting and simple repairs as authorized in your product documentation, or as directed by the online or telephone service and support team. Damage due to servicing that is not authorized by Dell is not covered by your warranty. Read and follow the safety instructions that came with the product.

1. Turn off the system, including any attached peripherals, and disconnect the system from the electrical outlet and peripherals.

NOTE: It is recommended that you always use a static mat and static strap while working on components in the interior of the system.

2. Open the system.
3. Locate the PERC card on the system board.

CAUTION: To prevent damage to the card, you must hold the card by its edges only.

4. Lift the card to remove it from the connector on the system board.
5. Disconnect the SAS cables connected to the card:
 - a. Press down and hold the metal tab on the SAS cable connector.
 - b. Pull the SAS cable out of the connector.
6. Replace the storage controller card and connect the cable. For more information on installing the card, see [Installing the PERC 9 adapter](#).
7. Close the system.
8. Reconnect the system to its electrical outlet and turn the system on, including any attached peripherals.

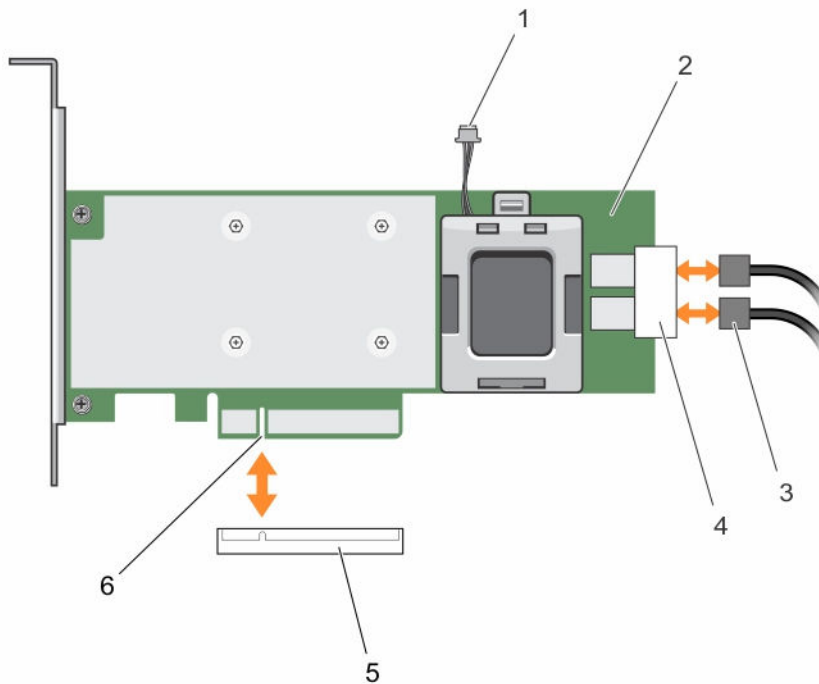



Figure 8. Removing and installing the PERC 9 card

- | | |
|---------------------------------------|-----------------------------|
| 1. battery cable connector | 2. PERC 9 card |
| 3. SAS cables (2) | 4. SAS cable connectors (2) |
| 5. card connector on the system board | 6. PERC card connector |

Installing the PERC 9 adapter

 **CAUTION:** Many repairs may only be done by a certified service technician. You should only perform troubleshooting and simple repairs as authorized in your product documentation, or as directed by the online or telephone service and support team. Damage due to servicing that is not authorized by Dell is not covered by your warranty. Read and follow the safety instructions that came with the product.

1. Turn off the system, including any attached peripherals, and disconnect the system from the electrical outlet.

 **NOTE:** It is recommended that you always use a static mat and static strap while working on components in the interior of the system.

2. Open the system.
3. Align the card-edge connector with the connector on the system board.
To prevent damage to the card, you must hold the card by its edges only.
4. Press the card-edge down until the card is fully seated.
5. Align the PERC card connector with the card connector on the system board and push the PERC card towards the connector to seat it firmly.
6. Connect the SAS data cable connectors to the card.

 **NOTE:** Ensure that you connect the cable according to the connector labels on the cable. The cable does not function properly if reversed.

7. Route the SAS data cable through the clip on the card and through the channel on the inner side of the chassis.
8. Attach the connector labeled "SAS A" to connector SAS A on the backplane, and attach the connector labeled "SAS B" to connector SAS B on the backplane.
9. Close the system.
10. Reconnect the system to its electrical outlet and turn the system on, including any attached peripherals.

Removing the PERC 9 mini monolithic controller

 **CAUTION:** Many repairs may only be done by a certified service technician. You should only perform troubleshooting and simple repairs as authorized in your product documentation, or as directed by the online or telephone service and support team. Damage due to servicing that is not authorized by Dell is not covered by your warranty. Read and follow the safety instructions that came with the product.

1. Turn off the system, including any attached peripherals, and disconnect the system from the electrical outlet and peripherals.

 **NOTE:** It is recommended that you always use a static mat and static strap while working on components in the interior of the system.

2. Open the system.
3. Locate the PERC card on the system board
4. To disconnect the storage controller cable:
 - a. Remove the two screws that secure the cable to the card.

- b. Grasp the cable on both sides of the cable connector, and pull the cable up and away from the PERC card.
5. Angle the card so that the other end of the card disengages from the storage-controller card holder on the system board.
6. Replace the storage controller card and connect the cable. For more information on installing the card, see [Installing the PERC 9 mini monolithic controller](#).
7. Close the system.
8. Reconnect the system to its electrical outlet and turn the system on, including any attached peripherals.

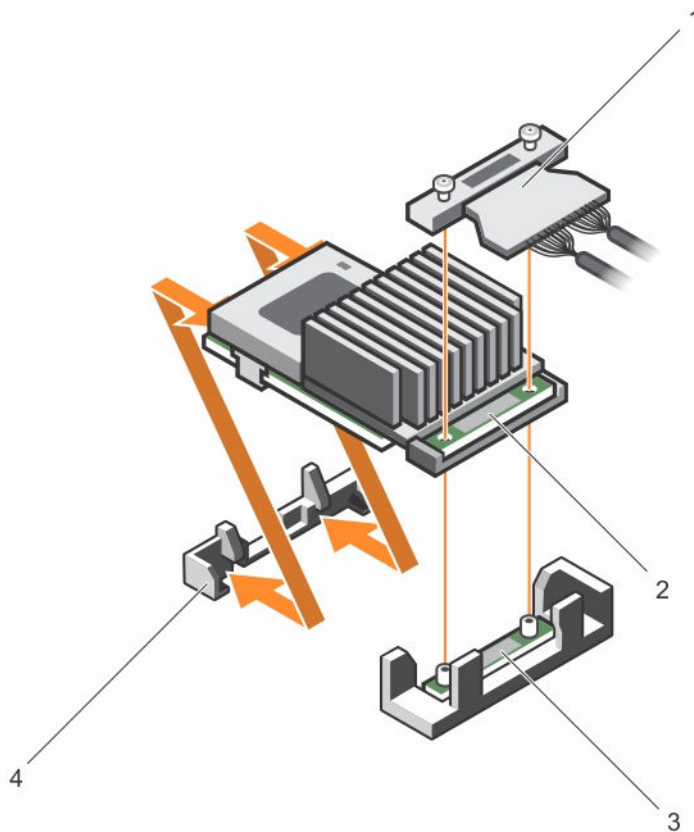



Figure 9. Removing and installing the PERC 9 mini monolithic card

- | | |
|-----------------------------------|--------------------------------------|
| 1. storage controller cable | 2. storage controller card |
| 3. storage-controller card holder | 4. storage controller retention hook |

Replacing the battery of a H730P mini monolithic card

1. Turn off the system, including any attached peripherals, and disconnect the system from the electrical outlet and peripherals.

 **NOTE:** It is recommended that you always use a static mat and static strap while working on components in the interior of the system.

2. Open the system.
3. Locate the PERC card on the system board.
4. Remove the PERC card. For more information, see [Removing the PERC 9 mini monolithic controller](#).
5. Disconnect the battery cable from the PERC card.
6. Pull the battery carrier until the tabs on the battery carrier disengage from the PERC card.

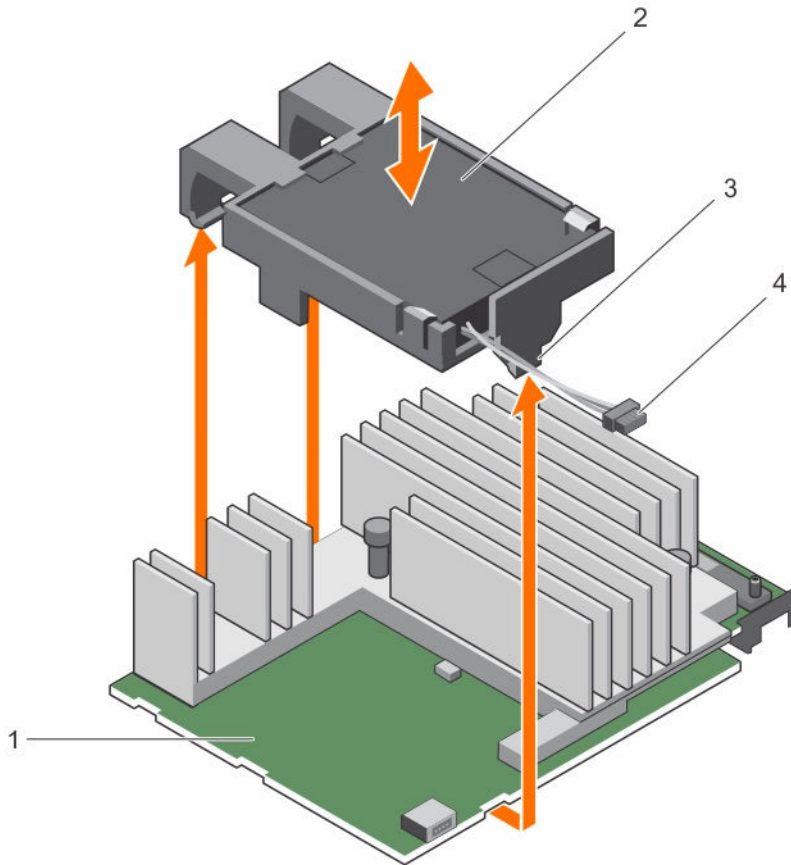

Figure 10. Removing the battery carrier

- | | |
|------------------------------------|------------------|
| 1. PECR H730P mini monolithic card | 2. battery |
| 3. tab on the battery carrier (3) | 4. battery cable |
7. Pull the battery out of the battery carrier.

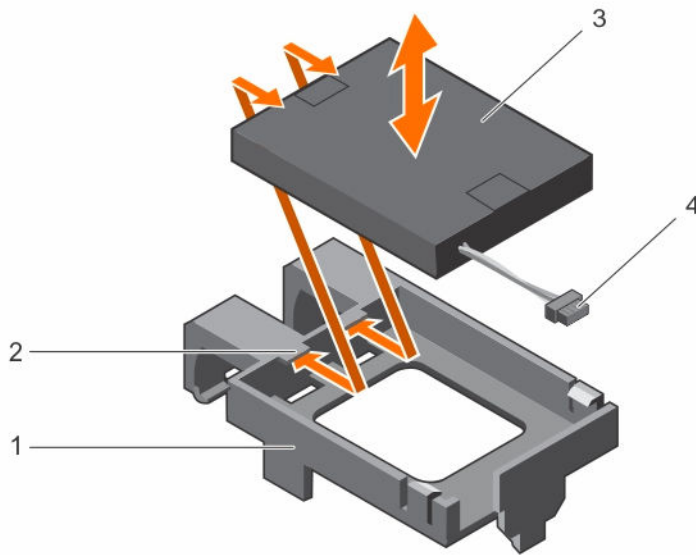

Figure 11. Removing the battery

- | | |
|--------------------|-------------------------------------|
| 1. battery carrier | 2. guide on the battery carrier (2) |
| 3. battery | 4. battery cable |
8. Align the replacement battery with the guides on the battery carrier.
 9. Lower the battery into the carrier until the battery clicks into place.
 10. Align the tabs on the battery carrier with the slots on the PERC9 mini monolithic controller and lower the battery carrier till it clicks into place.
 11. Connect the battery cable to the PERC card.
 12. Replace the PERC card. For more information, see [Installing the PERC 9 mini monolithic controller](#).
 13. Close the system.
 14. Reconnect the system to its electrical outlet and turn on the system, including any attached peripherals.

Installing the PERC 9 mini monolithic controller



⚠ CAUTION: Many repairs may only be done by a certified service technician. You should only perform troubleshooting and simple repairs as authorized in your product documentation, or as directed by the online or telephone service and support team. Damage due to servicing that is not authorized by Dell is not covered by your warranty. Read and follow the safety instructions that came with the product.

1. Turn off the system, including any attached peripherals, and disconnect the system from the electrical outlet.
 - 🔧 NOTE:** It is recommended that you always use a static mat and static strap while working on components in the interior of the system.
2. Open the system.
3. Locate the PERC 9 card connector on the system board and align one end of the card with the card holder on the system board.

⚠ CAUTION: To prevent damage to the card, you must hold the card by its edges only.

4. Lower the other end of the card into the card holder on the system board.
5. Connect the storage controller cable:
 - a. Grasp the cable on both sides of the cable connector and connect to the PERC card.
 - b. Attach the two screws to secure the cable to the card.
6. Connect the SAS data cable connector to the card.
 **NOTE:** Ensure that you connect the cable according to the connector labels on the cable. The cable does not function properly if reversed.
7. Route the SAS data cable through the clip on the card and through the channel on the inner side of the chassis.
8. Attach the connector labeled "SAS A" to connector SAS A on the backplane, and attach the connector labeled "SAS B" to connector SAS B on the backplane.
9. Close the system.
10. Reconnect the system to its electrical outlet and turn the system on, including any attached peripherals.

Removing a H730P slim card

1. Turn off the system, including any attached peripherals, and disconnect the system from the electrical outlet and peripherals.
 **NOTE:** It is recommended that you always use a static mat and static strap while working on components in the interior of the system.
2. Open the system.
3. Locate the H730P slim card on the system board.
4. Loosen the two retention screws on the H730P slim card cable connector.
5. Holding the pull tag, lift the H730P slim card cable connector from the system board connector.
6. Press the release latch on the side of the chassis to the unlock position and slide the H730P slim card toward the back of the system.
 **CAUTION:** To prevent damage to the H730P slim card, you must hold the card only by its edges.
7. Lift the card up and away from the system.
8. Replace the storage controller card and connect the cable. For more information on installing the card, see [Installing a H730P Slim card](#).

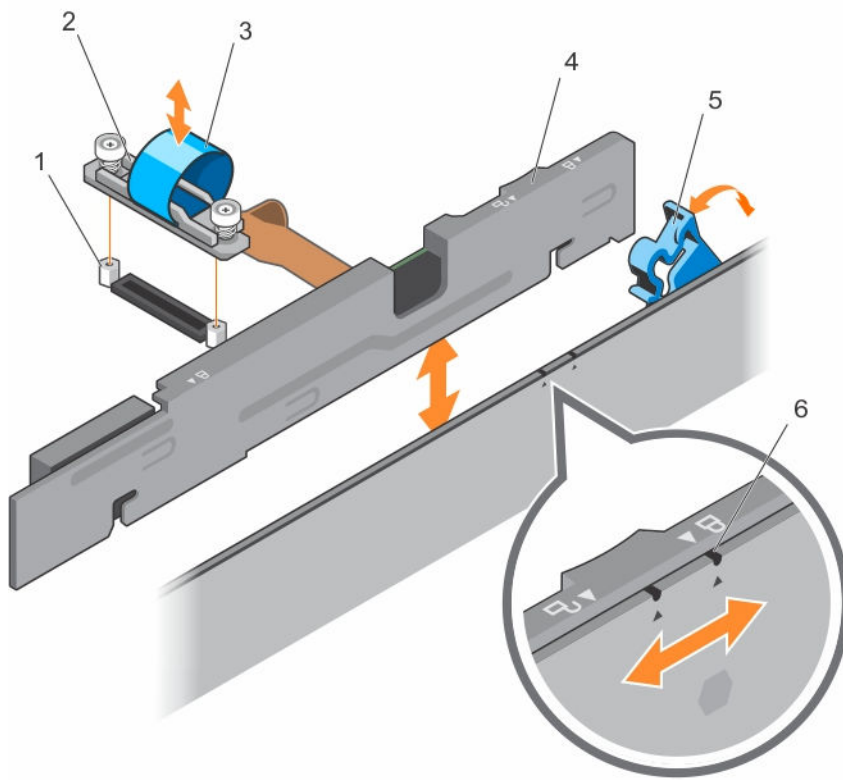



Figure 12. Removing and installing a H730P slim card

- | | |
|----------------------------------|--|
| 1. standoff (2) | 2. H730P slim card cable connector |
| 3. pull tag | 4. H730P slim card |
| 5. H730P slim card release latch | 6. lock and unlock icon on the H730P slim card bracket |

Replacing the battery of a H730P slim card

The battery attached to the H730P slim card can be replaced.

1. Turn off the system, including any attached peripherals, and disconnect the system from the electrical outlet and peripherals.
 -  **NOTE:** It is recommended that you always use a static mat and static strap while working on components in the interior of the system.
2. Open the system.
3. Locate the H730P slim card on the system board.
4. Remove the H730P slim card. For more information, see [Removing a H730P Slim card](#).
5. Remove the screw that secures the battery along with the flexible cable retainer to the H730P slim card.
6. Remove the clamp that secures the battery along with the flexible cable retainer to the H730P slim card.
7. Pull the blue tab to an upright position, until the top of the battery is out of the battery holder on the H730P slim card.

8. Disconnect the battery cable from the H730P slim card.
9. Lift the battery out of the battery holder.

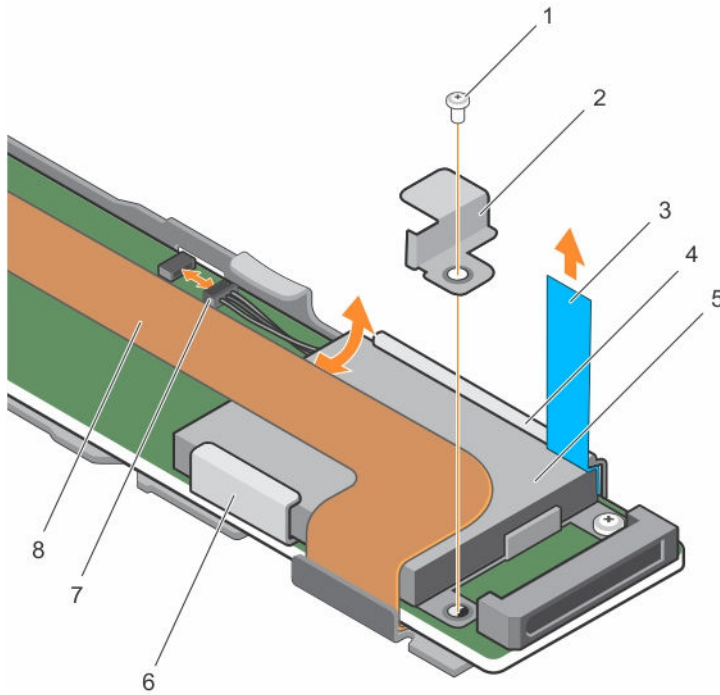



Figure 13. Removing the battery

- | | |
|--|--|
| 1. screw securing the battery to the H730P slim card | 2. clamp securing the battery to the H730P slim card |
| 3. tab | 4. H730P slim card |
| 5. battery | 6. battery holder |
| 7. battery cable | 8. flexible cable retainer |
10. Insert the battery into the battery holder.
 11. Push the blue tab toward the inserted battery.
 12. Attach the clamp that secures the battery along with the flexible cable retainer to the H730P slim card.
 13. Attach the screw that secures the battery along with the flexible cable retainer to the H730P slim card.
 14. Connect the battery cable to the H730P slim card.
 15. Replace the H730P slim card. For more information, see [Installing a H730P Slim card](#).
 16. Close the system.
 17. Reconnect the system to its electrical outlet and turn on the system, including any attached peripherals.

Installing a H730P slim card

1. Turn off the system, including any attached peripherals, and disconnect the system from the electrical outlet.

 **NOTE:** It is recommended that you always use a static mat and static strap while working on components in the interior of the system.

2. Open the system.
3. Press the release latch on the side of the chassis to the unlock position.
4. Align the slots on the H730P slim card with the standoffs on the side of the chassis.

 **CAUTION:** To prevent damage to the system memory, ensure that the H730P slim card does not come in contact with the memory modules during installation

5. Lower the H730P slim card into the chassis until the slots on the card engage with the standoffs on the side of the chassis.
6. Press the release latch to the lock position to secure the card firmly on the chassis.
The H730P slim card connects to the backplane connector.
7. Hold the pull tag on the H730P slim card cable connector and route the cable between the memory-module ejectors.
8. Align the retention screws on the H730P slim card cable connector with the screw holes on the system board connector.
9. Tighten the two retention screws to secure the H730P slim card cable connector on the system board.

Removing the PERC 9 mini blade controller

1. Turn off the system, including any attached peripherals, and disconnect the system from the electrical outlet and peripherals.

 **NOTE:** It is recommended that you always use a static mat and static strap while working on components in the interior of the system.

2. Open the system.
3. Locate the PERC card on the system board.
4. Loosen the two retention screws on the hard-drive/SSD backplane cable connector and lift it away from the PERC 9 mini blade controller.

 **CAUTION:** To prevent damage to the PERC 9 mini blade controller, you must hold the card by its edges only.

5. Lift the PERC 9 mini blade controller up and out of the connector.
6. Replace the storage controller card and connect the cable. For more information on installing the card, see [Installing the PERC 9 mini blade controller](#).
7. Close the system.
8. Reconnect the system to its electrical outlet and turn the system on, including any attached peripherals.

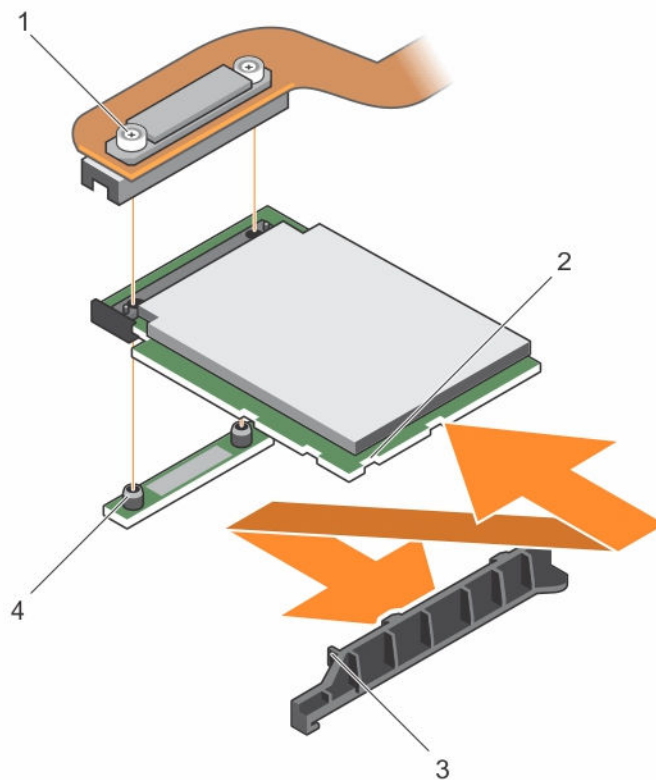

Figure 14. Removing and installing the PERC 9 mini blade controller

- | | |
|--|--|
| 1. hard-drive/SSD backplane cable connector | 2. slot on the PCIe extender/storage controller card |
| 3. tabs on the PCIe extender/storage controller card support bracket | 4. standoff (2) |

Replacing the tethered battery of a PERC 9 mini blade card

The tethered battery attached to the PERC 9 mini blade card can be replaced. This tethered battery feature is applicable only to the PowerEdge FC630 and FC830 systems.

1. Turn off the system, including any attached peripherals, and disconnect the system from the electrical outlet and peripherals.

NOTE: It is recommended that you always use a static mat and static strap while working on components in the interior of the system.

2. Open the system.
3. Locate the battery carrier of the PERC card on the system board.
4. Push the tab on the battery carrier forward until the battery carrier disengages from the slot of the chassis.

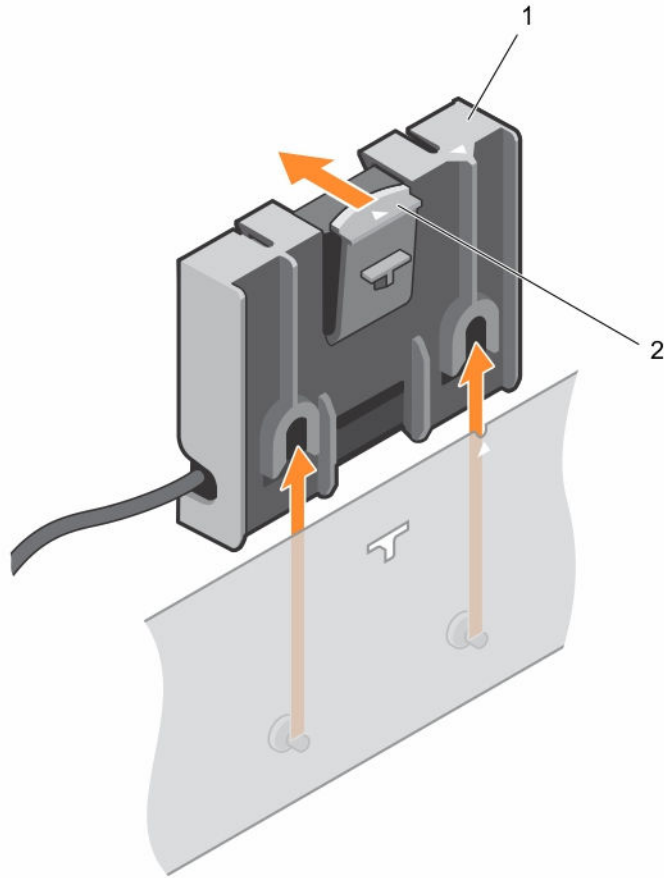

Figure 15. Removing the battery carrier

1. tab on the battery carrier
2. battery carrier of the tethered battery
5. Disconnect the battery cable connector from the connector on the mini blade and lift the battery carrier away from the system.
6. Pull the battery out of the battery carrier.

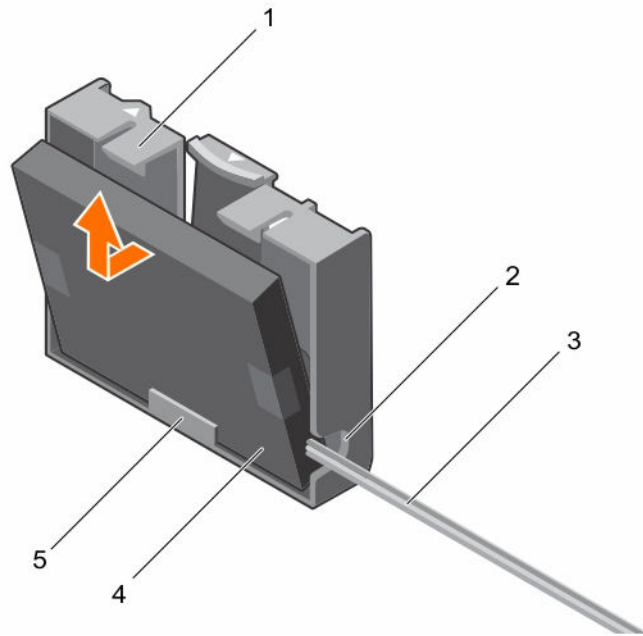

Figure 16. Removing the battery from the battery carrier

1. battery carrier
 2. slot on the tethered battery carrier
 3. tethered battery cable
 4. battery
 5. guide for the battery on the battery carrier
7. Align the lower end of the replacement battery into the battery carrier and push the battery towards the carrier until it clicks into place.

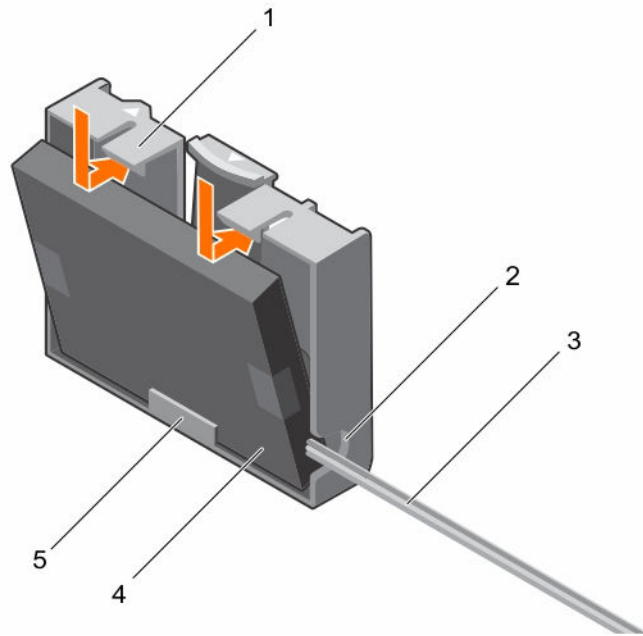

Figure 17. Installing the battery into the battery carrier

1. battery carrier
 2. slot for the tethered battery carrier
 3. tethered battery cable
 4. battery
 5. guide for the battery on the battery carrier
- 8.** Align the battery carrier with the guide pin slots on the chassis and lower the battery carrier until the guide pin slots on the battery carrier engage with the guide pins on the chassis

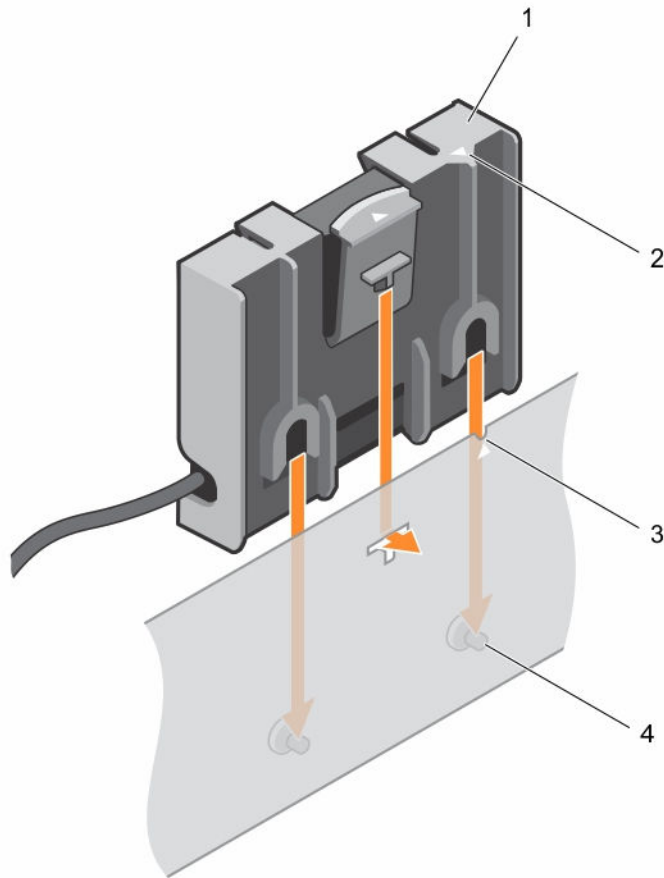



Figure 18. Replacing the battery carrier

- | | |
|------------------------------|-------------------------------|
| 1. battery carrier | 2. tab on the battery carrier |
| 3. guide slot on the chassis | 4. guide pins on the chassis |

9. Connect the battery cable to PERC 9 mini blade controller.
10. Close the system.
11. Reconnect the system to its electrical outlet and turn on the system, including any attached peripherals.

Installing the PERC 9 mini blade controller

1. Turn off the system, including any attached peripherals, and disconnect the system from the electrical outlet.
 -  **NOTE:** It is recommended that you always use a static mat and static strap while working on components in the interior of the system.
2. Open the system.
3. Remove the NDC riser.
4. Lift the clamp attached to the power supply bay and locate the PERC 9 card connector on the system board.

 **CAUTION: To prevent damage to the card, you must hold the card by its edges only.**

5. Align the following:
 - a. screw holes on the PERC 9 mini blade controller with the standoffs on the system board connector.
 - b. slots on the PERC 9 mini blade controller edge with the tabs on the support bracket.
6. Lower the PERC 9 mini blade controller onto the connector on the system board.
7. Tighten the two retention screws on the hard-drive/SSD backplane cable connector to secure the card on to the system board.
8. Install the tethered battery cable, if applicable.
9. Close the clamp.
10. Install the NDC riser.
11. Close the system.
12. Reconnect the system to its electrical outlet and turn the system on, including any attached peripherals.

Removing the PERC FD33xD Card

 **CAUTION: Many repairs may only be done by a certified service technician. You should only perform troubleshooting and simple repairs as authorized in your product documentation, or as directed by the online or telephone service and support team. Damage due to servicing that is not authorized by Dell is not covered by your warranty. Read and follow the safety instructions that came with the product.**

 **NOTE:** PERC FD33xS and FD33xD cards are supported only on PowerEdge FD332 system. The procedure for removing a PERC FD33xS card is identical to removing a PERC FD33xD card.

1. Turn off the system, including any attached peripherals, and disconnect the system from the electrical outlet and peripherals.
 -  **NOTE:** It is recommended that you always use a static mat and static strap while working on components in the interior of the system.
2. Open the system.
3. Locate the PERC card.
4. Loosen the screws securing the cable to the PERC card.
5. Lift the cable away from the PERC card by holding the cable touch point.
6. Holding the touch point, allow the cable to slowly retract into the cable coil.
7. Remove the screws securing the PERC card to the PERC card holder.
8. Holding it by the touch points, lift the PERC card from the connector on the midplane interface module.

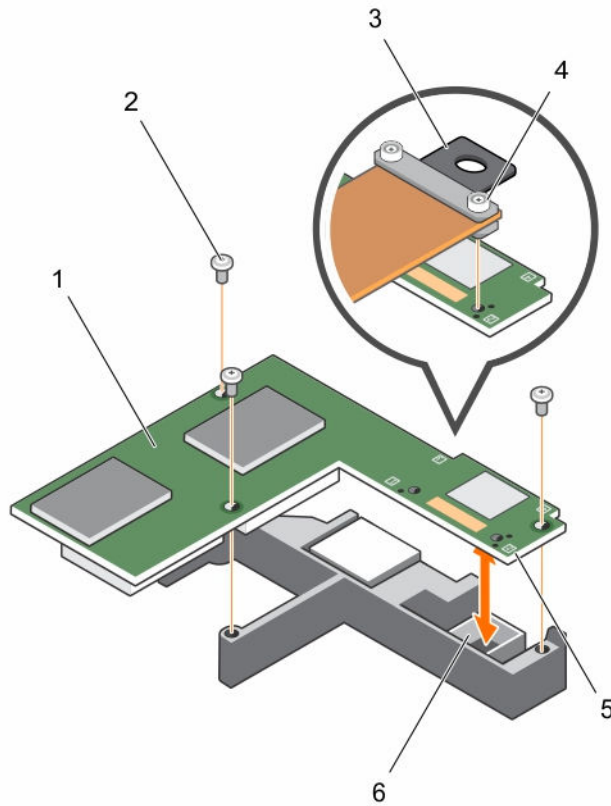

Figure 19. Removing and installing the PERC FD33xD card

- | | |
|-------------------------------------|---|
| 1. PERC FD33xD card | 2. screw (3) |
| 3. touch point on the cable | 4. cable screw (2) |
| 5. touch point on the PERC card (4) | 6. connector on midplane interface module |

9. Close the system.
10. Reconnect the system to its electrical outlet and turn on the system, including any attached peripherals.

Replacing the battery of a PERC FD33xD card

NOTE: The procedure for replacing the battery of a PERC FD33xS card is identical to replacing the battery of a PERC FD33xD card.

1. Turn off the system, including any attached peripherals, and disconnect the system from the electrical outlet and peripherals.

NOTE: It is recommended that you always use a static mat and static strap while working on components in the interior of the system.

2. Open the system.
3. Locate the PERC card.
4. Remove the PERC card. For more information, see [Removing the PERC FD33xD Card](#).
5. Disconnect the battery cables from the PERC card.

6. Slide the battery carrier in the direction of the arrow printed on the battery carrier, and then flip the battery carrier open.
7. Remove the battery from the PERC card.

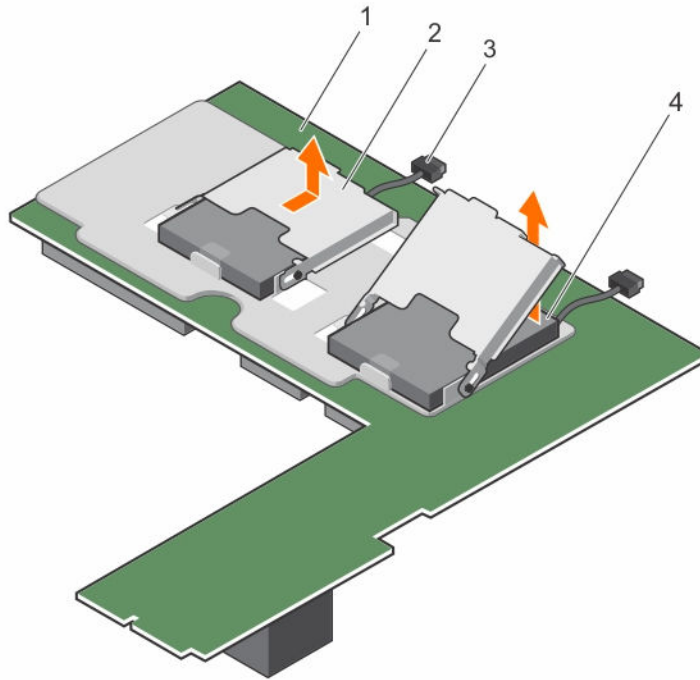

Figure 20. Removing the battery

- | | |
|---------------------|--------------------|
| 1. PERC FD33xD card | 2. battery carrier |
| 3. battery cable | 4. battery |

8. Install the replacement battery on the controller.
9. Push the battery carrier toward the battery and slide the battery carrier till it clicks into place.
10. Connect the battery cables to the PERC card.
11. Replace the PERC card. For more information, see [Installing the PERC FD33xD card](#).
12. Close the system.
13. Reconnect the system to its electrical outlet and turn on the system, including any attached peripherals.

Installing the PERC FD33xD card

CAUTION: Many repairs may only be done by a certified service technician. You should only perform troubleshooting and simple repairs as authorized in your product documentation, or as directed by the online or telephone service and support team. Damage due to servicing that is not authorized by Dell is not covered by your warranty. Read and follow the safety instructions that came with the product.

NOTE: PERC FD33xS and FD33xD cards are supported only on PowerEdge FD332 system. The procedure for installing a PERC FD33xS card is identical to installing a PERC FD33xD card.

1. Turn off the system, including any attached peripherals, and disconnect the system from the electrical outlet.



NOTE: It is recommended that you always use a static mat and static strap while working on components in the interior of the system.

2. Open the system.
3. Align the PERC card with the connector on the midplane interface module.
4. Lower the PERC card until it is firmly seated on the connector on the midplane interface module.
5. Install the screws to secure the PERC card to the PERC card holder on the midplane interface module.
6. Holding the cable touch point, align the cable guide pins with the holes on the PERC card.
7. Tighten the screws to secure the cable to the PERC card.
8. Close the system.
9. Reconnect the system to its electrical outlet and turn on the system, including any attached peripherals.

Driver installation

The Dell PowerEdge RAID Controller (PERC) 9 series of cards require software drivers to operate with the supported operating systems.

This chapter contains the procedures for installing the drivers for the PERC 9 cards.

 **NOTE:** The drivers for PERC 9 for VMware ESXi is packaged within the VMware ESXi ISO image downloaded from Dell. For more information, see the VMware documentation at dell.com/virtualizationsolutions. It is not recommended to have drivers from controllers prior to PERC 9 on the same system.

The two methods for installing a driver discussed in this chapter are:

- **Installing a driver during operating system installation:** Use this method if you are performing a new installation of the operating system and want to include the drivers.
- **Updating existing drivers:** Use this method if the operating system and the PERC 9 family of controllers are already installed and you want to update to the latest drivers.

 **NOTE:** It is recommended that you update existing operating system drivers after installation. Native driver support is available for Windows 2012 R2.

Creating the device driver media

Use one of the following two methods to create the device driver media:

- [Downloading Drivers From The Dell Systems Service And Diagnostic Tools Media](#)
- [Downloading Drivers From The Dell Support Website](#)

Downloading drivers from the Dell support website

To download drivers from the Dell Support website:

1. Go to dell.com/support.
2. Enter the service tag of your system in the **Choose by Service Tag to get started** field or select **Choose from a list of all Dell products**.
3. Select the **System Type**, **Operating System**, and **Category** from the drop-down list.
The drivers that are applicable to your selection are displayed.
4. Download the drivers that you require to a USB drive, CD, or DVD.
5. During the operating system installation, use the media that you created with the **Load Driver** option to load mass storage drivers. For more information on reinstalling the operating system, see the relevant section for your operating system below.

Downloading drivers from the Dell systems service and diagnostic tools media

To download drivers from the *Dell Systems Service and Diagnostic Tools* media:

1. Insert the *Dell Systems Service and Diagnostic Tools* media in your system.
The **Welcome to Dell Service and Diagnostic Utilities** screen is displayed.
2. Select your system model and operating system.
3. Click **Continue**.
4. From the list of drivers displayed, select the driver you require.
5. Select the self-extracting zip file and click **Run**.
6. Copy the driver to a CD, DVD, or USB drive.
7. Repeat this procedure for all the drivers you require.

Windows driver installation

Before you install the Windows driver for PERC 9, you must first create a device driver media.

- Read the Microsoft *Getting Started* document that shipped with your operating system.
- Ensure that your system has the latest BIOS, firmware, and driver updates. If required, download the latest BIOS, firmware, and driver updates from **dell.com/support**.
- Create a device driver media using one of the methods listed below:
 - USB drive
 - CD
 - DVD

Installing the driver during a Windows Server 2008 R2 and newer installation

To install the driver:

1. Boot the system using the Windows Server 2008 R2, or newer media.
2. Follow the on-screen instructions until you reach **Where do you want to install Windows Server 2008 R2 or newer** window and then select **Load driver**.
3. The system prompts you to insert the media. Insert the installation media and browse to the appropriate location.
4. Select a PERC 9 series card from the list.
5. Click **Next** and continue installation.

Installing the driver after Windows Server 2008 R2 and newer installation

Perform the following steps to configure the driver for the RAID controller on a system that already has Windows installed:

1. Turn off the system.
2. Install the new RAID controller in the system.
For detailed instructions on installing the RAID controller in the system, see [Deploying the PERC card](#).
3. Turn on the system.
The **Found New Hardware Wizard** screen displays the detected hardware device.

4. Click **Next**.
5. On the **Locate device driver** screen, select **Search for a suitable driver for my device** and click **Next**.
6. Browse and select the drivers from the **Locate Driver Files** screen.
7. Click **Next**.
The wizard detects and installs the appropriate device drivers for the new RAID controller.
8. Click **Finish** to complete the installation.
9. Reboot the system when prompted.

Updating PERC 9 driver for existing Windows Server 2008 R2 and newer

 **NOTE:** Close all applications on your system before you update the driver.

1. Insert the media (CD, DVD, or USB drive) containing the driver.
2. Select **Start** → **Settings** → **Control Panel** → **System**.
The **System Properties** screen is displayed.

 **NOTE:** The path to **System** might vary depending on the operating system family.

3. Click on the **Hardware** tab.
4. Click **Device Manager**.
The **Device Manager** screen is displayed.

 **NOTE:** The path to **Device Manager** might vary depending on the operating system family.

5. Expand **SCSI and RAID Controllers** by double-clicking the entry or by clicking on the plus symbol next to **SCSI and RAID Controller**.

 **NOTE:** In Windows Server 2008, Windows Server 2008 R2, and Windows Server 2012, the PERC 9 series of cards are listed under **Storage Controllers**.

6. Double-click the RAID controller for which you want to update the driver.
7. Click the **Driver** tab and click **Update Driver**.
The screen to update the device driver wizard is displayed.
8. Select **Install from a list or specific location**.
9. Click **Next**.
10. Follow the steps in the wizard and browse to the location of the driver files.
11. Select the INF file from the driver media (CD, DVD, or other media).
12. Click **Next** and continue the installation steps in the wizard.
13. Click **Finish** to exit the wizard and reboot the system for the changes to take place.

 **NOTE:** Dell provides the Dell Update Package (DUP) to update drivers on systems running Windows Server 2008 R2 and newer operating system. DUP is an executable application that updates drivers for specific devices. DUP supports command line interface and silent execution. For more information, see dell.com/support.

Linux driver installation

 **NOTE:** PERC 9 series of drivers support PERC 5, PERC 6, PERC 7, and PERC 8 family controllers and do not require separate driver installations.

-  **NOTE:** The driver update disk (DUD) images are created only for those operating system releases in which the native (in-box) driver is insufficient for installation. In the event that an operating system is being installed with a corresponding DUD image, follow the instructions below.

Installing or updating the RPM driver package with KMOD support

-  **NOTE:** This procedure is applicable for Red Hat Enterprise Linux 6.5 SP2.

Perform the following steps to install the RPM package with KMOD support:

1. Uncompress the gzipped tarball driver release package.
2. Install the driver package using the command: `rpm -ihv kmodmegaraid_ sas-<version>.rpm`.

-  **NOTE:** Use `rpm -Uvh <package name>` when upgrading an existing package.

3. If the previous device driver is in use, you must reboot the system for the updated driver to take effect.
4. Verify that the driver is loaded with the following system commands: `modinfo megaraid_sas`.

Installing or updating the RPM driver package with KMP support

-  **NOTE:** This procedure is applicable for SUSE Enterprise Linux 11 SP2.

Perform the following steps to install the RPM package with KMP support:

1. Uncompress the gzipped tarball driver release package.
2. Install the driver package using the command: `rpm -ihv kmpmegaraid_ sas- <version>.rpm`.

-  **NOTE:** Use `rpm -Uvh <package name>` when updating an existing package.

3. If the previous device driver is in use, you must reboot the system for the updated driver to take effect.
4. Verify that the driver is loaded with the following system commands: `modinfo megaraid_sas`.

BIOS Configuration Utility

The **BIOS Configuration Utility**, (Ctrl R), is a storage management application embedded on the PERC 9 cards that configure and maintain RAID disk groups and virtual disks. Ctrl R is independent of the operating system.

 **NOTE:** Use the **BIOS Configuration Utility** (Ctrl R) for initial setup and disaster recovery. You can use advanced features through Dell OpenManage storage management application and Dell SAS RAID storage manager.

The following sections provide information about using the **BIOS Configuration Utility** (Ctrl R). For more information, see the online help option by pressing F1 in the **BIOS Configuration Utility** (Ctrl R).

 **NOTE:** The PERC 9 card configuration utility refreshes the screen every 15 seconds to show changes to the information. You can also press F5 to refresh the screen.

Entering the BIOS Configuration Utility

Perform the following steps to enter the **BIOS Configuration Utility** (<Ctrl> <R>) when you boot the system:

1. Turn on the system.
A BIOS screen displays information about the controller and configuration.
2. During startup, press <Ctrl> <R> when prompted by the BIOS screen.
3. Use the arrow keys to select the RAID controller you want to configure, and press <Enter> to access the management menus for the controller.
If there is only one controller, the **Virtual Disk Management** screen for that controller is displayed. If there is more than one controller, the main menu screen is displayed. The screen lists the RAID controllers.

 **NOTE:** You can access multiple controllers through the **BIOS Configuration Utility** (<Ctrl> <R>) by pressing <F12>.

Exiting the Configuration Utility

To exit the **BIOS Configuration Utility** (<Ctrl> <R>)

1. Press <Esc> on any menu screen.
If there is only one controller, then a dialog box is displayed to confirm your choice.
2. Select **OK** to exit and press <Enter>.
If multiple controllers are present, then the <Esc> key brings you to the **Controller Selection** screen.
3. Press <Esc> again to reach the exit screen.

A dialog box is displayed to confirm your choice.

4. Select **OK** to exit and press <Enter>.

Menu navigation controls

The following table displays the menu keys you can use to move between the different screens in the **BIOS Configuration Utility** (<Ctrl> <R>).

Table 8. Menu navigation keys

Notation	Meaning and Use	Example
right-arrow key	Use the right-arrow key to open a submenu, move from a menu heading to the first submenu, or move to the first item in that submenu. If you press the right-arrow key at a menu heading, the submenu expands. Press it again to go to the first item in the submenu. The right-arrow key is also used to close a menu list in a popup window. Word wrap is supported.	Start → Programs
left-arrow key	Use the left-arrow key to close a submenu, move from a menu item to the menu heading for that item, or move from a submenu to a higher level menu. If you press the left-arrow key at a menu heading, the submenu collapses. Press it again to go to the higher-level menu. Word wrap is supported.	Controller 0 ← Disk Group 1
up-arrow key	Use the up-arrow key to move to the upper menu items within a menu or to a higher level menu. You can also use the up-arrow key to close a menu list in a popup window, such as the stripe element size menu. Word wrap is supported.	Virtual Disk 1 ↑ Virtual Disk 4
down-arrow key	Use the down-arrow key to move to the lower menu items within a menu or to a lower level menu. You can also use the down-arrow key to open a menu list in a popup window, such as the stripe element size menu, and select a setting. Word wrap is supported.	Virtual Disk 1 ↓ Virtual Disk 4
<Enter>	After you highlight a menu item, press <Enter> to select that item. An options menu for the menu item opens. It applies to only certain menu items, such as Virtual Disk # . In a list of options for that item, such as the write policy for a virtual disk, highlight a setting, such as Write-Through , and press <Enter> to select it.	Select Add New VD and press <Enter> to create a new virtual disk.
<Esc>	After you expand a pop-up window, press <Esc> to close the window. You can continue to press <Esc> to exit the BIOS Configuration Utility (<Ctrl> <R>).	Press <Esc> to return to the VD Mgmt screen.

Notation	Meaning and Use	Example
<Tab>	Press <Tab> to move the cursor to the next control on a dialog box or page.	Press <Tab> to move the cursor to the next parameter you want to change.
<Shift> <Tab>	Press <Shift> <Tab> to move the cursor to the previous control on a dialog or page.	Press <Shift> <Tab> to move the cursor from Sort By to the previously selected PD in the PD Mgmt screen.
<Ctrl> <N>	Press <Ctrl> <N> to move to the next menu screen among the main menu screens: VD Mgmt, PD Mgmt, Ctrl Mgmt, and Foreign View.	Press <Ctrl> <N> on the VD Mgmt screen to move to the PD Mgmt screen.
<Ctrl> <P>	Press <Ctrl> <P> to move to the previous menu screen among the main menu screens: VD Mgmt, PD Mgmt, Ctrl Mgmt, and Foreign View.	Press <Ctrl> <P> on the PD Mgmt screen to move to the VD Mgmt screen.
<F1>	Press <F1> to access Help information. The Help screens display a glossary of topics you can use to access information about navigation, RAID levels, and general topics.	<F1>
<F2>	Press <F2> to access the context menu, which displays the list of options.	<F2>
<F5>	Press <F5> to refresh the information on the screen.	<F5>
<F11>	Switch between two controllers.	<F11>
<F12>	Press <F12> to display a list of controllers.	<F12>
Spacebar	Press the <spacebar> to select an item.	Press the <spacebar> to select or deselect a controller setting in the Ctrl Mgmt View.

Setting up virtual disks

You can set up a disk group and create virtual disks using the procedures in this section. Each procedure is explained individually in this section in detail.

To set up virtual disks:

1. Create virtual disks. See [Creating virtual disks](#).
2. Select the virtual disk options.
3. Designate hot spares (optional).
For more information, see [Managing dedicated hot spares](#).
4. Initialize the virtual disks.



NOTE: When you use one physical disk group to create multiple virtual disks, all the virtual disks must be configured with the same RAID level.

When you define the virtual disks, you can set the following virtual disk parameters:



- RAID level
- Stripe element size
- Read policy

- Write policy
- Type of initialization
- Hot spare configuration

 **NOTE:** The default hard drive cache policy for a virtual disk with SAS hard drives is disabled and virtual disk with SATA hard drives is enabled. The Virtual Disk parameter cannot be changed in the **BIOS Configuration Utility** (<Ctrl> <R>). Use Dell OpenManage Storage Management for the hard drive cache setting operation.

The following table shows the parameters that you can configure when defining virtual disks.

Table 9. Parameters — description

Parameter	Description
RAID Level	Specifies whether the virtual disk is RAID 0, 1, 5, 6, 10, 50, or 60. The number of disks, disk capacity, requirements for fault tolerance, performance, and capacity should be considered when selecting the RAID level.
Stripe Element Size	<p>Specifies the size of the segments written to each physical disk in a RAID 0, 1, 5, 6, 10, 50, and 60 virtual disk. You can set the stripe element size to 64 KB, 128 KB, 256 KB, 512 KB, or 1 MB. The default and recommended stripe element size is 64 KB.</p> <p>A larger stripe element size provides better read performance if your system mostly does sequential reads.</p>
Write Policy	<p>Specifies the controller write policy. You can set the write policy to Write-Back or Write-Through.</p> <p>In Write-Back caching, the controller sends a data transfer completion signal to the host when the controller cache has received all the data in a transaction.</p> <p> NOTE: If a Battery Backup Unit (BBU) is present, the default cache setting is Write-Back. If no BBU is present, the default cache policy default setting is Write-Through.</p> <p> NOTE: If Write-Back is enabled and the system is turned off and then on, the controller may pause as the system flushes cache memory. Controllers have a battery backup default to Write-Back caching. In Write-Through caching, the controller sends a data transfer completion signal to the host when the disk subsystem has received all the data in a transaction.</p>
Read Policy	<p>Read-Ahead enables the read-ahead feature for the virtual disk. You can set the parameter to Read-Ahead or No-Read-Ahead. The default is Read-Ahead.</p> <p>Read-Ahead specifies that the controller uses Read-Ahead for the current virtual disk. Read-Ahead capability allows the controller to read sequentially ahead of requested data and store the additional data in the cache memory, anticipating that the data is required soon.</p> <p>No-Read-Ahead specifies that the controller does not use read ahead for the current virtual disk.</p>

BIOS Configuration Utility menu options

The first menu that is displayed when you access the **BIOS Configuration Utility** <Ctrl> <R> is the main menu screen. It lists the controller, controller number, and other information, such as the slot number. On the screen, you can use the arrow keys to select the RAID controller you want to configure. Press <Enter> to access the controller

This section describes the options for the **BIOS Configuration Utility** (<Ctrl> <R>) for each of the major menus:

- **Virtual Disk Management (VD Mgmt)** menu
- **Physical Disk Management (PD Mgmt)** menu
- **Controller Management (Ctrl Mgmt)** menu
- **Foreign Configuration View (Foreign View)** menu

Most menus consist of two panels:

- A left panel with the menu options
- A right panel with details of the items selected in the left panel

The following sections describe the menu and submenu options for each of the major menus:

Virtual disk management

The Virtual Disk Management screen, **VD Mgmt** is the first screen that is displayed when you access a RAID controller from the main menu screen on the **BIOS Configuration Utility** (<Ctrl> <R>). The left panel displays the menus for the virtual disk management as given below:

Controller—Consists of the sub-menu item **Disk Group** which again has the following sub-menu items:

- **Virtual Disks**
- **Physical Disks**
- **Total Free Capacity** (virtual disk size and free space you can use to create a virtual disk)
- **Hot Spares** (global and dedicated)

The right panel displays detailed information for the selected controllers, disk groups, virtual disks, physical disks, total free capacity, and hot spares, as shown in the following table:

Table 10. Information on the virtual disk management screen

Menu Item Selected in Left Panel	Information Displayed in Right Panel
Controller	Controller Properties: <ul style="list-style-type: none">• Number of disk groups (DG)• Number of virtual disks (VD)• Number of physical disks (PD)
Disk Group #	Disk Group # Properties: <ul style="list-style-type: none">• Number of virtual disks (VD)• Number of physical disks (PD)• Space available on the physical disks

Menu Item Selected in Left Panel	Information Displayed in Right Panel
Virtual Disks	<ul style="list-style-type: none"> • Number of free segments • Number of dedicated hot spares • Security property of the Disk Group <p>Disk Group # Properties:</p> <ul style="list-style-type: none"> • Number of virtual disks (VD) • Number of physical disks (PD) • Space available in the virtual disk • Number of free segments • Number of dedicated hot spares
Virtual Disk #	<p>Virtual Disk # Properties:</p> <ul style="list-style-type: none"> • RAID level (0, 1, 5, 6, 10, 50, or 60) • RAID status of the virtual disk (Failed, Degraded, Partially Degraded, or Optimal) • Operation currently in progress <p>Disk Group # Properties:</p> <ul style="list-style-type: none"> • Number of virtual disks (VD) • Number of physical disks (PD) • Space available on the physical disks • Number of free segments • Number of dedicated hot spares
Physical Disks	<p>Disk Group # Properties:</p> <ul style="list-style-type: none"> • Number of virtual disks (VD) • Number of physical disks (PD) • Space available on the physical disks • Number of free segments • Number of dedicated hot spares
Physical Disk #	<p>Physical Disk Properties:</p> <ul style="list-style-type: none"> • Vendor name • Physical disk state • Enclosure Position • Slot Position <p>Disk Group # Properties:</p> <ul style="list-style-type: none"> • Number of virtual disks (VD) • Number of physical disks (PD) • Space available on the physical disks • Number of free segments • Number of dedicated hot spares
Total Free Capacity	<p>Disk Group # Properties:</p> <ul style="list-style-type: none"> • Number of virtual disks (VD) • Number of physical disks (PD)

Menu Item Selected in Left Panel	Information Displayed in Right Panel
	<ul style="list-style-type: none"> • Space available on the physical disks • Number of free segments • Number of dedicated hot spares
Hot Spares	Physical Disk Properties: <ul style="list-style-type: none"> • Vendor name • Physical disk state • Enclosure Position • Slot Position Disk Group # Properties: <ul style="list-style-type: none"> • Number of virtual disks (VD) • Number of physical disks (PD) • Space available on the physical disks • Number of free segments • Number of dedicated hot spares

Virtual disk actions

The following table describes the actions you can perform on virtual disks. For detailed information on each action below, see [Virtual Disk Management](#).

Table 11. Virtual disk actions

Action	Description
Create a new virtual disk	Creates a new virtual disk from one or more physical disks. You can configure hot spares when you create a virtual disk.
Manage dedicated hot spares	Creates or deletes a hot spare, which is dedicated to a single redundant virtual disk.
Initialize a virtual disk	Initializes the selected virtual disk. You must initialize every virtual disk that is configured. You can perform a fast initialization or a full initialization.
Check data consistency on a virtual disk	Verifies the correctness of the redundancy data in the selected virtual disk. The option is available only if RAID level 1, 5, 6, 10, 50, or 60 is used. The PERC 9 series of cards automatically correct any differences found in the data.
Display or update virtual disk parameters	Displays the properties of the selected virtual disk. You can modify the cache write policy and read policy from the menu.
Manage preserved cache	Preserves the dirty cache from a virtual disk if it goes offline or is deleted. The dirty cache is preserved until you import the virtual disk or discard the cache.
Delete a virtual disk	Deletes the virtual disk and frees up disk space to create another virtual disk.
Delete a disk group	Deletes a disk group, which is a collection of disks from one or more disk subsystems controlled by the management software.

Physical disk management (PD Mgmt)

The **Physical Disk Management screen (PD Mgmt)** displays physical disk information and action menus. The screen displays physical disk IDs, vendor names, disk size, type, state, and disk group (DG). You can sort the list of physical disks based on the headings. You can perform several actions on the physical disks, including the following:

- Rebuilding physical disks
- Performing the Replace Member operation
- Setting the LED to blink
- Making a disk online or offline (unaffiliated with a disk group)
- Creating global hot spares
- Removing dedicated hot spares or global hot spares

The **PD Mgmt** screen also displays several physical disk properties as shown in the following table.

Table 12. Information on the Physical Disk Management Screen

Information Displayed in Left Panel	Supported Information Displayed in Right Panel
Physical Disk: <ul style="list-style-type: none">• Disk ID• Protocol type• Capacity (GB)• Physical Disk State• Disk Group• Vendor	<ul style="list-style-type: none">• Security Property of Physical Disk• Encryption Capable• Product ID• Firmware Revision• Disk Write Cache• S.M.A.R.T state• Physical Disk operation• Max Device Link Rate• Negotiated Link Rate• Dell Certified Disk (512 or 4k)

Physical disk actions

The following table describes the actions you can perform on physical disks. For procedures that can be used to perform the actions, see [Physical Disk Management \(PD Mgmt\)](#).

Table 13. Physical disk actions

Action	Description
Rebuild	Regenerates all data to a replacement disk in a redundant virtual disk (RAID level 1, 5, 6, 10, 50, or 60) after a disk failure. A disk rebuild normally occurs without interrupting normal operations on the affected virtual disk.
Replace Member	Replaces the disk in the virtual disk with another disk that can be selected.
LED Blinking	Indicates when physical disks are being used to create a virtual disk. You can choose to start or stop the LED blinking.
Force Online	Changes the state of the selected physical disk to online.

Action	Description
Force Offline	Changes the state of the selected physical disk so that it is no longer part of a virtual disk.
Make Global HS	Designates the selected physical disk as a global hot spare. A global hot spare is part of a pool for all virtual disks controlled by the controller.
Remove HS	Removes a dedicated hot spare from its disk group or a global hot spare from the global pool of hot spares.

Rebuild

Select **Rebuild** to rebuild one or more failed physical disks. For information on performing a physical disk rebuild, see [Performing A Manual Rebuild Of An Individual Physical Disk](#).

Several of the controller configuration settings and the virtual disk settings affect the actual rate of rebuild. The factors include the rebuild rate setting, virtual disk stripe size, virtual disk read policy, virtual disk write policy, and the amount of workload placed on the storage subsystem. For information on getting the best rebuild performance from your RAID controller, see the documentation at dell.com/storagecontrollermanuals.

The listed rates in the following table were taken during single disk failure with no I/O. Rates vary depending on type, speed and number of hard drives present in array; as well as which controller model and enclosure configuration are being used.

Table 14. Estimated rebuild rates

RAID Level	Number of Hard Drives	7.2 K rpm 12 Gbps SAS Hard Drive	15 K rpm 6 Gbps SAS Hard Drive
RAID 1	2	320 GB/hour	500 GB/hour
RAID 5	6	310 GB/hour	480 GB/hour
RAID 10	6	320 GB/hour	500 GB/hour
RAID 5	24	160 GB/hour	240 GB/hour
RAID 10	24	380 GB/hour	500 GB/hour

Controller management (Ctrl Mgmt)

The **Controller Management** screen (**Ctrl Mgmt**) displays the product name, package, firmware version, BIOS version, boot block version, controller ID, security capability, and security key presence. Use the screen to perform actions on the controller and BIOS. You can perform functions such as enable or disable the controller BIOS, enable or disable the BIOS during bootup in the event of BIOS errors, and enable or disable the option to **Auto Import**. In addition, you can select a virtual disk from which to boot, and select default settings.

Controller management actions

The following table describes the actions you can perform on the **Ctrl Mgmt** screen.

Table 15. Controller management options

Option	Description
Enable Controller BIOS	<p>Select the option to enable the controller BIOS. If the boot device is on the RAID controller, the BIOS must be enabled.</p> <p>Disable the BIOS to use other boot devices.</p> <p>In a multiple controller environment, you can enable the BIOS on multiple controllers. However, if you want to boot from a specific controller, then enable the BIOS on that controller and disable it on the other controllers. The system can then boot from the BIOS-enabled controller.</p>
Enable BIOS Stop On Error	<p>Select the option to stop the system BIOS during bootup if there are BIOS errors. The option enables you to enter the configuration utility to resolve the problem.</p> <p> WARNING: Do not enable the BIOS Stop On Error option when the system is operating in UEFI mode.</p>
Select Bootable Device	<p>Select the option to specify a virtual disk as the boot disk on the controller.</p> <p>The option is displayed if you have built virtual disks.</p>
Enable Auto Import	<p>Attempts to import every online foreign configuration during boot without having the need to access the BIOS Configuration Utility (<Ctrl><R>).</p>
Factory Default	<p>Select the option to restore the default settings for the options in the Settings box.</p>
Personality Mode	<p>Select this option to switch to the HBA mode. the default mode is RAID-mode.</p>

Foreign configuration view

When a foreign configuration is present, you can select **Foreign Configuration View** to display the configuration. The screen shows the foreign configuration as it would be if you import it. You can preview the foreign configuration before you decide whether to import it or clear it.

In some cases, a foreign configuration cannot be imported. If a physical disk in a virtual disk is rebuilding, the physical disk's state is set to **Rebuild**. Virtual disks that cannot be imported do not display the virtual disk target id.

The section Importing or Clearing Foreign Configurations Using the Foreign Configuration View Screen contains the procedures you can use to manage the foreign configurations.

 **NOTE:** The **BIOS Configuration Utility** (<Ctrl> <R>) reports error codes for failed imports of foreign configurations.

Virtual Disk Management

Creating virtual disks

 **NOTE:** Combining SAS and SATA disk drives within a virtual disk is not supported. Also, combining disk drives and SSDs within a virtual disk is not supported.

 **NOTE:** To create secured virtual disks, see [Security Key And RAID Management](#).

Perform the following steps to create a virtual disk:

1. During host system bootup, press <Ctrl><R> after the BIOS screen is displayed.
The **Virtual Disk Management** screen is displayed. If there is more than one controller, the main menu screen is displayed. Select a controller, and press <Enter>. The **Virtual Disk Management** screen is displayed for the selected controller.
2. Use the arrow keys to highlight the PERC 9 series of adapters, for example the **PERC H730P Adapter** or **Disk Group #**.
3. Press <F2>.
A list of available actions is displayed.
4. Select **Create New VD** and press <Enter>.
The **Create New VD** screen is displayed. The cursor is on the **RAID Level** option. When adding a virtual disk to a Disk Group, the **Add VD in Disk Group** screen is displayed. Skip to step 11 to change the basic settings of the virtual disk.
5. Press <Enter> to display the possible RAID levels.
6. Press the down-arrow key to select a RAID level and press <Enter>.
7. When creating a spanned virtual disk (RAID 50 or 60), enter the number of physical disks per span in the **PD per Span** field and press <Enter>.
8. Press <Tab> to move the cursor to the list of physical disks.
9. Use the arrow key to highlight a physical disk and press the spacebar, <Alt> , or <Enter> to select the disk.
10. Select additional disks, if required.
11. Press <Tab> to move the cursor to the **Basic Settings** box.
12. Set the virtual disk size in the **VD Size** field.
The virtual disk size is displayed in GB format.
13. Press <Tab> to access the **VD Name** field, and type a virtual disk name.
14. Press <Tab> to move the cursor to **Advanced** settings
15. Press the spacebar to make the settings active so that you can change them.
An **X** is displayed beside **Advanced** settings. The settings are the **stripe size**, **read policy**, **write policy**, and **disk cache policy**. You can also choose advanced options such as forcing the cache policy to **Write-Back**, initializing the virtual disk, and configuring a dedicated hot spare. The default parameters are displayed. You can accept the defaults or change them. To change the virtual disk parameters, see Virtual Disk Parameters and Descriptions in [Setting up virtual disks](#).

Selecting virtual disk parameters

To select the virtual disk parameters:

1. On the **VD Mgmt screen**, press <Tab> to move the cursor to the parameters you want to change.
2. Press the down-arrow key to expand the parameters and scroll down the list of settings.
3. To change the stripe element size, press <Tab> to highlight **Stripe Size**.
4. Press <Enter> to display the list of stripe element sizes (64 KB, 128 KB, 256 KB, 512 KB, and 1 MB).
The default stripe size is 64 KB.
5. Press the down-arrow key to highlight the desired option and press <Enter>.
6. To change the read policy, press <Tab> to move the cursor to **Read Policy**.
7. Press <Enter> to display the options (**No Read Ahead** or **Read Ahead**).
8. Press the down-arrow key to highlight the desired option and press <Enter>.
9. To change the write policy, press <Tab> to move the cursor to **Write Policy**.
10. Press <Enter> to display the options (**Write-Through**, **Write Back**).
11. Press the down-arrow key to highlight an option and press <Enter>.
12. Press <Tab> to move the cursor to **Force WB with no battery** and press <Enter>.

 **NOTE:** If you chose **Write-Through** as the write policy, then the option **Force WB with no battery** is not available.

 **CAUTION:** Do not initialize virtual disks when attempting to recreate an existing configuration.

13. Press <Tab> to move the cursor to **Initialize** and press <Enter>.

 **NOTE:** Fast initialization is performed at this stage.

14. Press <Tab> to move the cursor to **Configure Hot Spare** and press <Enter>.

 **NOTE:** The hot spare created at the stage is a dedicated hot spare.

15. If you have chosen to create hot spares in the earlier steps, a pop-up window is displayed where disks with appropriate sizes are displayed. Press the <spacebar> to select the disk size.
16. After you select the disk size, click **OK** to finalize the selection or click **Cancel** to forfeit the selection.
17. Select **OK** to accept the settings and press <Enter> to exit the window or select **Cancel** and press <Enter> to exit if you do not want to change any virtual disk parameters.

Initializing virtual disks

 **CAUTION:** A full initialization permanently destroys any existing data on that virtual disk.

Perform the following steps to initialize virtual disks:

1. On the **VD Mgmt screen**, select **Virtual Disk #** and press <F2> to display the menu of available actions.
2. Select **Initialization** and press the right-arrow key to display the **Initialization** submenu options.
3. Select **Start Init.** to begin a regular initialization or select **Fast Init.** to begin a fast initialization.
A pop-up window is displayed indicating that the virtual disk has been initialized.
4. Repeat the procedures from step 1 to step 3 to configure another virtual disk.

 **NOTE:** The current configured virtual disks display on the screen.

Checking data consistency

Select the **Consistency Check (CC)** option in the configuration utility to verify the redundancy data in virtual disks that use RAID levels 1, 5, 6, 10, 50, and 60 (RAID 0 does not provide data redundancy).

If you attempt to run a **Consistency Check** on a virtual disk that has not been initialized, the following error message is displayed:

The virtual disk has not been initialized. Running a consistency check may result in inconsistent message in the log. Are you sure you want to continue?

- Select **Yes** to proceed with running a CC.
- Select **No** to terminate the operation.

Running a data consistency check

To perform a data consistency check:

1. Press **<Ctrl> <N>** to access the **VD Mgmt** menu screen.
2. Press the down-arrow key to highlight **Virtual Disk #**.
3. Press **<F2>** to display the menu of available actions.
4. Press the down-arrow key to select **Consistency Check**.
5. Press the right-arrow key to display the available actions (**Start, Stop**).
6. Select **Start** and press **<Enter>** to run a **Consistency Check**.
The **Consistency Check** runs and checks the redundancy data in the virtual disks.

Importing or clearing foreign configurations using the VD mgmt menu

When a foreign configuration exists, the BIOS screen displays the message `Foreign configuration(s) found on adapter`. In addition, a foreign configuration is displayed on the right side of the **Ctrl Mgmt** screen.

You can use the **VD Mgmt** menu to import the existing configuration to the RAID controller or clear the existing configuration. In addition, you can view the foreign configuration from the **Foreign View** tab without importing the configuration.

 **NOTE:** The controller does not allow import of configurations that results in more than 64 virtual disks.

 **NOTE:** To import a secured foreign configuration, see [Security Key And RAID Management](#).

Perform the following steps to import or clear foreign configurations:

1. During bootup, press **<Ctrl> <R>** when prompted by the BIOS screen.
The **VD Mgmt** screen is displayed by default.
2. On the **VD Mgmt** screen, highlight the **Controller #**.
3. Press **<F2>** to display the available actions.
4. Navigate to the **Foreign Config** option and press the right arrow key to display the available actions:
 - a. **Import**
 - b. **Clear**

 **NOTE:** Ensure that your virtual disk has all the physical disks by verifying that there are no physical disks marked as **Missing** in the foreign view page and that all the disks appear as expected before importing them.

5. Select **Import** to import the foreign configuration or **Clear** to delete the foreign configuration and then press <Enter>.

If you import the configuration, the **VD Mgmt** screen displays detailed configuration information. It includes information about the disk groups, virtual disks, physical disks, space allocation, and hot spares.

Importing or clearing foreign configurations using the foreign configuration view screen

 **NOTE:** To import a secured foreign configuration, see [Security Key And RAID Management](#).

If one or more physical disks are removed from a configuration, the configuration on those disks is considered a foreign configuration by the RAID controller.

You can use the **Foreign Config** screen to view information about the foreign configuration, such as disk groups, virtual disks, physical disks, space allocation, and hot spares. The foreign configuration data is displayed in the same format as configurations on the **VD Mgmt** screen. You can use the **VD Mgmt** screen to view the foreign configuration before importing. After you view the foreign configuration, you can either clear or import to the RAID controller.

 **NOTE:** Before you import the foreign configuration, review the configuration on the screen to ensure that it is the end result that you require.

You can use the **Foreign Config** screen to manage foreign configurations in the following cases:

- All the physical disks in a configuration are removed and re-inserted.
- Some of the physical disks in a configuration are removed and re-inserted.
- All the physical disks in a virtual disk are removed, but at different times, and then re-inserted.
- The physical disks in a non-redundant virtual disk are removed.

The following constraints apply to the physical disks that are considered for import:

- The disk state of a physical disk can change from the time the foreign configuration is scanned to when the actual import occurs. The foreign import occurs only on disks that are in the **Unconfigured Good** state.
- Disks in the failed or offline state cannot be imported.
- The firmware does not allow you to import more than eight foreign configurations.

To manage foreign configurations:

1. If all or some of the physical disks in a configuration are removed and reinserted, the controller considers the disks to have foreign configurations. Perform the following steps:
 - a. Select **Foreign Config** to display the foreign configuration information on the **Foreign Config** screen.
 - b. Press <F2> to display the options (**Import**, **Clear**).

 **NOTE:** You must have all the disks in the system before you perform the import operation.

- c. Select **Import** to import the foreign configuration to the controller or select **Clear** to delete the foreign configuration(s) from the re-inserted disk(s).

In the **Preview Configuration Data** window, the status of a physical disk that needs to be rebuilt is displayed as **Rebuild**.

 **NOTE:** When you import a foreign configuration, the dedicated hot spares in the configuration are imported as dedicated hot spares on two conditions — the associated virtual disk is already present or the associated virtual disk is also imported along with the configuration.

 **NOTE:** Start a consistency check immediately after the rebuild is complete to ensure data integrity for the virtual disks. For more information about checking data consistency, see [Checking Data Consistency](#).

2. If all the physical disks in a virtual disk are removed at different times and re-inserted, the controller considers the disks to have foreign configurations. Perform the following steps:

- a. Select **Foreign Configuration View** to display the complete virtual disk, across different foreign configurations and allow foreign configurations to be imported.
- b. Press <F2> to display the options **Import** and **Clear**.

 **NOTE:** You must have all the drives in the system before you perform the import operation.

- c. Select **Import** to merge the foreign configurations with the existing configuration on the controller or **Clear** to delete the foreign configuration(s) from the re-inserted disk(s).

If you select **Import**, all drives that were removed before the virtual disk became offline are imported, and then automatically rebuilt.

 **NOTE:** Start a consistency check immediately after the rebuild is complete to ensure data integrity for the virtual disks. For more information about checking data consistency, see [Checking Data Consistency](#).

3. If the physical disks in a non-redundant virtual disk are removed, the controller considers the disks to have foreign configurations. Perform the following steps:

- a. Select **Foreign Configuration View** to display the complete foreign configuration information.
- b. Press <F2> to display the options **Import** and **Clear**.
- c. Select **Import** to import the foreign configurations to the virtual disk or **Clear** to delete the foreign configuration(s) from the re-inserted disk(s).

No rebuilds occur after the import operation because there is no redundant data to rebuild the disks with.

Break mirror

A **Break Mirror** is performed only on RAID 1 arrays. It provides a way to 'split' the mirror and spin-down one of the hard disks, which can then be imported into the configuration of a different PERC 9 series controller. This can be a useful way to:

- Create a disk image that can be imported and booted on a different system.
- Assist in software or configuration testing, where half of the mirror can be removed to ensure configuration consistency.

 **NOTE:** The **Break Mirror** operation is not available within the booted operating system environment. It is only available in the **BIOS Configuration Utility** (<Ctrl> <R>) utility and the UEFI RAID configuration utility.

Break mirror in BIOS configuration utility

The RAID 1 virtual disk that you wish to split must be in an optimal state, and it cannot be running any other background tasks.

To use the **Break Mirror** feature, from the **BIOS Configuration Utility** Ctrl R, perform the following steps:

1. During boot up, press Ctrl R when prompted by the BIOS screen. If there is more than one controller in the system, choose the controller.
The **VD Mgmt** screen is displayed by default.
2. Highlight the appropriate **Disk Group**
3. Press F2 to display the available actions.
4. Choose **Break Mirror** and press <Enter>.

A dialog box is displayed describing the operation and asking if you are sure you want to perform the operation.

5. Select **Yes** to continue.

The exported disk (exporting configuration) spins down and the hard drive status LED starts flashing to identify which drive must be removed.

The remaining disk (exporting configuration) is in a degraded state until the missing member is replaced or rebuilt.

If there are any **Global or Dedicated Hot Spare** assigned, which fulfills the rebuild requirements for the degraded RAID 1 disk, a rebuild starts automatically. If there is no hot spare assigned, then an hot spare that meets all the requirements for the virtual disk must be assigned before the rebuild starts.



NOTE: Importing a broken mirror is the same as importing a foreign configuration. See [Importing Or Clearing Foreign Configurations Using VD Mgmt Menu](#). The imported virtual disk is in a degraded state until the missing member is rebuilt.

Managing preserved cache

If a virtual disk goes offline or is deleted goes of missing physical disks, the controller preserves the dirty cache from the virtual disk. The preserved dirty cache, known as pinned cache, is preserved until you import the virtual disk or discard the cache.



NOTE: Certain operations, such as creating a new virtual disk, cannot be performed if preserved cache exists. You have to enter the **BIOS Configuration Utility** (<Ctrl> <R>) to resolve the situation before you boot to the operating system. Messages are displayed notifying you that you must enter the **BIOS Configuration Utility** (<Ctrl> <R>) to discard the preserved cache or import the virtual disks with the preserved cache.



CAUTION: If there are any foreign configurations, it is strongly advised that you import the foreign configuration before you discard the preserved cache. Otherwise, you might lose data that belongs with the foreign configuration.

To manage the preserved cache:

1. On the **VD Mgmt** screen, click on a controller icon.
2. Press <F2> to display the available actions.
3. Select **Manage Preserved Cache**.

A message is displayed advising you to import the foreign configuration before you discard the preserved cache to avoid losing data belonging to the foreign configuration. Confirm whether you want to continue. The **Manage Preserved Cache** screen displays the affected virtual disks.

4. You can choose to discard the cache on the **Manage Preserved Cache** screen. If you press **Cancel**, the process is cancelled and the **Preserved Cache Retained** dialog box is displayed.

If you choose to discard the cache, you are prompted to confirm your choice. If you choose to retain the cache, a message is displayed to notify you that you cannot perform certain operations while the cache exists. Click **OK** to continue.

Managing dedicated hot spares

A dedicated hot spare automatically replaces a failed physical disk only in the selected disk group which the hot spare is part of.

A dedicated hot spare is used before a global hot spare is used. You can create dedicated hot spares or delete them on the **VD Mgmt** screen.

Perform the following steps to create or delete dedicated hot spares:

1. On the **VD Mgmt** screen, select **Disk Group #** and press <F2>.

The available menu options are displayed.

2. Select **Manage Ded. HS** and press <Enter>.

A screen displays a list of the current dedicated hot spares with an **X** beside them and the physical disks that are available to create dedicated hot spares.

 **NOTE:** The utility allows only disks of the same disk technology and of equal or greater size to be selected as dedicated hot spare.

3. Use the following instructions to create or delete a dedicated hot spare:

- Creating a dedicated hot spare

1. Press the down-arrow key to highlight an available physical disk.
2. Press the spacebar to select the disk.
3. Repeat step 1 to step 2 for each dedicated hot spare that you want to create.

 **NOTE:** An **X** is displayed beside the selected physical disk(s).

- Deleting a dedicated hot spare

1. Use the down-arrow key to highlight a current hot spare.
2. Press the spacebar to de-select the disk.
3. Repeat step 1 and step 2 for each dedicated hot spare that you want to delete.

4. Press <Enter> to confirm the changes.

The **VD Mgmt** screen displays the updated list of hot spares.

 **NOTE:** If a global hot spare or dedicated hot spare is removed, reinserted and imported, it regains its status as a hot spare. A dedicated hot spare becomes a global hot spare when the disk group it was assigned to protect is no longer present during import.

Deleting virtual disks

 **NOTE:** You cannot delete a virtual disk during an initialization.

 **NOTE:** Warning messages appear stating the effect of deleting a virtual disk. Click **OK** twice to complete the virtual disk deletion.

Perform the following steps in the **BIOS Configuration Utility** (<Ctrl> <R>) to delete the virtual disks:

1. Press <Ctrl> <N> to access the **VD Mgmt** screen.
2. Use the arrow keys to move the cursor to **Virtual Disks**.
3. Press <F2>.

The action menu is displayed.

4. Select **Delete VD** and press <Enter>.
5. If there are multiple virtual disks in a **Disk Group**, select **Total Free Capacity** for the Disk Group in the **VD Mgmt** screen.

The total amount of free space available in the **Disk Group** is displayed.

Deleting disk groups

You can delete disk groups using the **BIOS Configuration Utility** (<Ctrl> <R>). When you delete a disk group, the utility also removes the virtual disks in that disk group.

To delete disk groups, perform the following steps in the **BIOS Configuration Utility** (<Ctrl> <R>):

1. Press <Ctrl> <N> to access the **VD Mgmt** screen.
2. Use the arrow keys to move the cursor to **Virtual Disks**.
3. Press <F2>.

The action menu is displayed.

4. Select **Delete Disk Group** and press <Enter>.

The disk group is deleted.



NOTE: When you delete a disk group, the remaining disk groups with higher numbers are automatically renumbered. For example, if you delete disk group #2, then disk group #3 is automatically renumbered as disk group #2.

Clearing the configuration

To clear the configuration, perform the following steps in the **BIOS Configuration Utility** (<Ctrl> <R>):

1. Press <Ctrl> <N> to access the **VD Mgmt** screen.
2. Select the **controller** using the arrow keys
3. Press <F2>.

The action menu is displayed.

4. Select **Clear Config**.

A pop-up window is displayed prompting for confirmation to delete all virtual disks.

5. Select **YES** to delete the virtual disks or **NO** to retain the configurations.

Physical Disk Management

Setting LED blinking

The LED blinking option indicates when physical disks are being used to create a virtual disk. You can choose to start or stop the LED blinking.

Following the below procedures to set **LED Blinking**:

1. Press <Ctrl> <N> to access the **PD Mgmt** screen.
A list of physical disks is displayed. The status of the each disk is displayed under the heading **State**.
2. Press the down-arrow key to highlight a physical disk.
3. Press <F2> to display the menu of available actions.
4. Press the down-arrow key to highlight **LED Blinking**.
5. Press the right-arrow key to display the available actions, **Start** and **Stop**.
6. Select **Start** to begin LED blinking or **Stop** to end LED blinking.

Creating global hot spares

You can use a global hot spare to replace a failed physical disk in any redundant array as long as the capacity of the global hot spare is equal to or larger than the coerced capacity of the failed physical disk. Perform the following steps to create global hot spares:

1. Press the down-arrow key to highlight a physical disk to change to a global hot spare.
2. Press <F2> to display the menu of available actions.
3. Press the down-arrow key to highlight **Make Global HS** and press <Enter>.

The physical disk is changed to a global hot spare. The status of the physical disk as a global hot spare is displayed under the heading **State**.

 **NOTE:** To replace a failed physical disk global hot spares must use the same disk technology and must be equal or greater in size.

 **NOTE:** To change additional physical disks to global hot spares, follow step 1 to step 4.

Removing global or dedicated hot spares

You can remove one global or dedicated hot spare at a time on the **PD Mgmt** screen. Perform the following steps to remove a global hot spare or dedicated hot spare:

1. Press <Ctrl> <N> to access the **PD Mgmt** screen.
A list of physical disks is displayed. The status of the each disk is displayed under the heading **State**.
2. Press the down-arrow key to highlight a physical disk that is a hot spare.
3. Press <F2> to display the menu of available actions.
4. Press the down-arrow key to select **Remove Hot Spare** from the list of actions and press <Enter>.

The physical disk is changed to the **Ready** state. The status of the physical disk is displayed under the heading **State**.

 **NOTE:** Try to use physical disks of the same capacity in a specific virtual disk. If you use physical disks with different capacities in a virtual disk, all physical disks in the virtual disk are treated as if they have the capacity of the smallest physical disk.

 **NOTE:** To remove additional global or dedicated hot spares, follow step 1 to step 4.

Replacing an online physical disk

In addition to the automatic **Replace Member** operation, you can manually replace any physical disk that is part of a virtual disk using the **Replace Member** functionality. Perform the following steps to replace a physical disk:

1. In the **Virtual Disk Management** window, select **Virtual Disk #** and press the down-arrow key until **Physical Disks** is highlighted.
2. Press the right-arrow key to expand the list of physical disks that are members of the virtual disk.
3. Press the down-arrow key and highlight the desired physical disk you want to replace. Press <F2> to expand the list of allowed operations on the disk.
4. Select **Replace**.
5. Select **Start**.
6. Press the down-arrow to highlight a replacement disk and then press the spacebar to select the disk.
7. Select **OK** to start the replacement.



NOTE: The replacement disk must be a hot spare or an unconfigured disk without a foreign configuration. It must have the same or greater capacity and should be of the same type as the disk it is replacing.

Restrictions and limitations

The following restrictions and limitations apply to the **Replace Member** operation:

- The **Replace Member** functions are restricted to one per array for RAID 0, RAID 1, and RAID 5, and two per array for RAID 6.
- The **Replace Member** function and rebuild cannot run simultaneously on a RAID 6 virtual disk. The rebuild operation has a higher priority, and the **Replace Member** operation is aborted if a rebuild begins.
- The **Replace Member** function and rebuild cannot run simultaneously on a RAID 6 virtual disk. The rebuild operation has a higher priority, and the **Replace Member** operation is aborted if a rebuild begins.

Stopping background initialization

Background initialization (BGI) is the automated operation in which parity is created and written. BGI does not run on RAID 0 virtual disks. Under certain conditions, the **BIOS Configuration Utility** (<Ctrl> <R>) displays a message if you want to stop a BGI in progress. An alert message is displayed if a BGI is in progress and you start any of the following actions:

- A Full Initialization on the virtual disk
- A Fast Initialization on the virtual disk
- A Consistency Check on the virtual disk

The following alert message is displayed:

```
The virtual disk is undergoing a background initialization process. Would you
like to stop the operation and proceed with the <full initialization/quick
initialization/consistency check> instead?
```

Click **Yes** to stop the BGI and start the requested operation or **No** to allow the BGI to continue.

Performing a manual rebuild of an individual physical disk



CAUTION: If a physical disk is a member of a disk group that contains multiple virtual disks and one of the virtual disks is deleted when a rebuild operation is in progress, the rebuild operation stops. You can then resume the rebuild operation manually using a storage management application. To avoid interruption, ensure that none of the virtual disks are deleted until the rebuild is complete.

Follow the procedures below to rebuild one failed physical disk manually:

1. Press <Ctrl> <N> to access the **PD Mgmt** screen.
A list of physical disks is displayed. The status of each disk is displayed under the heading **State**.
2. Press the down-arrow key to highlight a physical disk that is in failed state.
3. Press <F2> to display a menu of available actions.
The **Rebuild** option is highlighted at the top of the menu.
4. Press the right-arrow key to display the rebuild options and select **Start**.
5. After you start the rebuild, press <Esc> to display the previous menu.

 **NOTE:** You can also use the **VD Mgmt** screen to perform a manual rebuild. Use the arrow key to highlight a physical disk, and press <F2>. In the menu that is displayed, select the **Rebuild** option.

Controller Management

Enabling boot support

 **NOTE:** See your system documentation to ensure the proper boot order is selected in the system BIOS.

In a multiple controller environment, you can enable BIOS on multiple controllers. However, if you want to boot from a specific controller, enable the BIOS on that controller and disable it on the other controllers. The system can then boot from the BIOS-enabled controller. Perform the following steps to enable the controller BIOS:

1. Press <Ctrl> <N> to access **Ctrl Mgmt** menu screen.
2. Press <Tab> to move the cursor to **Enable Controller BIOS** in the **Settings** box.
3. Press the spacebar to select **Enable Controller BIOS**.
An **X** is displayed beside **Enable Controller BIOS**.
4. Press <Tab> to move the cursor to the **Apply** button, and then press <Enter> to apply the selection.
The controller BIOS is enabled.
To disable the controller BIOS, use the spacebar to de-select the **Enable Controller BIOS** control, and then select **Apply** and press <Enter>.

Enabling boot support for a BIOS-enabled controller

1. Press <Ctrl> <N> to access the **Ctrl Mgmt** menu screen.
2. Press <Tab> to move the cursor to the **Select Boot Device** in the **Settings** box.
3. Press the down-arrow key to display a list of virtual disks.
4. Use the down-arrow key to highlight a virtual disk.
5. Press <Enter> to select the disk.
6. Press <Tab> to move the cursor to the **Apply** button, and then press <Enter> to apply the selection.
Boot support is enabled for the selected controller.

Enabling BIOS stop on error

BIOS stop on error is used to stop the system from booting if there are BIOS errors. Perform the following steps to **Enable BIOS Stop on Error**.

1. Press <Ctrl> <N> to access the **Ctrl Mgmt** menu screen.
2. Press <Tab> to move the cursor to **Enable BIOS Stop on Error** in the **Settings** box.
3. Press the spacebar to select **Enable BIOS Stop on Error**.
An **X** is displayed beside **Enable BIOS Stop on Error**.
4. Press <Tab> to move the cursor to the **Apply** button, and then press <Enter> to apply the selection.
The controller BIOS is enabled.

Disabling BIOS stop on error

To disable BIOS stop on error:

1. Use the spacebar to de-select **Enable BIOS Stop On Error**.
2. Select **Apply** and press <Enter>. The **BIOS Stop On Error** is disabled.

Enabling auto import

If there is a native configuration present on the controller, the option **Enable Auto Import** automatically imports every online foreign configuration during boot without having the need to access the **BIOS Configuration Utility** (<Ctrl> <R>).

 **NOTE:** The controller automatically imports every optimal and degraded foreign configuration without enabling the feature if there is no native configuration on the controller.

To enable auto import:

1. Press <Ctrl> <N> to access the **Ctrl Mgmt** menu screen.
2. Press <Tab> to move the cursor to **Enable Auto Import** in the **Settings** box.
3. Press the spacebar to select **Enable Auto Import**. An **X** is displayed beside **Enable Auto Import**.
4. Press <Tab> to move the cursor to the **Apply** button, and then press <Enter> to apply selection. The auto import is enabled.

Disabling auto import

To disable auto import:

1. Use the spacebar to de-select **Enable Auto Import**.
2. Select **Apply** and press <Enter>. The auto import is disabled.

Restoring factory default settings

You can use the **Ctrl Mgmt** menu screen to restore the default settings for the options in the **Settings** box. The settings are **Enable Controller BIOS**, **Enable BIOS Stop on Error**, and **Enable Auto Import**. Perform the following steps to restore default settings:

1. Press <Ctrl> <N> to access the **Ctrl Mgmt** menu screen.
2. Press <Tab> to move the cursor to the **Settings** box.
3. Use the spacebar to de-select the settings for the options in the **Settings** box.
4. Press <Tab> to move the cursor to the **Factory Default** box, and press <Alt>, <Enter>, or the spacebar. A dialog box is displayed for you to confirm your choice.
5. Select **Ok** and press <Enter>. The defaults are automatically selected for the controller settings and are displayed in **Settings**.

UEFI/HII RAID configuration utility

The UEFI (Unified Extensible Firmware Interface) RAID configuration utility is a storage management application integrated into the System BIOS <F2>. It is used to configure and manage RAID disk groups, virtual disks, and physical disks. This utility is independent of the operating system.

 **NOTE:** The following sections provide information about using the UEFI RAID configuration utility. For more information, see the online help option in the UEFI RAID configuration utility.

 **NOTE:** Use the UEFI RAID configuration utility for initial setup and disaster recovery. Certain advanced features are also offered in the utility.

Entering the UEFI configuration utility

Perform the following steps to boot to the UEFI configuration utility:

1. Turn on the system.
2. While the system startup, press <F2> to enter **System Setup**.
Displays the list of menu in the **System Setup Main Menu** screen.
3. Click **Device Settings**.
Device Settings list all the RAID controllers in the system.

To access the management menu for the controller, use the arrow keys or the mouse.

 **NOTE:** For more information in all the options, click **Help** that is available on the top right-hand corner of the browser screen. Help information for individual option menus can also be viewed by scrolling down on each option.

 **NOTE:** Some of the options within the UEFI RAID configuration utility are not present if the controller does not support the corresponding feature. Options may also be grayed out if the feature is supported in existing configuration.

Exiting the UEFI configuration utility

To exit the UEFI configuration utility, perform the following steps:

1. Click **Finish** at the bottom-right corner on the **System Setup Main Menu** screen.
Displays a warning message to confirm your choice.
2. Click **Yes** to exit the configuration utility.

Navigating to Dell PERC 9 configuration utility

1. Enter the UEFI configuration Utility. See [Entering the UEFI configuration utility](#).

The **Device Settings** screen displays a list of NIC ports and the Dell PERC 9 configuration utility.

2. To enter PERC 9 configuration utility, click **Dell PERC 9 Configuration Utility**.

Displays the list of **Configuration Options**:

- **Controller Management** — allows you to configure, manage, and view the controller properties.
- **Virtual Disk Management** — allows you to configure, manage, and view the virtual disk properties
- **Physical Disk Management** — allows you to configure, manage, view and perform varied operations on the physical disk properties.

Configuration management

Creating virtual disks

1. Enter the **Dell PERC 9 Configuration Utility**. See [Navigating to PERC 9 Configuration Utility](#).
2. Click **Configuration Management** → **Create Virtual Disks**.
3. Select the RAID level by selection the radio button next to the available RAID configurations.
4. If you want to create a secured virtual disk, select **Secure Virtual Disk**.

 **NOTE:** The **Secure Virtual Disk** option is enabled and selected by default, only if the security key has been configured. Only SED physical disks are listed.

5. If you want to protect the virtual disk data, select **Use Data Protection**.

 **NOTE:** The **Use Data Protection** option is enabled only if the storage controller supports protection of data. Virtual disks can be created with a mix of physical disks that are both capable of data protection or not.

6. Select one of the following physical disk capacities:
 - **Unconfigured Capacity:** Creates a virtual disk on unconfigured physical disks.
 - **Free Capacity:** Utilizes unused physical disk capacity that is already part of a virtual disk.
7. To select the physical disks from which the virtual disks are being created, click **Select Physical Disks**. This option is displayed if you select **Unconfigured Capacity** as your physical disk capacity.
8. To select the disk groups from which the virtual disks are being created, click **Select Disk Group**. This option is displayed if you select **Free Capacity** as your physical disk capacity.
9. Specify the name for the virtual disk in the **Virtual Disk Name** field.
10. Specify the size of the virtual disk in the **Virtual Disk Size** field.
11. Select the unit for the virtual disk size.
12. Specify the read policy for the virtual disk. The options for read policy are:
 - **No Read Ahead**
 - **Read Ahead**
13. Specify the write policy for the virtual disk. The options for read policy are:
 - **Write Back**
 - **Write Through**
 - **Force Write Back**
14. Select the cache setting of the virtual disk. You can either enable or disable the cache setting for the virtual disk.
15. Select the virtual disk initialization method. The options are:
 - **No:** The virtual disk is not initialized.
 - **Fast:** The first 8 MB of the virtual disk is initialized.

- **Full:** The entire virtual disk is initialized.
16. Click **Create Virtual Disk** and the virtual disks are created with the specified parameters.

Creating profile based virtual disks

1. Enter the **Dell PERC 9 Configuration Utility**. See [Navigating to PERC 9 Configuration Utility](#).
2. Click **Configuration Management** → **Create Profile Based Virtual Disks**.
3. Select the RAID type. The following are the options available:
 - Generic RAID 0
 - Generic RAID 1
 - Generic RAID 5
 - Generic RAID 6
4. Based on the RAID mode selected, one or more the physical disk selection criteria are displayed. Select a criteria based your requirement.
The **Profile Parameters** of the selected option is displayed.
5. Click **Create Virtual Disk**.
6. Select **Confirm** and click **Yes** to continue.

The virtual disk is created with the parameters of the profile selected.

Converting physical disks to RAID capable disk

1. Enter the **Dell PERC 9 Configuration Utility**. See [Navigating to PERC 9 Configuration Utility](#).
2. Click **Controller Management** → **Convert to RAID Capable Disk**.
3. Select the physical disk to convert to RAID capable disk.
4. Click **OK**.
A screen is displayed asking if you are sure you want to perform the operation.
5. Click **Yes** to continue.

Converting physical disks to non-RAID disk

1. Enter the **Dell PERC 9 Configuration Utility**. See [Navigating to PERC 9 Configuration Utility](#).
2. Click **Configuration Management** → **Convert to Non-RAID Disk**.
3. Select **Select Physical Disks to Convert to Non-RAID**.
4. Select the physical disk and click **OK**.
A screen is displayed asking if you are sure you want to perform the operation.
5. Click **Yes** to continue.



Viewing disk group properties

1. Enter the **Dell PERC 9 Configuration Utility**. See [Navigating to PERC 9 Configuration Utility](#).
2. Click **Configuration Management** → **View Global Hot Spares**.
All the hot spare disks that are assigned to the RAID controller are displayed.

Viewing disk group properties

1. Enter the **Dell PERC 9 Configuration Utility**. See [Navigating to PERC 9 Configuration Utility](#).
2. Click **Configuration Management** → **View Disk Group Properties**.

- You can view the following properties of the disk group:

Option	Description
Capacity Allocation	Displays the associated virtual disks for the disk group and the available free capacity, if any.
Secured	Indicates if the disk group is secured.
Protected	Indicated if the disk group is protected.  NOTE: You can select the disk group for protection only at the time of the creation of the disk group.
Assigned Dedicated Hot Spare	Displays information about the hot spares dedicated to the disk group.  NOTE: A single hot spare disk can be assigned to multiple disk groups.

Managing foreign configurations on a RAID controller

- Enter the **Dell PERC 9 Configuration Utility**. See [Navigating to PERC 9 Configuration Utility](#).
- Click **Configuration Management** → **Manage Foreign Configuration** → **Preview Foreign Configuration**.
The list of the existing configurations are displayed.
- Click **Import Foreign Configuration** to import all the foreign configurations.
A screen is displayed asking if you are sure you want to perform the operation.
- Click **Yes** to continue.

Deleting existing configurations on a RAID controller

- Enter the **Dell PERC 9 Configuration Utility**. See [Navigating to PERC 9 Configuration Utility](#).
- Click **Configuration Management** → **Clear Configuration**.
- Click **OK**.
A screen is displayed asking if you are sure you want to perform the operation.
- Click **Yes** to continue.

Controller management

Restoring factory settings for the controller

- Enter the **Dell PERC 9 Configuration Utility**. See [Navigating to PERC 9 Configuration Utility](#).
- Click **Controller Management** → **Set Factory Defaults**.
- Click **OK**.
A screen is displayed asking if you are sure you want to perform the operation.
- Click **Yes** to continue.

Saving controller events

- Enter the **Dell PERC 9 Configuration Utility**. See [Navigating to PERC 9 Configuration Utility](#).
- Click **Controller Management** → **Save Controller events**.
- Select the file system.
- Select the directory in which the log file containing the controller events, are to be saved.
- Specify the name of the log file into which the controller events are saved.

6. Click **Save Events**.
A screen is displayed asking if you are sure you want to perform the operation.
7. Click **Yes** to continue.

Enabling security for the controller

1. Enter the **Dell PERC 9 Configuration Utility**. See [Navigating to PERC 9 Configuration Utility](#).
2. Click **Controller Management** → **Enable Security**.
3. Select the security mode from the list of options displayed under the **Choose the Security Key Management Mode**.
4. Click **OK**.
A screen is displayed asking if you are sure you want to perform the operation.
5. Click **Yes** to continue.

Saving debug log

1. Enter the **Dell PERC 9 Configuration Utility**. See [Navigating to PERC 9 Configuration Utility](#).
2. Click **Controller Management** → **Save Debug Log**.
3. Select the file system.
4. Select the directory in which the log file containing the controller events, are to be saved.
5. Specify the name of the log file into which the controller events are saved.
6. Click **Save log**.
A screen is displayed asking if you are sure you want to perform the operation.
7. Click **Yes** to continue.

Switching the controller to HBA mode

 **NOTE:** Prior to switching the controller from the RAID mode to the HBA mode, ensure that you review the pre-requisites. For more information see the [Prerequisites for RAID to HBA mode transition](#).

1. Enter the **Dell PERC 9 Configuration Utility**. See [Navigating to PERC 9 Configuration Utility](#).
2. Click **Controller Management** → **Switch to HBA mode**.
The controller is switched to the HBA mode. You must reboot the system for the change to be effected.
3. Click **OK**.
A screen is displayed asking if you are sure you want to perform the operation.
4. Click **Yes** to continue.

Prerequisites for RAID to HBA mode transition

The following steps must be taken before switching from RAID mode to HBA mode:

- All virtual disks must be removed or deleted,
- Hot spare disks must be removed or re-purposed.
- All foreign configurations must be cleared or removed.
- All physical disks in a failed state, must be removed.
- Any local security key associated with SEDs must be deleted.

Switching the controller to RAID mode

1. Enter the **Dell PERC 9 Configuration Utility**. See [Navigating to PERC 9 Configuration Utility](#).
2. Click **Controller Management** → **Switch to RAID mode**.
The controller is switched to the RAID mode. You must reboot the system for the change to be effected.

 **NOTE:** All physical disks retain their non-RAID status until converted to Unconfigured Good (UG) following a successful transition to RAID mode.

3. Click **OK**.
A screen is displayed asking if you are sure you want to perform the operation.
4. Click **Yes** to continue.

Virtual disk management

Viewing virtual disk properties

1. Enter the **Dell PERC 9 Configuration Utility**. See [Navigating to PERC 9 Configuration Utility](#).
2. Click **Virtual Disk Management**.
All the virtual disks associated with the RAID controller are displayed.
3. To view the properties, click on the virtual disk. You can view the following properties of the Virtual disk:

Option	Description
Operation	Displays the lists of operations you can perform on the selected virtual disk. The options are: <ul style="list-style-type: none">• Blink• Unblink• Delete Virtual Disk• Reconfigure Virtual Disks
Name	Indicates the name of the virtual disk.
RAID level	Indicates the RAID level of the virtual disk.
Size	Indicates the size of the virtual disk.

Viewing physical disks associated with a virtual disk

1. Enter the **Dell PERC 9 Configuration Utility**. See [Navigating to PERC 9 Configuration Utility](#).
2. Click **Virtual Disk Management**.
All the virtual disks associated with the RAID controller are displayed.
3. Click on a virtual disk.
The properties of the virtual disk are displayed.
4. Click **View Associated Physical Disks**.
All the physical disks that are associated with the virtual disk are displayed.
5. Select the physical disk and click **View Physical Disk Properties** to view the physical disk properties.

Physical disk management

Viewing physical disk properties

1. Enter the **Dell PERC 9 Configuration Utility**. See [Navigating to PERC 9 Configuration Utility](#).
2. Click **Physical Disk Management**.
All the physical disks associated with the RAID controller are displayed.
3. To view the properties, click on the physical disk. You can view the following properties of the physical disk:

Option	Description
Operation	Displays the lists of operations you can perform on the selected physical disk. The options are: <ul style="list-style-type: none">• Blink• Unblink• Delete Virtual Disk• Reconfigure Virtual Disks
Physical Disk ID	Indicates the unique identifier of the physical disk.
Status	Indicates the status of the physical disk.
Size	Indicates the size of the physical disk.
Type	Indicates the type of the physical disk.
Model	Indicates the model of the physical disk.
Part Number	Indicates the part number of the physical disk.
Serial Number	Indicates the serial of the physical disk.
Manufacturing Date	Indicates the date on which the physical disk has been manufactured
Associated Virtual Disks	Displays the virtual disks associated with the physical disk.

4. Click **Advanced...**
The additional advanced properties of the physical disk is displayed.



NOTE: When you select the **Patrol Read** option in the **Advanced...** section, an error message may be displayed. The error message can be safely ignored.

Hardware components management

Viewing battery properties

1. Enter the **Dell PERC 9 Configuration Utility**. See [Navigating to PERC 9 Configuration Utility](#).
2. Click **Hardware Components** → **Advanced Hardware Components** → **Battery Management**.
The properties of the are displayed.
3. You can view the following properties of the battery:

Field	Description
Status	Indicates the status of the battery
Temperature	Indicates the current temperature of the battery and also indicates whether the temperature is Normal or High .
Charge	Indicates the available charge of the battery in percentage.

4. Click **Advanced...**

The additional advanced properties of the physical battery are displayed.

Viewing physical disks associated with an enclosure

1. Enter the **Dell PERC 9 Configuration Utility**. See [Navigating to PERC 9 Configuration Utility](#).
2. Click **Hardware Components** → **Advanced Hardware Components** → **Enclosure Management**.
3. Click the **Attached Physical Disks** drop-down box on a virtual disk.

All the physical disks that are associated with the virtual disk are displayed.

Configuring FastPath-capable virtual disks

All simple virtual disks configured with write cache policy Write Through and read cache policy No Read Ahead can utilize FastPath. Only IO block sizes smaller than virtual disk's stripe size are eligible for FastPath. In addition, there should be no background operations (rebuild, initialization) running on the virtual disks. FastPath will not be used if these operations are active.

 **NOTE:** RAID 50, and RAID 60 virtual disks cannot use FastPath.

The following table summarizes the FastPath-eligibility of read and write IOs across the supported RAID levels.

Table 16. FastPath eligibility across supported RAID levels

	RAID 0	RAID 1	RAID 5	RAID 6	RAID 10
Read	Yes	Yes (Optimal and Degraded)	Yes (Optimal and Degraded)	Yes (Optimal and Degraded)	Yes (Optimal)
Write	Yes	No	No	No	No

Controller Management

Controller management (Ctrl Mgmt)

The **Controller Management** screen (**Ctrl Mgmt**) displays the product name, package, firmware version, BIOS version, boot block version, controller ID, security capability, and security key presence. Use the screen to perform actions on the controller and BIOS. You can perform functions such as enable or disable the controller BIOS, enable or disable the BIOS during bootup in the event of BIOS errors, and enable or disable the option to **Auto Import**. In addition, you can select a virtual disk from which to boot, and select default settings.

Controller management actions

The following table describes the actions you can perform on the **Ctrl Mgmt** screen.

Table 17. Controller management options

Option	Description
Enable Controller BIOS	<p>Select the option to enable the controller BIOS. If the boot device is on the RAID controller, the BIOS must be enabled.</p> <p>Disable the BIOS to use other boot devices.</p> <p>In a multiple controller environment, you can enable the BIOS on multiple controllers. However, if you want to boot from a specific controller, then enable the BIOS on that controller and disable it on the other controllers. The system can then boot from the BIOS-enabled controller.</p>
Enable BIOS Stop On Error	<p>Select the option to stop the system BIOS during bootup if there are BIOS errors. The option enables you to enter the configuration utility to resolve the problem.</p> <p> WARNING: Do not enable the BIOS Stop On Error option when the system is operating in UEFI mode.</p>
Select Bootable Device	<p>Select the option to specify a virtual disk as the boot disk on the controller.</p> <p>The option is displayed if you have built virtual disks.</p>
Enable Auto Import	<p>Attempts to import every online foreign configuration during boot without having the need to access the BIOS Configuration Utility (<Ctrl><R>).</p>
Factory Default	<p>Select the option to restore the default settings for the options in the Settings box.</p>
Personality Mode	<p>Select this option to switch to the HBA mode. the default mode is RAID-mode.</p>

Dirty cache data error message

Error Message: The following virtual disks are missing: (x). If you proceed (or load the configuration utility), these virtual disks will be removed from your configuration. If you wish to use them at a later time, they will have to be imported. If you believe these virtual disks should be present, please power off your system and check your cables to ensure all disks are present. Press any key to continue, or 'C' to load the configuration utility. The cache contains dirty data, but some virtual disks are missing or will go offline, so the cached data cannot be

written to disk. If this is an unexpected error, then please power off your system and check your cables to ensure all disks are present. If you continue, the data in cache will be permanently discarded. Press 'X' to acknowledge and permanently destroy the cached data.

Probable Cause: The controller preserves the dirty cache from a virtual disk if the disk becomes offline or is deleted because of missing physical disks. This message indicates that some configured disks were removed. If the disks were not removed, they are no longer accessible. The SAS cables for your system might be improperly connected.

Corrective Action: Check the cable connections and fix any problems. Restart the system. Use the <Ctrl> <R> utility to import the virtual disk or discard the preserved cache. For the steps to manage preserved cache, see [Managing The Preserved Cache](#).

Discovery error message

Error Message: A discovery error has occurred, please power cycle the system and all the enclosures attached to this system.

Probable Cause: This message indicates that discovery did not complete within 120 seconds. The SAS cables for your system might be improperly connected.

Corrective Action: Check the cable connections and fix any problems. Restart the system.

Drive Configuration Changes Error Message

Error Message: Entering the configuration utility in this state will result in drive configuration changes. Press 'Y' to continue loading the configuration utility or please power off your system and check your cables to ensure all disks are present and reboot.

Probable Cause: The message is displayed after another BIOS warning indicating there are problems with previously configured disks and you have chosen to accept any changes and continue. The SAS cables for your system might be improperly connected.

Corrective Action: Check the cable connections and fix any problems before restarting the system. If there are no cable problems, press any key or <Y> to continue.

Security key and RAID management

 **NOTE:** The H330 PERC card does not support security key and RAID management features.

Security key implementation

The Dell PowerEdge RAID Controller (PERC) 9 series of cards support Self-Encrypting Disks (SED) for protection of data against loss or theft of SEDs. Protection is achieved by the use of encryption technology on the drives. There is one security key per controller. You can manage the security key under Local Key Management (LKM). The key can be escrowed in to a file using Dell OpenManage storage management application. The security key is used by the controller to lock and unlock access to encryption-capable physical disks. In order to take advantage of this feature, you must:

1. Have SEDs in your system.
2. Create a security key.

Security key management in the BIOS configuration utility

The Dell OpenManage storage management application and the **BIOS Configuration Utility** (<Ctrl> <R>) of the controller allow security keys to be created and managed as well as create secured virtual disks. The following section describes the menu options specific to security key management and provide detailed instructions to perform the configuration tasks. The contents in the following section apply to the **BIOS Configuration Utility** (<Ctrl> <R>). For more information on the management applications, see [Management Application For PERC Cards](#).

- The Virtual Disk Management screen, **VD Mgmt**, is the first screen that is displayed when you access a RAID controller from the main menu screen on the **BIOS Configuration Utility** (<Ctrl> <R>). The following are security-related actions you can perform through the virtual disk management menu:
 - **Security Key Management**—Creates, changes, or deletes the security settings on a controller.
 - **Secure Disk Group**—Secures all virtual disks in disk group.
- The Physical Disk Management screen, **PD Mgmt**, displays physical disk information and action menus. The following are security-related actions you can perform through the physical disk management menu:
 - **Instant Secure Erase**—Permanently erases all data on an encryption-capable physical disk and resets the security attributes.

For more information on the Physical Disk Management screen and Virtual Disk Management screen, see [Physical Disk Management \(PD Mgmt\)](#) and [Virtual disk management](#) respectively.

Local Key Management (LKM)



You can use LKM to generate the key ID and the passphrase required to secure the virtual disk. You can secure virtual disks, change security keys, and manage secured foreign configurations using this security mode.

 **NOTE:** Under LKM, you are prompted for a passphrase when you create the key.

Creating a security key

 **NOTE:** There is no passphrase backup option when you create a security key; you need to remember your passphrase.

Perform the following steps to create a security key on the controller:



1. During the host system boot up, press <Ctrl> <R> when the BIOS screen is displayed.
The **Virtual Disk Management** screen is displayed.
If there is more than one controller, the main menu screen is displayed.
2. Select a controller, and press <Enter>.
The **Virtual Disk Management** screen is displayed for the selected controller.
3. Use the arrow keys to highlight **Security Key Management**.
4. Press <F2> to display the actions you can perform.
5. Select **Create Key** and press <Enter>.
The **Create Security Key** screen is displayed. The cursor is at the **Security Key Identifier**.
6. Enter an identifier for your security key.
 **NOTE:** The Security Key Identifier is a user supplied clear text label used to associate the correct security key with the controller.
7. Press <Tab> to enter a passphrase.
 **CAUTION:** If you lose or forget your passphrase, the data in your virtual disk is inaccessible.
8. Press <Tab> and select **OK** to accept the settings. Select **Cancel** to exit if you do not want to create a security key on the controller.

Changing the security key



 **NOTE:** Change Key is active if there is a security key present on the controller.

Perform the following steps when changing the security key on the controller:

1. During host system bootup, press <Ctrl> <R> when the BIOS screen is displayed.
The **Virtual Disk Management** screen is displayed.
If there is more than one controller, the main menu screen is displayed.
2. Select a controller, and press <Enter>.
The **Virtual Disk Management** screen is displayed for the selected controller.
3. Use the arrow keys to highlight **Security Key Management**.
4. Press <F2> to display the actions you can perform.
5. Select **Change Key** and press <Enter>.
The **Change Security Key** screen is displayed. The cursor is at the **Security Key Identifier**.

6. Enter an identifier for your Security Key.
7. Press <Tab> to enter a new passphrase.
 -  **NOTE:** You need to provide the current passphrase in order to change the security key on the controller.
8. Press <Tab> and select **OK** to accept the settings and to exit the window. Select **Cancel** to exit if you do not want to change the security key on the controller.
 -  **NOTE:** If there is an existing configuration on the controller, it is updated with the new security key. If you had previously removed any secured disks, you still need to supply the old passphrase to import them.

Deleting a security key

-  **NOTE:** Delete Key is active if there is a security key present on the controller.
-  **NOTE:** Delete Key can only be performed when there are no secured virtual disks present.
-  **NOTE:** After the Delete Key operation, all unconfigured, secured SEDs are secure-erased.

Perform the following steps when deleting the security key on the controller:

1. During host system bootup, press <Ctrl> <R> when the BIOS screen is displayed. The **Virtual Disk Management** screen is displayed. If there is more than one controller, the main menu screen is displayed.
2. Select a controller, and press <Enter>. The **Virtual Disk Management** screen is displayed for the selected controller.
3. Use the arrow keys to highlight **Security Key Management**.
4. Press <F2> to display the actions you can perform.
5. Select the **Delete Key** and press <Enter>.

Creating secured virtual disks

To create a secured virtual disk, the controller must have a security key established first. See [Creating Security Key](#).

-  **NOTE:** Combining SAS and SATA hard drives within a virtual disk is not supported. Also, combining hard drives and solid state drives (SSDs) within a virtual disk is not supported.

After the security key is established, perform the steps outlined in the topic [Creating virtual disks](#) to create a virtual disk.

To secure the virtual disk, navigate to the **Secure VD** option at the bottom left area of the **Create New VD** screen.

-  **NOTE:** All virtual disks added to a secured Disk Group are secured.

Securing pre-existing virtual disks

If an unsecured virtual disk was created on a controller, you can secure the virtual disk as long as the following conditions are met:

- The controller has a security key present.
- All the physical disks in the virtual disk are SED.





Perform the following steps when securing a pre-existing virtual disk on a secured controller:

1. During the host system bootup, press **<Ctrl> <R>** when the BIOS screen is displayed.
The **Virtual Disk Management** screen is displayed.
If there is more than one controller, the main menu screen is displayed.
2. Select a controller, and press **<Enter>**.
The **Virtual Disk Management** screen is displayed for the selected controller.
3. Use the arrow keys to highlight the **Disk Group** number.
4. Press **<F2>** to display a menu of the available actions.
5. Highlight the **Secure Disk Group** option and press **<Enter>**.



 **NOTE:** If you select to secure a Disk Group, all VDs part of the Disk Group are secured.

Importing or clearing secured foreign configurations and secure disk migration

Secured virtual disks created on a PERC 9 card can be migrated to another PERC 9 series card. A virtual disk secured with a security key different from the current controller security key cannot be imported without authentication of the original passphrase used to secure them. When importing secured virtual disk(s) created with a different security key, the secured foreign configuration(s) do not show in the **Foreign Configuration View** screen. Follow the steps below to import or clear a foreign secured virtual disk.

-  **NOTE:** If you are importing secured and unsecured virtual disks, you are prompted to resolve the secured foreign configuration first.
-  **NOTE:** The PERC 9 series of cards need to have a security key present before being able to import a secured virtual disk.
-  **NOTE:** Any unsecured virtual disks imported are still unsecured.
-  **NOTE:** If you are importing a virtual disk originally secured with a local key management (LKM), you are prompted for the passphrase used to secure that virtual disk.

Perform the following steps when importing a secured foreign virtual disk:

1. During the host system bootup, press **<Ctrl> <R>** when the BIOS screen is displayed.
The **Virtual Disk Management** screen is displayed.
If there is more than one controller, the main menu screen is displayed.
2. Select a controller, and press **<Enter>**.
The **Virtual Disk Management** screen is displayed for the selected controller.
3. Press **<F2>** to display a menu of available actions.
4. Select **Import** to import the foreign configuration or **Clear** to delete the foreign configuration. Press **<Enter>**.
 -  **NOTE:** To **Clear**, you need to **Instant Secure Erase** foreign configurations secured with a different security key.
5. If you select to **Import** the configuration, the **Secure Foreign Import** screen is displayed.
 -  **NOTE:** The key identifier for the passphrase used to secure the foreign secured virtual disks is displayed under the **Secured Drives** option.
6. Enter the passphrase that was used to secure the foreign configuration.

7. Press <Tab> and select **OK** to finish importing the secured foreign configuration or select **Cancel** to exit this menu.

If you select **Cancel** for the secured foreign import, the disks remain inaccessible until imported or instant secure erased. See [Instant Secure Erase](#).

Instant secure erase

Instant Secure Erase is the process of permanently erasing all data on an encryption-capable physical disk and resetting the security attributes. You need to execute **Instant Secure Erase** on SEDs that are inaccessible (blocked) due to a lost or forgotten passphrase.



CAUTION: By executing Instant Secure Erase, the data on your encryption-capable physical disk is lost.

To execute Instant Secure Erase:

1. Press <Ctrl> <N> to access the **PD Mgmt** screen.
A list of physical disks is displayed. On the right menu, the physical disk properties are displayed including information about whether the physical disk is secured or not.
2. Press the down-arrow key to highlight a physical disk that is secured.
3. Press <F2> to display a menu of available actions.
4. The **Secure Erase** option is highlighted at the bottom of the menu.
5. Press <Enter> to **Secure Erase** the physical disk and select **YES**.

Troubleshooting

To get help with your Dell PowerEdge RAID Controller (PERC) 9 series of cards, you can contact your Dell Technical Service representative or see dell.com/support.

BIOS configuration utility error messages

The controller BIOS read-only memory (ROM) provides Int 13h functionality (disk I/O) for the virtual disks connected to the controller. You can boot from or access the physical disks without a driver.

Discovery error message

Error Message: A discovery error has occurred, please power cycle the system and all the enclosures attached to this system.

Probable Cause: This message indicates that discovery did not complete within 120 seconds. The SAS cables for your system might be improperly connected.

Corrective Action: Check the cable connections and fix any problems. Restart the system.

Extra enclosure error message

Error Message: There are X enclosures connected to connector Y, but only maximum of 4 enclosures can be connected to a single SAS connector. Please remove the extra enclosures then restart your system.

Probable Cause: This message is displayed when the BIOS detects more than four enclosures connected to a single SAS connector.

Corrective Action: You must remove all additional enclosures and restart your system.

Missing disks in virtual disk error message

Error Message: The following virtual disks have missing disks: (x). If you proceed (or load the configuration utility), these virtual disks will be marked OFFLINE and will be inaccessible. Please check your cables and ensure all disks are present. Press any key to continue, or 'C' to load the configuration utility.

Probable Cause: The message indicates that some configured disks were removed. If the disks were not removed, they are no longer accessible. The SAS cables for your system might be improperly connected.

Corrective Action: Check the cable connections and fix any issues. Restart the system. If there are no cable problems, press any key or <C> to continue.

Previous configuration of disks removed error message

Error Message: All of the disks from your previous configuration are gone. If this is an unexpected message, then please power off your system and check your cables to ensure all disks are present. Press any key to continue, or press <C> to load the configuration utility.

Probable Cause: The message indicates that some configured disks were removed. If the disks were not removed, they are no longer accessible. The SAS cables for your system might be improperly connected.

Corrective Action: Check the cable connections and fix any issues before restarting the system. If there are no cable problems, press any key or <C> to continue.

Missing virtual disks error message

Error Message: The following virtual disks are missing: (x). If you proceed (or load the configuration utility), these virtual disks will be removed from your configuration. If you wish to use them at a later time, they will have to be imported. If you believe these virtual disks should be present, please power off your system and check your cables to ensure all disks are present. Press any key to continue, or 'C' to load the configuration utility.

Probable Cause: The message indicates that some configured disks were removed. If the disks were not removed, they are no longer accessible. The SAS cables for your system might be improperly connected.

Corrective Action: Check the cable connections and fix any issues. Restart the system. If there are no cable problems, press any key or <C> to continue.

Dirty cache data error message

Error Message: The following virtual disks are missing: (x). If you proceed (or load the configuration utility), these virtual disks will be removed from your configuration. If you wish to use them at a later time, they will have to be imported. If you believe these virtual disks should be present, please power off your system and check your cables to ensure all disks are present. Press any key to continue, or 'C' to load the configuration utility. The cache contains dirty data, but some virtual disks are missing or will go offline, so the cached data cannot be written to disk. If this is an unexpected error, then please power off your system and check your cables to ensure all disks are present. If you continue, the data in cache will be

permanently discarded. Press 'X' to acknowledge and permanently destroy the cached data.

Probable Cause: The controller preserves the dirty cache from a virtual disk if the disk becomes offline or is deleted because of missing physical disks. This message indicates that some configured disks were removed. If the disks were not removed, they are no longer accessible. The SAS cables for your system might be improperly connected.

Corrective Action: Check the cable connections and fix any problems. Restart the system. Use the <Ctrl> <R> utility to import the virtual disk or discard the preserved cache. For the steps to manage preserved cache, see [Managing The Preserved Cache](#).

BIOS disabled error message

Error Message: BIOS Disabled. No Logical Drives Handled by BIOS.

Probable Cause: This warning message is displayed after you disable the **ROM** option in the configuration utility. When the **ROM** option is disabled, the BIOS cannot boot to Int 13h and cannot provide the ability to boot from the virtual disk. Int 13h is an interrupt signal that supports numerous commands that are sent to the BIOS and then passed to the physical disk. The commands include actions you can perform with a physical disk, such as reading, writing, and formatting.

Corrective Action: Enable the **ROM** option.

Drive Configuration Changes Error Message

Error Message: Entering the configuration utility in this state will result in drive configuration changes. Press 'Y' to continue loading the configuration utility or please power off your system and check your cables to ensure all disks are present and reboot.

Probable Cause: The message is displayed after another BIOS warning indicating there are problems with previously configured disks and you have chosen to accept any changes and continue. The SAS cables for your system might be improperly connected.

Corrective Action: Check the cable connections and fix any problems before restarting the system. If there are no cable problems, press any key or <Y> to continue.

Adapter at baseport not responding error message

Error Message: Adapter at Baseport xxxx is not responding, where xxxx is the baseport of the controller.

Corrective Action: Contact Dell Technical Support.

Offline or missing virtual drives with preserved cache error message

Error Message: There are offline or missing virtual drives with preserved cache. Please check the cables and ensure that all drives are present. Press any key to enter the configuration utility.

Probable Cause: The controller preserves the dirty cache from a virtual disk if the disk becomes offline or is deleted because of missing physical disks. This preserved dirty cache is called pinned cache, and is preserved until you import the virtual disk, or discard the cache.

Corrective Action: Use the <Ctrl> <R> utility to import the virtual disk or discard the preserved cache. For the steps used to manage preserved cache, see [Managing The Preserved Cache](#).



NOTE: Ctrl R is not available for systems set to UEFI boot mode. Use the HII menu to manage preserved cache in these cases.

Virtual disks offline error message

Error Message: `x Virtual Disk(s) Degraded`, where `x` is the number of virtual disks degraded.

Probable Cause: This message is displayed when the BIOS detects virtual disks in a degraded state.

Corrective Action: Take corrective action(s) to make the virtual disks optimal. The BIOS does not take any action.

Virtual disks degraded error message

Error Message: `x Virtual Disk(s) Degraded`, where `x` is the number of virtual disks degraded.

Probable Cause: This message is displayed when the BIOS detects virtual disks in a degraded state.

Corrective Action: To make the virtual disks optimal, take one the following corrective actions:

- Ensure all disks in the Virtual Disk are present and online.
- Replace any failed disks that may be in the array.
- Correct a hot spare disk, and rebuild the array.

The BIOS does not take any action.

Virtual disks partially degraded error message

Error Message: `x Virtual Disk(s) Partially Degraded`, where `x` is the number of virtual disks partially degraded.

Probable Cause: This message is displayed when the BIOS detects a single disk failure in a RAID 6 or RAID 60 configuration.

Corrective Action: You must check why the member disk is not present to correct the problem. The BIOS does not take any action.

Memory or battery problem error message

Error Message: `Memory/Battery problems were detected. The adapter has recovered, but cached data was lost. Press any key to continue.`

Probable Cause: The message occurs under the following conditions:

- The adapter detects data in the controller cache that has not yet been written to the disk subsystem.
- The controller detects an Error-Correcting Code (ECC) error while performing its cache checking routine during initialization.
- The controller discards the cache rather than sending it to the disk subsystem because the data integrity cannot be guaranteed.
- The battery may be under charged.

Corrective Action: Allow the battery to charge fully to resolve this problem. If the problem persists, the battery or controller memory may be faulty. Contact Dell Technical Support.

Firmware fault state error message

Error Message: `Firmware is in Fault State.`

Corrective Action: Contact Dell Technical Support.

Foreign configuration found error message

Error Message: `Foreign configuration(s) found on adapter. Press any key to continue, or 'C' to load the configuration utility or 'F' to import foreign configuration(s) and continue.`

Probable Cause: When a controller firmware detects a physical disk with existing foreign metadata, it flags the physical disk as *foreign* and generates an alert indicating that a foreign disk was detected.

Corrective Action: Press <F> at this prompt to import the configuration (if all member disks of the virtual disk are present) without loading the **BIOS Configuration Utility** (<Ctrl> <R>). Or press <C> to enter the **BIOS Configuration Utility** (<Ctrl> <R>) and either import or clear the foreign configuration.

Foreign configuration not found in <ctrl> <R> error message

Error Message: `The foreign configuration message is present during POST but no foreign configurations are present in the foreign view page in <Ctrl> <R>. All virtual disks are in an optimal state.`

Corrective Action: Ensure all your PDs are present and all VDs are in optimal state. Clear the foreign configuration using <Ctrl> <R> or **Dell OpenManage Server Administrator Storage Management**.

 **CAUTION: The physical disk goes to Ready state when you clear the foreign configuration.**

If you insert a physical disk that was previously a member of a virtual disk in the system, and that disk's previous location has been taken by a replacement disk through a rebuild, you must manually remove the foreign configuration flag of the newly inserted disk.

Previous configuration cleared or missing error message

- Error Message:** Previous configuration(s) cleared or missing. Importing configuration created on XX/XX XX.XX. Press any key to continue, or 'C' to load the configuration utility.
- Probable Cause:** The message indicates that the controller and physical disks have different configurations.
- Corrective Action:** You can use the **BIOS Configuration Utility** (<Ctrl> <R>) to clear the foreign configuration.

Invalid SAS topology detected error message

- Error Message:** Invalid SAS topology detected. Please check your cable configurations, repair the problem, and restart your system.
- Probable Cause:** The SAS cables for your system are improperly connected.
- Corrective Action:** Check the cable connections and fix problems if any. Restart the system.

Configured disks removed or not accessible error message

- Error Message:** Some configured disks have been removed from your system or are no longer accessible. Check your cables and ensure all disks are present. Press any key or 'C' to continue.
- Probable Cause:** The message indicates that some configured disks were removed. If the disks were not removed, they are no longer accessible. The SAS cables for your system might be improperly connected.
- Corrective Action:** Check the cable connections and fix issues if any. Restart the system. If there are no cable problems, press any key or <C> to continue.

Degraded state of virtual disks

A redundant virtual disk is in a degraded state when one or more physical disks have failed or are inaccessible. For example, if a RAID 1 virtual disk consists of two physical disks and one of them fails or become inaccessible, the virtual disk become degraded.

To recover a virtual disk from a degraded state, you must replace the failed physical disk and rebuild it. Once the rebuilding process is complete, the virtual disk state changes from degraded to optimal. For information on rebuilding the disk, see [Performing A Manual Rebuild Of An Individual Physical Disk](#).

Memory errors

Memory errors can corrupt cached data, so the controllers are designed to detect and attempt to recover from the memory errors. Single-bit memory errors can be handled by the controller and do not disrupt normal operation. A notification is sent if the number of single-bit errors exceeds a threshold value.

Multi-bit errors are more serious as they result in corrupted data and data loss. The following are the actions that occur in the case of multi-bit errors:

- If a multi-bit error occurs while accessing data in the cache when the controller is started with dirty cache, the controller discards the cache contents. The controller generates a warning message to the system console to indicate that the cache was discarded and generates an event.
- If a multi-bit error occurs at run-time either in code/data or in the cache, the controller stops.
- The controller logs an event to the controller's internal event log and a message during POST is displayed indicating a multi-bit error has occurred.

 **NOTE:** In case of a multi-bit error, contact Dell Technical Support.

Preserved Cache State

The controller preserves the dirty cache from a virtual disk if the virtual disk becomes offline or is deleted because of missing physical disks. This preserved dirty cache is called pinned cache and is preserved until you import the virtual disk or discard the cache.

Use the **BIOS Configuration Utility** (<Ctrl> <R>) to select whether to import the virtual disk or discard the preserved cache. In the **VD Mgmt** menu, select **Manage Preserved Cache** and follow the steps on the screen.

Security key errors

Secured foreign import errors

A foreign configuration is a RAID configuration that already exists on a replacement physical disk that you install in a system. A secured foreign configuration is a RAID configuration that was created under a different security key.

There are two scenarios in which a secured foreign import fails:

- **The passphrase authentication fails**—A virtual disk secured with a security key different from the current controller security key cannot be imported without authentication of the original passphrase used to secure them. Supply the correct passphrase to import the secured foreign configuration. If you have lost or forgotten the passphrase, the secured foreign disks remain locked (inaccessible) until the appropriate passphrase is entered or if they are instant secure erased.
- **The secured virtual disk is in an offline state after supplying the correct passphrase**—You must check to determine why the virtual disk failed and correct the problem.

Failure to select or configure non Self-Encrypting Disks (non-SED)

A virtual disk can be either secured or unsecured depending on how it was configured when created. In order to create a secured virtual disk, the controller must have a security key present and must contain SEDs only. In order to select/configure non-SED, you must create an unsecured virtual disk. You can create an unsecured virtual disk even if there is a security key. Select the **Secure VD** option as **No** in the **Create New VD** menu. For steps on how to create an unsecured virtual disk, see [Creating virtual disks](#).

Failure to delete security key

A security key is used to lock or unlock access to a security-enabled component. This key is not utilized in the actual encryption of data. If a security key is present, both secured and unsecured virtual disks may exist.

To delete the security key, you must have a previously established security key present on the controller and there cannot be any configured secured disks. If there are configured secured disks, remove or delete them.

Failure to instant secure erase task on physical disks

Instant Secure Erase is the process of securely erasing all data permanently on an encryption-capable physical disk and resetting the security attributes. It is used in a couple of scenarios such as deleting a foreign configuration in the event of a forgotten or lost passphrase or unlocking a disk that had been previously locked.

Instant Secure Erase can be executed only on encryption-capable disks as long as the disks are not hot spares and are not configured (part of a virtual disk). Ensure that the conditions are met and see [Instant Secure Erase](#).

General issues

PERC card has yellow bang in device manager

Issue: The device is displayed in **Device Manager** but has a yellow bang (exclamation mark).

Corrective Action: Reinstall the driver. For more information on reinstalling drivers, see [Driver installation](#).

PERC card not seen in device manager

Issue: The device does not appear in the **Device Manager**.

Corrective Action: Turn off the system and reseal the controller.
For more information, see [Installing The PERC 9 Card](#).

Physical disk issues

Physical disk in failed state

Issue: One of the physical disks in the disk array is in the failed state.

Corrective Action: Update the PERC cards to the latest firmware available on dell.com/support.

Unable to rebuild a fault tolerant virtual disk

Issue: Cannot rebuild a fault tolerant virtual disk. For more information, see the alert log for virtual disks.

Corrective Action: The replacement disk is too small or not compatible with the virtual disk. Replace the failed disk with a compatible good physical disk with equal or greater capacity.

Fatal error or data corruption reported

Issue: Fatal error(s) or data corruption(s) are reported when accessing virtual disks.

Corrective Action: Contact Dell Technical Support.

Physical disk displayed as blocked

Issue: One or more physical disks is displayed as **Blocked** and cannot be configured.

Corrective Action: Update the PERC cards to the latest firmware available on dell.com/support.

Multiple disks become inaccessible

Issue: Rebuilding the physical disks after multiple disks become simultaneously inaccessible.

Corrective Action: Multiple physical disk errors in a single array typically indicate a failure in cabling or connection and could involve the loss of data. You can recover the virtual disk after multiple physical disks become simultaneously inaccessible. Perform the following steps to recover the virtual disk:

 **CAUTION: Follow the safety precautions to prevent electrostatic discharge.**

1. Turn off the system, check cable connections, and reseal physical disks.
2. Ensure that all the disks are present in the enclosure.
3. Turn on the system and enter the **BIOS Configuration Utility** (<Ctrl> <R>) utility.
4. Import the foreign configuration.
5. Press <F> at the prompt to import the configuration, or press <C> to enter the **BIOS Configuration Utility** (<Ctrl> <R>) and either import or clear the foreign configuration.

If the virtual disk is redundant and transitioned to **Degraded** state before going **Offline**, a rebuild operation starts automatically after the configuration is imported. If the virtual disk has gone directly to the **Offline** state due to a cable pull or power loss situation, the virtual disk is imported in its **Optimal** state without a rebuild occurring.

 **NOTE:** You can use the **BIOS Configuration Utility** (<Ctrl> <R>) or Dell OpenManage storage management application to perform a manual rebuild of multiple physical disks. For information on rebuilding a single physical disk, see [Performing A Manual Rebuild Of An Individual Physical Disk](#).

Rebuilding a failed physical disk

Issue: Rebuilding a physical disk that is in a failed state.

Corrective Action: If you have configured hot spares, the PERC card automatically tries to use one of the hot spares to rebuild a physical disk that is in a failed state. Manual rebuild is necessary if no hot spares with enough capacity to rebuild the failed physical disks are available. You must insert a physical disk with enough storage in the subsystem before rebuilding the physical disk.

 **NOTE:** You can use the **BIOS Configuration Utility** (<Ctrl> <R>) or Dell OpenManage storage management application to perform a manual rebuild of an individual physical disk. For information on rebuilding a single physical disk, see [Performing A Manual Rebuild Of An Individual Physical Disk](#).

Virtual disk fails during rebuild using a global hot spare

Issue: A virtual disk fails during rebuild while using a global hot spare.

Description: The global hot spare reverts to **Hotspare** state and the virtual disk is in **Failed** state.

Virtual disk fails during rebuild using a dedicated hot spare

Issue: A virtual disk fails during rebuild while using a dedicated hot spare.

Description: The dedicated hot spare reverts to **Ready** state and the virtual disk goes to **Failed** state.

Physical disk fails during reconstruction on redundant virtual disk

Issue: A physical disk fails during a reconstruction process on a redundant virtual disk that has a hot spare.

Corrective Action: The dedicated hot spare reverts to **Ready** state and the virtual disk goes to **Failed** state.

Virtual disk fails rebuild using a dedicated hot spare

Issue: A virtual disk fails during rebuild while using a dedicated hot spare.

Description: The dedicated hot spare is in **Ready** state and the virtual disk is in **Failed** state.

Physical disk takes a long time to rebuild

Issue: A physical disk is taking longer than expected to rebuild.

Description: A physical disk takes longer to rebuild when under high stress. There is only one rebuild I/O operation for every five host I/O operations.

Corrective Action: If possible, reduce stress on the physical disk.

SMART errors



SMART monitors the internal performance of all motors, heads, and physical disk electronics and detects predictable physical disk failures.

 **NOTE:** For information about where to find reports of SMART errors that could indicate hardware failure, see the Dell OpenManage storage management documentation at dell.com/support/manuals.

Smart error detected on a physical disk in a redundant virtual disk

Issue: A SMART error is detected on a physical disk in a redundant virtual disk.

Corrective Action: Perform the following steps:

1. Back up your data.
2. Force the physical disk offline.
 **NOTE:** If a hot spare is present, the rebuild starts with the hot spare after the disk is forced offline.
3. Replace the disk with a new physical disk of equal or higher capacity.
4. Perform the **Replace Member** operation.
 **NOTE:** The **Replace Member** operation allows you to copy data from a source physical disk of a virtual disk to a target physical disk that is not a part of the virtual disk. For more information about the **Replace Member** feature, see the topic [Using Replace Member And Reversible Hot Spares](#).

Smart error detected on a physical disk in a non-redundant virtual disk

Issue: A SMART error is detected on a physical disk in a redundant virtual disk.

Corrective Action: Perform the following steps:

1. Back up your data.
2. Use **Replace Member** or set up a global hot spare to replace the disk automatically.
 **NOTE:** For more information about the **Replace Member** feature, see the topic [Using Replace Member And Reversible Hot Spares](#).
3. Replace the affected physical disk with a new physical disk of equal or higher capacity.
4. Restore from the backup.

Replace member errors

 **NOTE:** For more information about the **Replace Member** features, see [Using Replace Member And Reversible Hot Spares](#).

Source disk fails during replace member operation

Issue: The source disk fails during the **Replace Member** operation.

Corrective Action: If the source data is available from other disks in the virtual disk, the rebuild begins automatically on the target disk, using the data from the other disks.

Target disk fails

Issue: The target disk fails.

Corrective Action: If the target disk fails, the **Replace Member** operation aborts.

General disk fails

Issue: A general disk fails.

Corrective Action: If the target disk fails and the **Replace Member** operation aborts but the source data is still available, then the **Replace Member** operation continues as **Replace Member**.

Linux operating system errors

Virtual disk policy is assumed as write-through error message

Error: `<Date:Time> <HostName> kernel: sdb: asking for cache data failed<Date:Time> <HostName> kernel: sdb: assuming drive cache: write through`

Corrective Action: The error message is displayed when the Linux Small Computer System Interface (SCSI) mid-layer asks for physical disk cache settings. The controller firmware manages the virtual disk cache settings on a per controller and a per virtual disk basis, so the firmware does not respond to this command. The Linux SCSI mid-layer assumes that the virtual disk's cache policy is **Write-Through**. SDB is the device node for a virtual disk. This value changes for each virtual disk. For more information about **Write-Through** cache, see [Virtual Disk Write Cache Policies](#).

Except for this message, there is no effect of this behavior on normal operation. The cache policy of the virtual disk and the I/O throughput are not affected by this message. The cache policy settings for the PERC SAS RAID system remain unchanged.

Unable to register SCSI device error message

Error: `smartd[smartd[2338] Device: /dev/sda, Bad IEC (SMART) mode page, err=-5, skip device smartd[2338] Unable to register SCSI device /dev/sda at line 1 of file /etc/smartd.conf.`

Corrective Action: This is a known issue. An unsupported command is entered through the user application. User applications attempt to direct Command Descriptor Blocks to RAID volumes. The error message does not affect the feature functionality. The **Mode Sense/Select** command is supported by firmware on the controller. However, the Linux kernel **daemon** issues the command to the virtual disk instead of to the driver **IOCTL** node. This action is not supported.

Disk Carrier LED Indicators

The LED on the physical disk carrier indicates the state of each physical disk. Each disk carrier in your enclosure has two LEDs: an activity LED (green) and a status LED (bicolor, green/amber). The activity LED is active whenever a disk is being accessed while the status LED indicates when a disk is being spun up, is rebuilding, or is in a fault state.

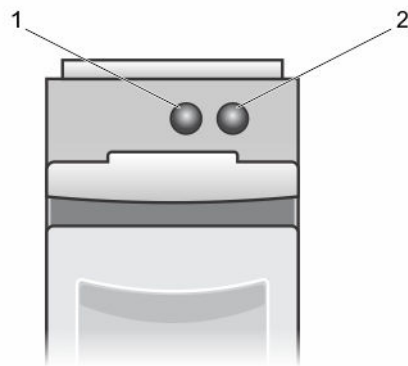

Figure 21. Disk Carrier LED Indicators

1. activity LED
2. status LED

UEFI error messages

Unhealthy Status of the Drivers

Error: One or more boot driver(s) have reported issues. Check the Driver Health Menu in Boot Manager for details.

Probable Cause: This message might indicate that the cables are not connected, the disks might be missing, or the UEFI driver might require configuration changes.

Corrective Action:

1. Check if the cables are connected properly, or replace missing hard drives, if any and then restart the system.
2. Press any key to load the driver health manager to display the configurations. The Driver Health Manager displays the driver(s), which requires configuration.

3. Alternately, if the UEFI driver requires configuration, press any key to load the Configuration Utility.

Appendix: RAID description

RAID is a group of independent physical disks that provides high performance by increasing the number of disks used for saving and accessing data.

 **CAUTION: In the event of a physical disk failure, a RAID 0 virtual disk fails, resulting in data loss.**

A RAID disk subsystem offers the following benefits:

- Improved I/O performance and data availability.
- Improved data throughput because several disks are accessed simultaneously. The physical disk group appears either as a single storage unit or multiple logical units to the host system.
- Improved data storage availability and fault tolerance. Data loss caused by a physical disk failure can be recovered by rebuilding missing data from the remaining physical disks containing data or parity.

Summary of RAID levels

Following is the RAID levels supported by PERC 9 series of cards:

- RAID 0 uses disk striping to provide high data throughput, especially for large files in an environment that requires no data redundancy.
- RAID 1 uses disk mirroring so that data written to one physical disk is simultaneously written to another physical disk. RAID 1 is good for small databases or other applications that require small capacity and complete data redundancy.
- RAID 5 uses disk striping and parity data across all physical disks (distributed parity) to provide high data throughput and data redundancy, especially for small random access.
- RAID 6 is an extension of RAID 5 and uses an additional parity block. RAID 6 uses block-level striping with two parity blocks distributed across all member disks. RAID 6 provides protection against double disk failures, and failures while a single disk is rebuilding. If you are using only one array, deploying RAID 6 is more effective than deploying a hot spare disk.
- RAID 10 is a combination of RAID 0 and RAID 1, uses disk striping across mirrored disks. It provides high data throughput and complete data redundancy.
- RAID 50 is a combination of RAID 0 and RAID 5 where a RAID 0 array is striped across RAID 5 elements. RAID 50 requires at least six disks.
- RAID 60 is a combination of RAID 0 and RAID 6 where a RAID 0 array is striped across RAID 6 elements. RAID 60 requires at least eight disks.

RAID terminology

Disk striping

Disk striping allows you to write data across multiple physical disks instead of just one physical disk. Disk striping involves partitioning each physical disk storage space in stripes of the following sizes: 64 KB, 128

KB, 256 KB, 512 KB, and 1 MB. The stripes are interleaved in a repeated sequential manner. The part of the stripe on a single physical disk is called a stripe element.

For example, in a four-disk system using only disk striping (used in RAID 0), segment 1 is written to disk 1, segment 2 is written to disk 2, and so on. Disk striping enhances performance because multiple physical disks are accessed simultaneously, but disk striping does not provide data redundancy.

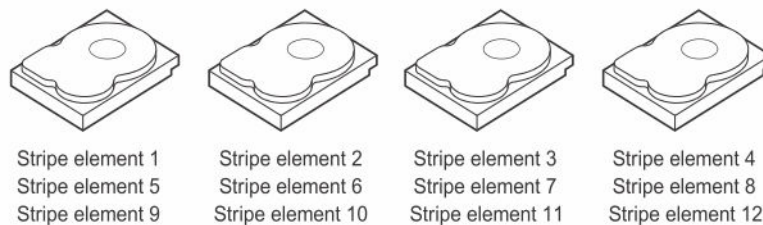

Figure 22. Example of disk striping (RAID 0)

Disk mirroring

With mirroring (used in RAID 1), data written to one disk is simultaneously written to another disk. If one disk fails, the contents of the other disk can be used to run the system and rebuild the failed physical disk. The primary advantage of disk mirroring is that it provides complete data redundancy. Both disks contain the same data at all times. Either of the physical disks can act as the operational physical disk.

Disk mirroring provides complete redundancy, but is an expensive option because each physical disk in the system must be duplicated.

 **NOTE:** Mirrored physical disks improve read performance by read load balance.

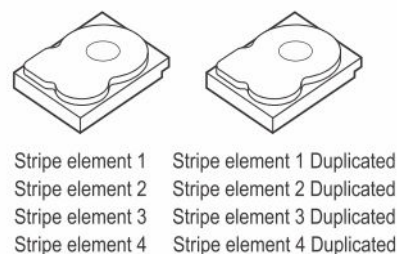

Figure 23. Example of Disk Mirroring (RAID 1)

Spanned RAID levels

Spanning is a term used to describe the way in which RAID levels 10, 50, and 60 are constructed from multiple sets of basic, or simple RAID levels. For example, a RAID 10 has multiple sets of RAID 1 arrays where each RAID 1 set is considered a span. Data is then striped (RAID 0) across the RAID 1 spans to create a RAID 10 virtual disk. Similarly, RAID 50 and RAID 60 combine multiple sets of RAID 5 or RAID 6 respectively with striping.

Parity data

Parity data is redundant data that is generated to provide fault tolerance within certain RAID levels. In the event of a disk failure, the parity data can be used by the controller to regenerate user data. Parity data is present for RAID 5, 6, 50, and 60.

The parity data is distributed across all the physical disks in the system. If a single physical disk fails, it can be rebuilt from the parity and the data on the remaining physical disks. RAID level 5 combines distributed parity with disk striping. Parity provides redundancy for one physical disk failure without duplicating the contents of the entire physical disks.

RAID 6 combines dual distributed parity with disk striping. This level of parity allows for two disk failures without duplicating the contents of entire physical disks.

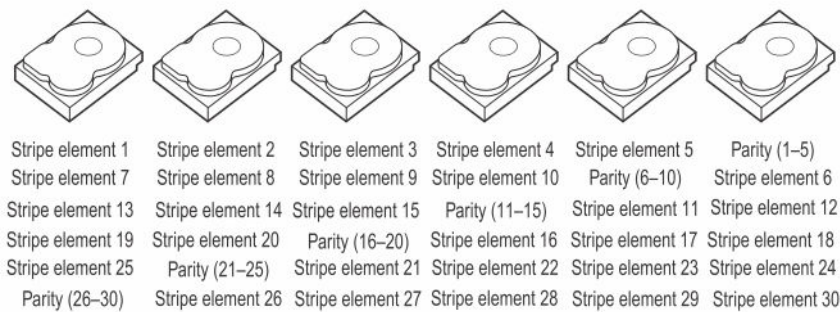



Figure 24. Example of Distributed Parity (RAID 5)

 **NOTE:** Parity is distributed across multiple physical disks in the disk group.

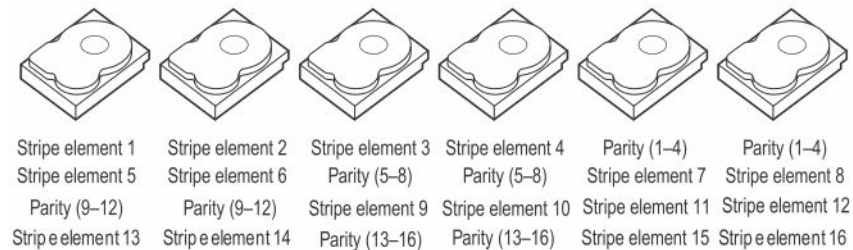

Figure 25. Example of Dual Distributed Parity (RAID 6)

 **NOTE:** Parity is distributed across all disks in the array.

Getting help

You can get help with your Dell product by contacting Dell, or send feedback on product documentation.

Contacting Dell

Dell provides several online and telephone-based support and service options. If you do not have an active internet connection, you can find contact information on your purchase invoice, packing slip, bill, or Dell product catalog. Availability varies by country and product, and some services may not be available in your area. To contact Dell for sales, technical assistance, or customer-service issues:

1. Go to **Dell.com/support**.
2. Select your country from the drop-down menu on the bottom right corner of the page.
3. For customized support:
 - a. Enter your system Service Tag in the **Enter your Service Tag** field.
 - b. Click **Submit**.
The support page that lists the various support categories is displayed.
4. For general support:
 - a. Select your product category.
 - b. Select your product segment.
 - c. Select your product.
The support page that lists the various support categories is displayed.

Documentation feedback

Click the **Feedback** link in any of the Dell documentation pages, fill out the form, and click **Submit** to send your feedback.

Locating Service Tag of your system

Your system is identified by a unique Express Service Code and Service Tag number. The Express Service Code and Service Tag are found on the front of the system by pulling out the information tag . Alternatively, the information may be on a sticker on the chassis of the system. This information is used by Dell to route support calls to the appropriate personnel.

Your system is identified by a unique Express Service Code and Service Tag number. The Express Service Code and Service Tag are found on the chassis label. Alternatively, the information may be on a sticker on the chassis of the system. This information is used by Dell to route support calls to the appropriate personnel.