

UPSe

Installation and operating instructions



UPSe

English (US)

Installation and operating instructions	4
---	---

Original installation and operating instructions

Table of contents

1. Limited warranty	4
2. General information	5
2.1 Hazard statements	5
2.2 Notes	5
3. Product introduction.	5
3.1 Product description	5
3.2 Intended use	5
3.3 Pumped liquids	6
3.4 Identification	6
3.5 Approvals	7
4. Receiving the product.	7
4.1 Inspecting the product	7
4.2 Scope of delivery	7
5. Installation requirements	8
5.1 Optimal installation and operation	8
6. Mechanical installation	8
6.1 Mounting the product	8
6.2 Changing the control box position	9
7. Electrical connection	11
7.1 Wiring the pump	11
8. Starting up the product	12
8.1 Venting the pump	12
8.2 Dry-running protection	12
9. Control functions	13
9.1 Operating panel, UPSe	13
9.2 Light fields indication	13
9.3 Control modes	14
10. Setting the product.	15
10.1 Settings according to system type	15
11. Service	16
11.1 Dismantling the product	17
12. Fault finding	17
12.1 Fault indication on the pump operating panel	18
12.2 Dry running	18
12.3 Blocked pump	18
12.4 Undervoltage	18
12.5 Electrical fault	18
12.6 Electrical fault	18
12.7 Overheated boiler	18
12.8 Noise in the system	18
13. Technical data	19
14. Disposing of the product	19
15. Document quality feedback	19

1. Limited warranty

Products manufactured by Grundfos Pumps Corporation (Grundfos) are warranted to the original user only to be free of defects in material and workmanship for a period of 24 months from date of installation, but not more than 30 months from date of manufacture. Grundfos' liability under this warranty shall be limited to repairing or replacing at Grundfos' option, without charge, F.O.B. Grundfos' factory or authorized service station, any product of Grundfos manufacture. Grundfos will not be liable for any costs of removal, installation, transportation, or any other charges that may arise in connection with a warranty claim. Products which are sold, but not manufactured by Grundfos, are subject to the warranty provided by the manufacturer of said products and not by Grundfos' warranty. Grundfos will not be liable for damage or wear to products caused by abnormal operating conditions, accident, abuse, misuse, unauthorized alteration or repair, or if the product was not installed in accordance with Grundfos' printed installation and operating instructions and accepted codes of good practice. The warranty does not cover normal wear and tear. To obtain service under this warranty, the defective product must be returned to the distributor or dealer of Grundfos' products from which it was purchased together with proof of purchase and installation date, failure date and supporting installation data. Unless otherwise provided, the distributor or dealer will contact Grundfos or an authorized service station for instructions. Any defective product to be returned to Grundfos or a service station must be sent freight prepaid; documentation supporting the warranty claim and/or a Return Material Authorization must be included if so instructed. Grundfos will not be liable for any incidental or consequential damages, losses, or expenses arising from installation, use, or any other causes. There are no express or implied warranties, including merchantability or fitness for a particular purpose, which extend beyond those warranties described or referred to above. Some jurisdictions do not allow the exclusion or limitation of incidental or consequential damages and some jurisdictions do not allow limitations on how long implied warranties may last. Therefore, the above limitations or exclusions may not apply to you. This warranty gives you specific legal rights and you may also have other rights which vary from jurisdiction to jurisdiction. Products which are repaired or replaced by Grundfos or authorized service center under the provisions of these limited warranty terms will continue to be covered by Grundfos warranty only through the remainder of the original warranty period set forth by the original purchase date.

2. General information



Read this document before you install the product. Installation and operation must comply with local regulations and accepted codes of good practice.

2.1 Hazard statements

The symbols and hazard statements below may appear in Grundfos installation and operating instructions, safety instructions and service instructions.



DANGER

Indicates a hazardous situation which, if not avoided, will result in death or serious personal injury.



WARNING

Indicates a hazardous situation which, if not avoided, could result in death or serious personal injury.



CAUTION

Indicates a hazardous situation which, if not avoided, could result in minor or moderate personal injury.

The hazard statements are structured in the following way:



SIGNAL WORD

Description of the hazard

Consequence of ignoring the warning

- Action to avoid the hazard.

2.2 Notes

The symbols and notes below may appear in Grundfos installation and operating instructions, safety instructions and service instructions.



Observe these instructions for explosion-proof products.



A blue or gray circle with a white graphical symbol indicates that an action must be taken.



A red or gray circle with a diagonal bar, possibly with a black graphical symbol, indicates that an action must not be taken or must be stopped.



If these instructions are not observed, it may result in malfunction or damage to the equipment.



Tips and advice that make the work easier.

3. Product introduction

3.1 Product description



TM083137

UPSe

UPSe is a high-efficiency circulator fitted with an electronically commutated motor. It has been designed for circulating liquids in heating systems and offers the highest energy savings on the market.

The pump features a wide range of controls, featuring constant-pressure, proportional-pressure and constant-speed curve, each with three settings, making it suitable for almost any heating application. With the use of the Grundfos GO replacement compatibility check, it is easier than ever to make your selection.

The new toolless, removeable power connector results in fast and easy installation. Fewer callbacks can be expected due to its robust startup, self-venting ability and dry-running protection. Fault finding is also fast and easy by using error codes on the pump user interface.

A terminal box with conduit connections is provided for power connection.

3.2 Intended use

The pump is designed for circulating liquids in heating and air conditioning systems.

3.3 Pumped liquids

WARNING

Electric shock

Death or serious personal injury

- For indoor use only.
- This pump has not been investigated for use in swimming pool or marine areas.



WARNING

Fire or explosion hazard

Death or serious personal injury

- The pump must not be used for the transfer of flammable liquids such as diesel oil, gasoline and similar liquids.



The product is suitable for pumping clean, thin, non-aggressive and non-explosive liquids without solid particles or fibers or mineral oils. If required, 50 % of the volume solution of glycol and water can be used. However, a decrease in pump performance may occur due to an increase in the viscosity of the solution. Contact the manufacturer for information regarding suitability of the pump for pumping other liquids.

The pump is designed to circulate water from 36 to 230 °F (2 to 110 °C) up to a maximum pressure of 175 psi (12 bar), depending on the variant.

3.4 Identification

3.4.1 Nameplate

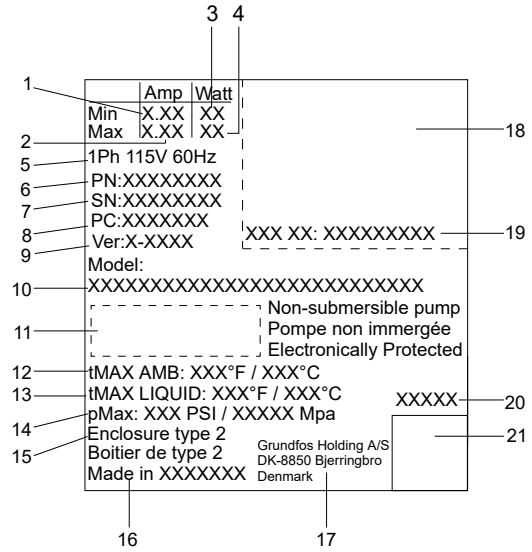

TM062374

Pos.	Description
1	Min. current consumption
2	Max. current consumption
3	Min. power consumption
4	Max. power consumption
5	Number of phases, voltage and frequency
6	Product number
7	Serial number
8	Factory code and production code (year and week)
9	Version letter and update number
10	Pump model
11	Enclosure class
12	Max. ambient temperature
13	Max. liquid temperature
14	Max. system pressure
15	Enclosure type
16	Country of origin
17	Grundfos address
18	Approvals
19	FCC radio approval ID
20	Combined legal product code
21	Data matrix

Related information

- [4.1 Inspecting the product](#)
- [7. Electrical connection](#)

3.4.2 Type key

Example: UPSe 15-58 FR

Code	Explanation	Designation
UPSe	Grundfos circulator	Pump type
15	Small circulators	
58	Maximum head [dm]	
F	Flange	Pipe connection
FR	Flange rotated	

3.5 Approvals



TM057110



TM073284



This equipment has been tested and found to comply with the limits for a class B digital device, pursuant to Part 15 of the FCC Rules.



Any changes or modifications to this equipment not expressly approved by the party responsible for compliance could void the user's authority to operate this equipment.

These limits are designed to provide reasonable protection against harmful interference in a residential installation. This equipment generates, uses and can radiate radio frequency energy and, if not installed and used in accordance with the instructions, may cause harmful interference to radio communications. However, there is no guarantee that interference will not occur in a particular installation. If this equipment does cause harmful interference to radio or television reception, which can be determined by turning the equipment off and on, the user is encouraged to try to correct the interference by one or more of the following measures:

- Reorient or relocate the receiving antenna.
- Increase the separation between the equipment and receiver.
- Connect the equipment to an outlet on a circuit different from that to which the receiver is connected.
- Consult the dealer or an experienced radio/TV technician for help.

4. Receiving the product

4.1 Inspecting the product



CAUTION

Crushing of feet

Minor or moderate personal injury
- Wear safety shoes when handling the product.



CAUTION

Sharp element

Minor or moderate personal injury
- Wear protective gloves.

1. Make sure that the delivered product corresponds to the order.
2. Make sure that the voltage and frequency of the product match the voltage and frequency of the installation site.

Related information

[3.4.1 Nameplate](#)

4.2 Scope of delivery

The box contains the following items:

- 1 pump
- 1 power connector
- 2 screws for the conduit box
- 1 check valve
- 1 blanking plug
- 2 gaskets
- 1 quick guide
- 1 safety instructions booklet.

5. Installation requirements

5.1 Optimal installation and operation

See below for information about the installation and setting of the product:

- Slow down the flow to dissipate the heat in the zones faster.
- A small temperature difference between the inlet and outlet of the boiler can cause inefficient boiler performance and in some cases short cycling. Lowering the flow of the circulator can prevent this from happening.
- By having a larger delta T going back to the boiler, the boiler eventually starts to condense. The efficiency of the boiler and system increases, thereby saving money and wear and tear on your system.
- In order to create a flow in a system, the pump needs to neutralize the system head loss before it can create a flow in the system.
- In case there is too little heat at the far end of the installation, choose a higher setting on the pump or check the hydronic balance of the system. An increase in the boiler supply temperature could also be a solution.
- When mounting the pump, ensure that the shaft is in a horizontal position to avoid air being trapped inside or bearings being worn out too quickly.
- Make sure that you have the proper voltage and that the wires are connected properly (black = phase, white = neutral, green or bare copper = ground).

Related information

[6.1 Mounting the product](#)

[7.1 Wiring the pump](#)

6. Mechanical installation

WARNING

Electric shock

Death or serious personal injury

- A damaged product must be repaired or replaced by Grundfos or a service workshop authorized by Grundfos.



CAUTION

Crushing of feet

Minor or moderate personal injury

- Wear safety shoes when opening the box and handling the product.



CAUTION

Sharp element

Minor or moderate personal injury

- Wear protective gloves.



The pump must always be installed with a horizontal motor shaft within $\pm 5^\circ$.



The pump is a non-submersible pump.

6.1 Mounting the product

The arrows on the pump housing indicate the flow direction through the pump. See the figure below.

Note that for certain housings, a check valve can be fitted in the outlet.

1. Fit the two gaskets supplied, if applicable, with the pump when you mount the pump in the pipe.



TM082452

2. Install the pump with a horizontal motor shaft within $\pm 5^\circ$.

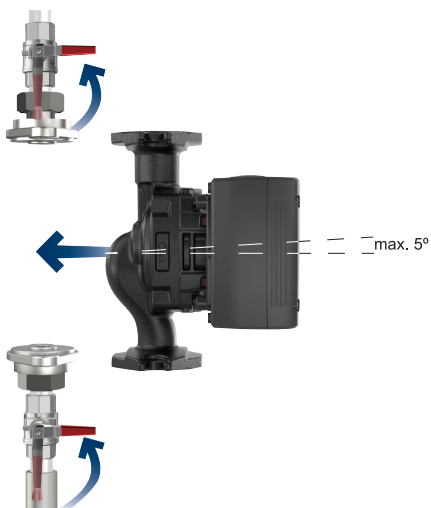

TM082453

3. Tighten the fittings or flange bolts. (what torque for flange and what for union)



TM082454

Related information

[5.1 Optimal installation and operation](#)

6.2 Changing the control box position

CAUTION

Hot surface

Minor or moderate personal injury

- Position the pump so that persons cannot accidentally come into contact with hot surfaces.

WARNING

Pressurized system

Minor or moderate personal injury

- Before dismantling the pump, drain the system or close the isolating valves on both sides of the pump. The pumped liquid may be scalding hot and under high pressure.



Make sure that the isolating valves are closed before rotating the control box. The pump must be pressureless before the control box is rotated. Drain the system or relieve the pressure inside the pump housing.

To change the position of the control box, do as follows:

1. Loosen and remove the four screws.



TM082508

3. Insert and cross-tighten the screws.



TM082510

2. Turn the pump head to the desired position.



TM082509

You can turn the control box in steps of 90° if the flanges are in standard position (F) and in steps of 180° if the flanges are in flange rotated position (FR).

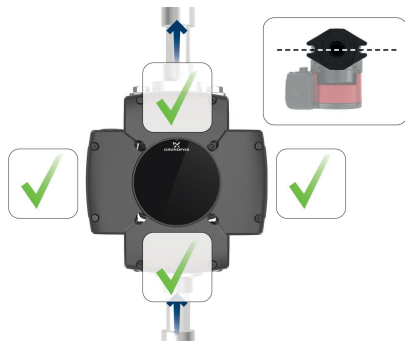

TM082458

Flanges in standard position (F)

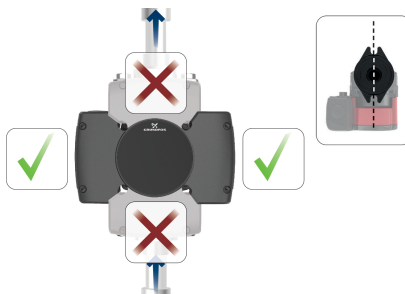

TM082457

Flanges in flange rotated position (FR)

7. Electrical connection

WARNING

Electric shock

Death or serious personal injury



- Switch off the power supply before you start any work on the product. Make sure that the power supply cannot be switched on accidentally.

WARNING

Electric shock

Death or serious personal injury



- Connect the product only to a properly grounded receptacle.

WARNING

Electric shock

Death or serious personal injury



- All electrical connections must be carried out by a qualified electrician in accordance with local regulations.

WARNING

Electric shock

Death or serious personal injury



- Use of the product on a circuit equipment with a GFCI can cause improper operation of the GFCI. Consult an electrician and observe all national, state and local electrical regulations, as applicable.

- The pump is electronically protected and therefore requires no external motor protection.
- Check that the supply voltage and frequency correspond to the values stated on the nameplate.
- Connect the pump to the power supply with the power connector supplied with the pump.

Related information

[3.4.1 Nameplate](#)

7.1 Wiring the pump

Note that the conduit connector and conduit are not supplied by Grundfos.

Follow the steps below to wire the pump:

1. Remove the lid from the conduit box, attach the conduit connector to the knockout opening and tighten the connector nut.



Use only a flexible conduit.

2. Take the power connector and lift the orange levers, and connect the black wire to L (phase), the white wire to N (neutral), and the green wire to  (ground).



The power connector can be fitted with AWG 20 - AWG 12 wires.

3. Press the orange levers down to tighten the wires.
4. Insert the power connector.
5. Mount the cover on the conduit box.

Related information

[5.1 Optimal installation and operation](#)

[11.1.1 Disconnecting the wires](#)

TM082786

8. Starting up the product

- Fill the system with liquid and vent it.
- Make sure the required minimum inlet pressure is available at the pump inlet.
- Switch on the power supply.

8.1 Venting the pump

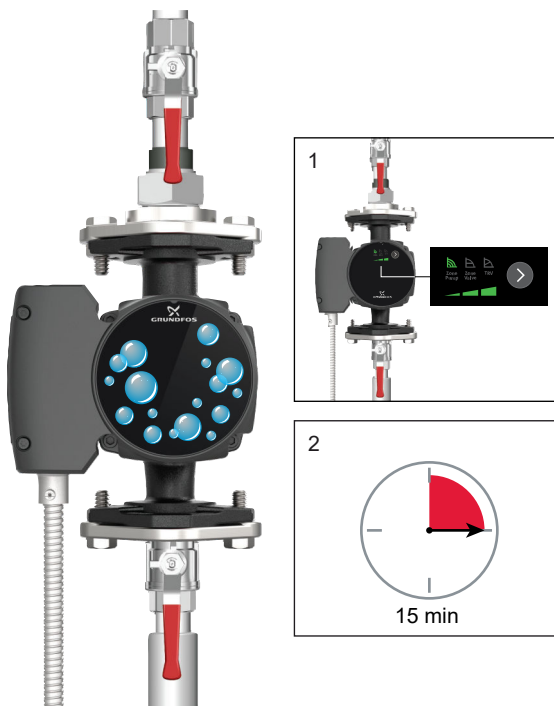

Venting the pump

Small air pockets trapped inside the pump may cause noise when starting up the pump. However, because the pump is self-venting through the system, the noise ceases over a period of time. Still, we recommend venting the pump in new installations or when the pipes have been emptied and refilled with water.

1. Set the control mode to zone pump, setting III.
2. Let the pump run for 15 minutes.



The pump must not run dry.
You cannot vent the system through the pump.

8.2 Dry-running protection

The dry-running protection protects the pump against dry running during startup and normal operation.

During startup

If water has not been detected before, the pump rotates the impeller back and forward. If water is still not detected, it retries after 30 seconds.

The pump stops after maximum 30 attempts, and the warning and alarm symbol on the display is flashing red four times.

During normal operation

If dry running is detected during normal operation, the pump stops for 30 minutes and retries. After 144 attempts the pump will stop in alarm mode.

The pump can be restarted by pressing the button on the pump. The pump will not detect dry running if dry running has been detected during the past 25 hours. If the pump has previously detected water, the pump can sustain 25 hours of dry-running operation.

Related information

[12.2 Dry running](#)

TM082507

9. Control functions

9.1 Operating panel, UPSe

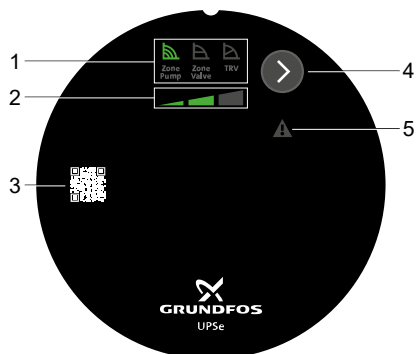

Operating panel

Pos.	Description
1	Control mode
2	Setting (I, II, III)
3	QR code When scanning the QR code, you get access to additional product information and documentation.
4	Button for changing control mode and setting
5	Warning and alarm symbol

The operating panel offers quick access to change the control mode.

The menu includes three control modes each with three pump settings:

- Constant curve (zone pump)
- Constant pressure (zone valve)
- Proportional pressure (thermostatic radiator valve (TRV)).

Related information

[9.3.1 Constant curve \(zone pump\)](#)

[9.3.2 Constant pressure \(zone valve\)](#)

[9.3.3 Proportional pressure \(thermostatic radiator valve \(TRV\)\)](#)

9.2 Light fields indication

The LEDs indicate the control mode and setting.

Factory setting

The pump is factory set to Zone pump, setting III.

Active light fields	Description
	Zone pump (constant curve)
	Zone valve (constant pressure)
	TRV (thermostatic radiator valve) (proportional pressure)
	Setting I
	Setting II
	Setting III
	Fault indication (warning = yellow / alarm = red) If the alarm indication is on, the pump is stopped.

TM082448

9.3 Control modes

9.3.1 Constant curve (zone pump)

In the constant-curve (zone pump) mode, the pump runs at a constant curve, which means that it runs at constant speed or power. The pump performance follows the selected constant curve. This control mode is especially suitable in applications where the characteristics of the heating system are steady, and the emitters require a constant flow. The selection of the constant-curve setting depends on the characteristics of the heating system and the actual required flow and heat demand.

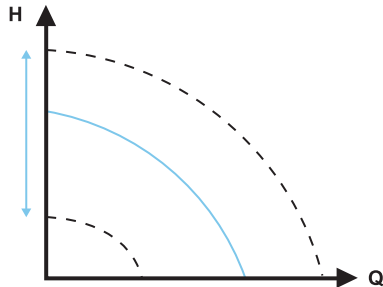

Constant curve

Related information

[9.1 Operating panel, UPSe](#)

[10.1 Settings according to system type](#)

9.3.2 Constant pressure (zone valve)

In the constant-pressure (zone valve) mode the pump runs at constant pressure which means the head (pressure difference) is kept constant, irrespective of the actual number of opened zones. The pump performance follows the selected constant-pressure curve. This control mode is especially suitable for underfloor heating and applications where the pump is used to supply a common header for multiple zone valves. The head across each zone will remain constant independent of how many zones request heat, thus a constant flow in each zone will be maintained, independent of other zones. The selection of the constant-pressure setting depends on the characteristics of the zones in the heating system and the actual heat demand.

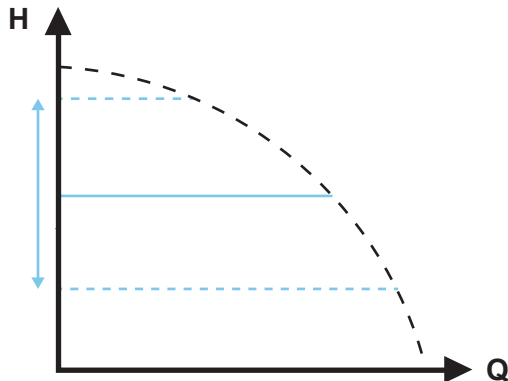

Constant pressure

Related information

[9.1 Operating panel, UPSe](#)

[10.1 Settings according to system type](#)

9.3.3 Proportional pressure (thermostatic radiator valve (TRV))

In the proportional-pressure (thermostatic radiator valve (TRV)) mode, the pump runs at proportional pressure, which means the head (pressure) is reduced at falling heat demand and increased at rising heat demand. The pump performance follows the selected proportional-pressure curve. This control mode is especially

suitable for applications where the heat emitters are equipped with a TRV which controls the flow depending on the room temperature. At increased flow, the losses in the distribution system (pipes and fittings) increase, hence the pumps increase the pressure to compensate and vice versa, hereby maintaining an almost constant differential pressure across the thermostatic radiator valve.

The proportional-pressure mode setpoint depends on the heating system's characteristics and the actual heat demand.

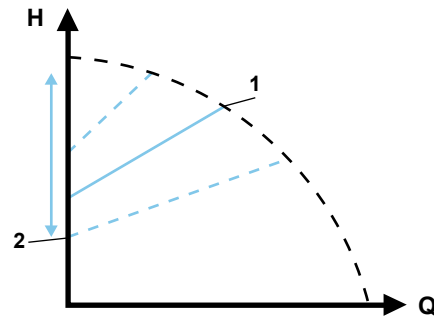

Pos.	Description
1	H_{set}
2	$H_{set} \times 0.40$

Related information

[9.1 Operating panel, UPSe](#)









[10.1 Settings according to system type](#)

10. Setting the product

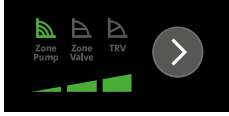
- Press the button to select control mode and setting.
The LEDs will indicate the control mode. See table below.

A cycle is nine button presses.

The factory setting is zone pump, setting III.

LED	Control mode
	TM082466 Zone pump, setting I
	TM082467 Zone pump, setting II
	TM082468 Zone pump, setting III (factory setting)
	TM082469 Zone valve, setting I
	TM082471 Zone valve, setting II
	TM082472 Zone valve, setting III
	TM082473 TRV, setting I
	TM082474 TRV, setting II
	TM082475 TRV, setting III

10.1 Settings according to system type

System	Recommended control mode
--------	--------------------------

Zone pump system

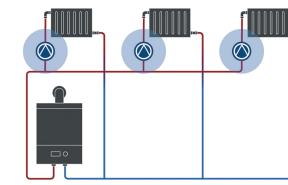

TM083013

Constant curve (zone pump)

Zone valve system

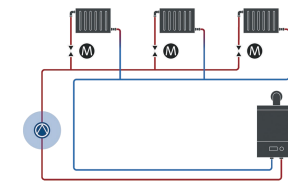

TM083012

Constant pressure (zone valve)

TRV system

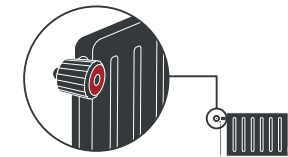

TM083015

Proportional pressure (TRV)

Underfloor heating with actuators

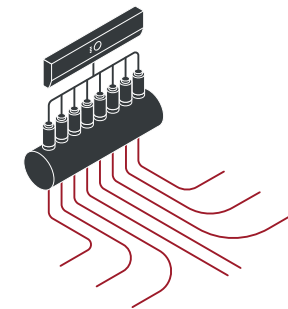

TM083014

Constant pressure (zone valve)

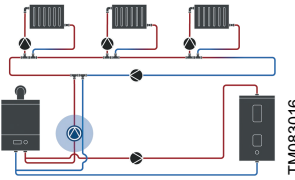
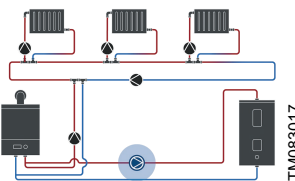
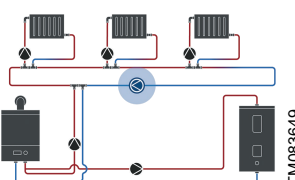
System	Recommended control mode
Boiler pump	Constant curve (zone pump)
	
Pump for indirect tank	Constant curve (zone pump)
	
Primary pump	Constant curve (zone pump)
	

Related information

[9.3.1 Constant curve \(zone pump\)](#)

[9.3.2 Constant pressure \(zone valve\)](#)

[9.3.3 Proportional pressure \(thermostatic radiator valve \(TRV\)\)](#)

11. Service

WARNING

Electric shock

Death or serious personal injury

- All electrical connections must be carried out by a qualified electrician in accordance with local regulations.



WARNING

Electric shock

Death or serious personal injury

- Switch off the power supply before you start any work on the product. Make sure that the power supply cannot be switched on accidentally.



WARNING

Electric shock

Death or serious personal injury

- A damaged product must be repaired or replaced by Grundfos or a service workshop authorized by Grundfos.



WARNING

Electric shock

Death or serious personal injury

- Connect the product only to a properly grounded receptacle.



WARNING

Pressurized system

Minor or moderate personal injury

- Before dismantling the pump, drain the system or close the isolating valves on both sides of the pump. Slowly loosen the screws and unpressurize the system. The pumped liquid may be scalding hot and under high pressure.



WARNING

Hot surface

Minor or moderate personal injury

- The pump housing may be hot due to the pumped liquid being scalding hot. Close the isolating valves on both sides of the pump and wait for the pump housing to cool down.



CAUTION

Sharp element

Minor or moderate personal injury

- Wear protective gloves.



CAUTION

Crushing of feet

Minor or moderate personal injury

- Wear safety shoes when moving the product.



CAUTION

Explosive environment

Minor or moderate personal injury

- Risk of explosion if the battery is replaced by an incorrect type.
- Dispose of used batteries according to the instructions.



11.1 Dismantling the product

Follow the steps below to dismantle the product:

1. Switch off the power supply.
2. Close the inlet and outlet valves.
3. Remove the lid from the conduit box, if applicable.
4. Pull out the power connector and disconnect the wires from the power connector.
5. Loosen and remove the conduit.
6. Loosen and remove the bolts from the pump flanges.
7. Remove the pump from the system.

Related information

[11.1.1 Disconnecting the wires](#)

11.1.1 Disconnecting the wires

Follow the steps below:

1. Switch off the power supply.
2. Remove the lid from the conduit box, if applicable.
3. Loosen the conduit.
4. Lift the orange levers to loosen the wires.
5. Pull the conduit out of the conduit box.

Related information

[7.1 Wiring the pump](#)

[11.1 Dismantling the product](#)

12. Fault finding

WARNING

Electric shock

Death or serious personal injury

- Switch off the power supply before you start any work on the product. Make sure that the power supply cannot be switched on accidentally.



WARNING

Electric shock

Death or serious personal injury

- A damaged product must be repaired or replaced by Grundfos or a service workshop authorized by Grundfos.



WARNING

Hot surface

Minor or moderate personal injury

- The pump housing may be hot due to the pumped liquid being scalding hot. Close the isolating valves on both sides of the pump and wait for the pump housing to cool down.



CAUTION

Pressurized system

Minor or moderate personal injury

- Before dismantling the pump, drain the system or close the isolating valves on both sides of the pump. The pumped liquid may be scalding hot and under high pressure.



12.1 Fault indication on the pump operating panel

Faults preventing the pump from operating properly are indicated on the operating panel with the warning and alarm symbol turning either yellow or red.

A warning is indicated with yellow. The pump does not perform as expected, and action is required in case of underheating or discomfort.

An alarm is indicated with red and the pump stops. Action is required.

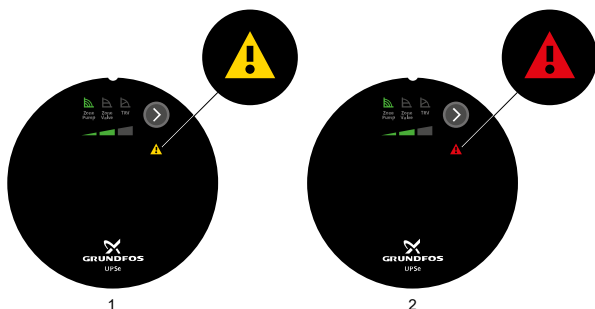



TM082502

Warning and alarm indication on the operating panel

Pos.	Description
1	Operating panel with a warning (yellow)
2	Operating panel with an alarm (red)

Fault chart

		
Dry running, stop		4 flashes
Blocked pump		1 flashes
Undervoltage (pump is running)	2 flashes	
Electrical fault	3 flashes	3 flashes

Related information

[9.2 Light fields indication](#)

[12.2 Dry running](#)

[12.3 Blocked pump](#)

[12.4 Undervoltage](#)

[12.6 Electrical fault](#)

12.2 Dry running

The warning and alarm symbol flashes red four times, and the pump stops.

Cause	Remedy
Insufficient water in the system or the system pressure is too low.	<ul style="list-style-type: none"> Fill the system with the correct amount of liquid to secure the system pressure.

Related information

[8.2 Dry-running protection](#)

12.3 Blocked pump

The warning and alarm symbol flashes red one time, and the pump stops.

Cause	Remedy
The pump is blocked by impurities.	<ol style="list-style-type: none"> Switch off the pump on the liquid side. Remove the pump head. Remove deposits.

12.4 Undervoltage

The warning and alarm symbol flashes yellow two times, and the pump continues to run.

Cause	Remedy
The supply voltage to the pump is too low.	<ul style="list-style-type: none"> Make sure the power supply is within the specified range.

12.5 Electrical fault

The warning and alarm symbol flashes yellow three times (warning), and the pump continues to run.

Cause	Remedy
Other pumps or sources create a flow through the pump even if the pump is stopped and switched off.	<ul style="list-style-type: none"> Check the system for defective non-return valves, and replace the valves if necessary. Check the system for correct position of the non-return valves.

12.6 Electrical fault

The warning and alarm symbol flashes red three times (alarm), and the pump stops.

Cause	Remedy
Internal fault.	<ul style="list-style-type: none"> Replace the pump.

12.7 Overheated boiler

Cause	Remedy
The flow is too low.	<ul style="list-style-type: none"> Increase the flow.

12.8 Noise in the system

Cause	Remedy
The flow is too high.	<ul style="list-style-type: none"> Lower the flow.

13. Technical data

Flow rate (Q)	Max. 13.6 gpm (3.1 m ³ /h)
Head (H)	Max. 19 ft (5.8 m)
Supply voltage	1 × 115 V, ± 10 %, 60 Hz
Motor protection	The pump requires no external motor protection.
Power usage (approximate)	Min.: 3 W Max.: 38 W
Enclosure class	Indoor use only. Enclosure type 2.
Insulation class	F
Ambient temperature	32-131 °F (0-55 °C)
Liquid temperature	36-230 °F (2-110 °C)
Relative humidity	Max. 95 %
Max. outlet pressure	175 psi (12 bars) (1.2 MPa)
Check valve	Use of a check valve reduces pump hydraulic performance.
Sound pressure level	< 25 dB(A)
Approvals	cULus and FCC. Complies to limits for class B digital device, pursuant to Part 15 of the FCC Rules.
Flange-to-flange length	6.5" (165 mm)
Pump housing	Electrocoated cast iron
Connection type	Flanged connection



The dew point of the air at ambient temperature must always be lower than the liquid temperature, otherwise condensation may form in the stator housing.

Inlet pressure

Liquid temperature [°F (°C)]	Minimum inlet pressure [psi (bar)]
167 (75)	0.75 (0.05)
203 (95)	7.25 (0.5)
230 (110)	15.7 (1.08)

14. Disposing of the product

This product or parts of it must be disposed of in an environmentally sound way.

1. Use the public or private waste collection service.
2. If this is not possible, contact the nearest Grundfos company or service workshop.

See also end-of-life information at www.grundfos.com/product-recycling.

15. Document quality feedback

To provide feedback about this document, scan the QR-code using your phone's camera or a QR code app.



[Click here to submit your feedback](#)

FEEDBACK92795807

U.S.A.

Global Headquarters for WU
856 Kooamey Road
Brookshire, Texas 77423 USA
Phone: +1-630-236-5500

GRUNDFOS CBS Inc.
902 Kooamey Road
Brookshire, TX 77423 USA
Phone: 281-994-2700
Toll Free: 1-800-955-5847
Fax: 1-800-945-4777

GRUNDFOS Pumps Corporation
9300 Loiret Boulevard
Lenexa, Kansas 66219 USA
Tel.: +1 913 227 3400
Fax: +1 913 227 3500

Canada

GRUNDFOS Canada inc.
2941 Brighton Road
Oakville, Ontario
L6H 6C9
Tel.: +1-905 829 9533
Fax: +1-905 829 9512

Mexico

Bombas GRUNDFOS de México
S.A. de C.V.
Boulevard TLC No. 15
Parque industrial Stiva Aeropuerto
Apodaca, N.L. 66600
Tel.: +52-81-8144 4000
Fax: +52-81-8144 4010

Revision Info

Last revised on 04-2021

92795807 09.2023
ECM: 1375412